

Technodiversity



Jörn Erler | Raffaele Spinelli | Stelian Alexandru Borz | Piotr S. Mederski

EDITOR: JÖRN ERLER

AUTHORS: JÖRN ERLER
RAFFAELE SPINELLI
STELIAN ALEXANDRU BORZ
PIOTR S. MEDERSKI

TECHNODIVERSITY



Transilvania
University
Press

2023

EDITURA UNIVERSITĂȚII TRANSILVANIA DIN BRAȘOV

Adresa: 500091 Brașov,
B-dul Iuliu Maniu 41A
Tel:0268 – 476050
Fax: 0268 476051
E-mail : editura@unitbv.ro

Copyright © Autorii, 2023

**Editură acreditată de CNCSIS
Adresa nr.1615 din 29 mai 2002**

Descrierea CIP a Bibliotecii Naționale a României

Technodiversity / Jörn Erler (ed.), Raffaele Spinelli, Stelian
Alexandru Borz, Piotr S. Medersk. - Brașov : Editura Universității
"Transilvania" din Brașov, 2023

Conține bibliografie
ISBN 978-606-19-1636-8

- I. Erler, Jörn
- II. Spinelli, Raffaele
- III. Borz, Stelian Alexandru
- IV. Mederski, Piotr S.

62



TECHNODIVERSITY IN FOREST OPERATIONS

Jörn Erler, Raffaele Spinelli, Stelian Alexandru Borz, Piotr S. Mederski

A product of the ERASMUS+ project

Technodiversity: Harmonising European education in forest engineering by implementing an e-learning platform to support adaptation and evaluation of forest operations

project No. 2021-1-DE01-KA220-HED-000032038

The aim of the project is to show and explain the technological diversity in harvesting operations and to promote it through targeted training. For this purpose, a barrier free knowledge platform is built, containing:

- an e-learning course about decision-making to find the best technical solution for forest harvesting,
- scientific audiovisuals that show and explain forest operations with a common didactical standard,
- additional information about forest techniques of the partners.

The platform is aimed at forest students on master's level as well as for practitioners for life-long learning.

technodiversity-moodle.ibe.cnr.it



Members of the project team:

- **Dresden University of Technology**, Germany (leader), prof. Jörn Erler, PhD, Christina Spirow, M.A. and Clara Bade, BSc
- **Poznań University of Life Sciences**, Poland, prof. Piotr S. Mederski, PhD and Mariusz Bembenek, PhD
- **National Research Council**, Italy, Raffaele Spinelli, PhD, Natascia Magagnotti, PhD and Marco Simonetti, MSc
- **Transilvania University of Braşov**, Romania, prof. Stelian A. Borz, PhD
- **University of Natural Resources and Life Sciences**, Austria, prof. Karl Stampfer, PhD
- **Swedish University of Agricultural Sciences**, Sweden, prof. Ola Lindroos, PhD and Mikael Lundbäck, PhD
- **Faculty of Forestry and Wood Technology University of Zagreb**, Croatia, assist. prof. Andreja Đuka, PhD and assist. prof. Ivica Papa, PhD
- **Technological Institute FCBA**, France, Nathalie Mionetto, PhD and Philippe Ruch, forest research engineer

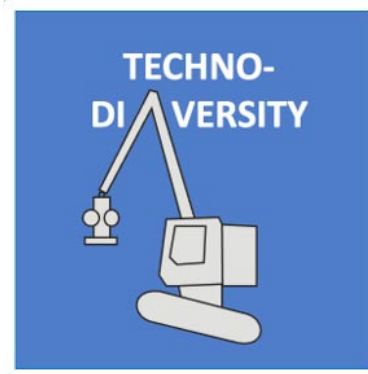

**Erasmus+ programme Action Type KA220-HED
– Cooperation partnerships in higher education**

This book is an excerpt from the e-learning course, supplemented with brief portraits of the most important sub-processes.

The creation of these resources has been (partially) funded by the ERASMUS+ grant program of the European Union under grant no. 2021-1-DE01-KA220-HED-000032038. Neither the European Commission nor the project's national funding agency DAAD are responsible for the content or liable for any losses or damage resulting of the use of these resources.



**Transilvania
University
Press**



Text: Prof. Jörn Erler, PhD, and Raffaele Spinelli, PhD

Cover: Christian Knobloch, PhD

Layout: Christian Knobloch, PhD

Editor: Prof. Jörn Erler, PhD

Copyright by the authors

Print: Transilvania University Press

09/2023

ISBN 978-606-19-1636-8



A02 What is the role of forests?

- For most people, nature is for free, and everybody can use it if they need. As a matter of fact, forest ecosystems offer to the human society a wide range of free **benefits**, which humans obtain without needing to make any efforts or invest any work. Among them, air and water quality, climate mitigation, soil protection etc.

What is the role of forestry?

Additional benefits can be obtained by investing work in the forest – i. e. cultivating it in order to obtain goods and services, like timber, game, non-wood products etc. But there is a limit to all uses: when people use more timber than the forest can grow, when they burn the bush and exploit the soil... the benefits are reduced over time and eventually lost.

That is why human society needs specialists, who take care of the woodlands and guarantee a permanent supply of forest products and services. That is the birth of forestry. Its main task is sustainable forest utilization through forest management.

What is the role of a forest company?

Within this context, the individual forest company has two tasks:

- 1st direct: To supply **goods and services** to society.
- 2nd indirect: To maintain and develop the woodland in a way that will improve its efficiency and maximize its benefits to society.

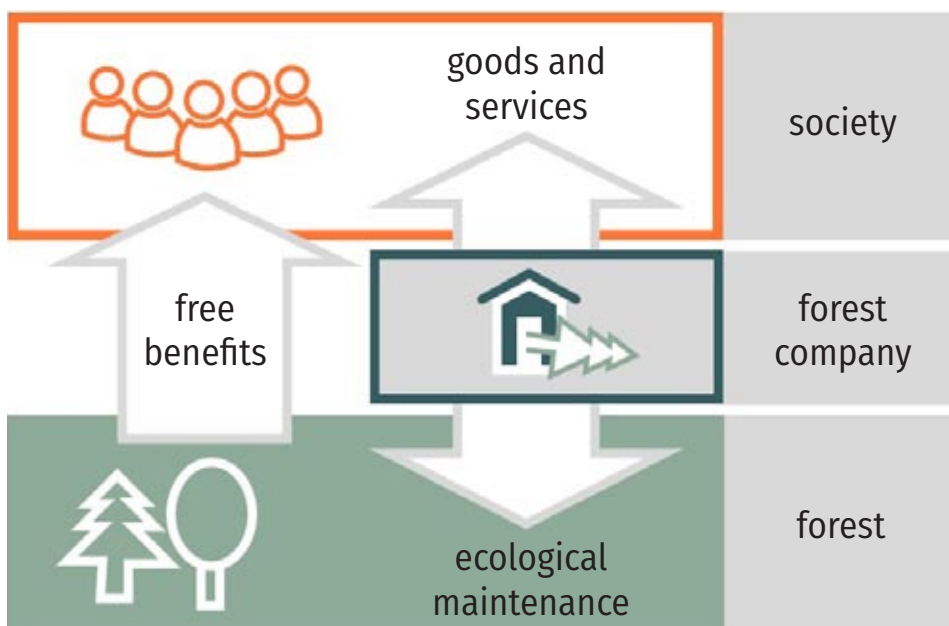

Figure 1: The role of a forest company

A	THE BASIC CONCEPTS OF TECHNODIVERSITY	4
	Do we need diversity in forest techniques?	4
	What is the role of forests?	5
	Assessment criteria	7
	Decision making in three steps	10
	System theory as basic concept	12
B	HARVESTING CHAINS – DESCRIPTION AND CLASSIFICATION	14
	Functions of harvesting	15
	Sub-functions of harvesting	17
	Tools and machines for harvesting	20
	Degree of mechanization	24
	Degree of mechanization with composed systems	29
	The functiogram	31
	Process chaining	34
C	ECONOMIC SUITABILITY	36
	Economic criteria	37
	Machine cost calculation	39
	Productivity	45
	Additional costs	48
	Total system costs, exceptions	49
D	ECOLOGICAL SUITABILITY	51
	Risks, side-effects, and damage	52
	Damage to forest soils	57
	Soil repair and prevention	62
	Avoiding soil damage	64
	Solutions for trafficable areas	68
E	SOCIAL SUITABILITY	72
	Societal compatibility	73
	Working stress	77
	Strain at work	78
	Social suitability	81
F	PATH TO THE OPTIMAL SOLUTION	84
	Selecting the best option	85
	Target driven optimality	88
G	PORTRAITS OF SUB-PROCESSES	97
H	INDEX	170



A THE BASIC CONCEPTS OF TECHNODIVERSITY

A01 Do we need diversity in forest techniques?

Our thesis is:

Harvesting operations should optimally match

- the technical potential and personal capacities of the user
- the environmental and social conditions of the site
- the objectives of the forest owner.

Technodiversity explains how to select the most suitable harvesting technique for each given case, based on clear objective elements.



A comment on the role of a forest company

But from the point of view of the forest company? Isn't it that the overarching task of every company is to **maximize the income** of the owner? Yes and no. Because we must make a difference between the material objective and the formal objective:

The material objective of any forest and herewith also for every forest owner is to care for the forest and to deliver services and goods in a sustainable way. This defines the typical character of this branch of forestry, its restrictions, and limitations.

The manager of the forest must regard all these restrictions and limitations. There is no leeway; if he fails, he can be punished. But inside these restrictions and natural limitations, different options are given to optimize the success. Choosing the best option is the original job of the manager. But what is the best? Here the overarching task may be to maximize the income of the owner, but in some cases, there are diverging priorities. The success of the manager is measured on the background of this formal objective.

What is the role of forest techniques?

Inside this frame, techniques have the task to implement what the company needs. So, a technique is good as far as it achieves the intended effects while minimizing undesirable side-effects and risks.

Now, we see that the intended effects have three directions:

- towards society to deliver those goods and services that are demanded > **social efforts**
- towards woodlands to maintain them and to improve their health, if needed > **ecological efforts**
- towards the forest company itself to keep its value and to fulfill the needs of its owners > **economic efforts** as well.



Figure 2: The role of forest techniques



A03 Assessment criteria

The goals of a company

The objectives of a forest company can be divided into three groups: economic, ecological and social objectives.

All actions are to be assessed based on how these three objectives are met. Here very often we find cause-and-effect logics that can be assessed with scientific methods. Consequently, we call this process **assessment**.

The ultimate goal of the company determines which objective is the most important (priority) and how the objectives are weighted against each other (preference). This depends on the individual wishes and sometimes the political aims of the decision maker... and is far away from scientific routines and methods. But very often, the ultimate goal influences the decision making process more than the scientific cause-and-effect logics. Therefore, we would make a mistake not to take into account this individual “color“ of decision making. We call it “evaluation“.

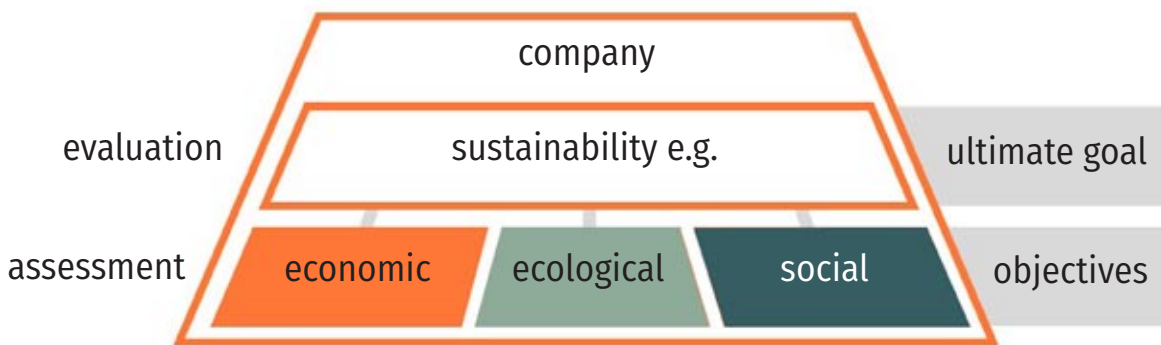

Figure 3: Basic model for decision-making: The company has a common system of competing objectives that together form the ultimate goal (here as example sustainability). For each objective, options can be assessed against the objective. Combining all assessments to one common value is called evaluation.

The concept of breaking down

This system of objectives remains on an abstract level and is not concrete enough for certain decision-making tasks. To solve this problem, we can break this system of objectives down to a subsystem, which is specially designed for making decisions about forest techniques.

The relationship between an objective and its corresponding sub-objective is functional: Does the means achieve the objective? Is it suitable?

The sub-objectives: to be suitable

Concerning the forest technology, the technical means should be:

- Economically suitable > **meeting the needs of the company**
- Ecologically suitable > **meeting the needs of the environment**
- Socially suitable > **careful and acceptable for the local society**

Optimality, a combination of effectiveness and efficiency

To be suitable means that we are looking for the optimal solution; **“optimal”** in a way that we look for that means that achieves best the objective. But unfortunately, we seldom recognize, which solution is optimal, because it is less obvious than we wish. So, we need to make a detour.

First, we should ask, whether we will be able to reach the effect that we aim for. Or, more academic, what will be the effect of using these two options on the background of our objective? Is there an option, by which we will not be able to reach it? If so, it is clear that the other option will be the winner. But if both options come to a comparable end, the effect of both options is identical. Thus, when we ask whether the effect fulfills the objective, we call it **“effectiveness”**.

Let's assume that both options lead to a comparable effect. Then we feel the need to take the option, which demands for the lowest input. In general, looking for that means that reaches the same effect with the lowest input is called **“efficiency”**.

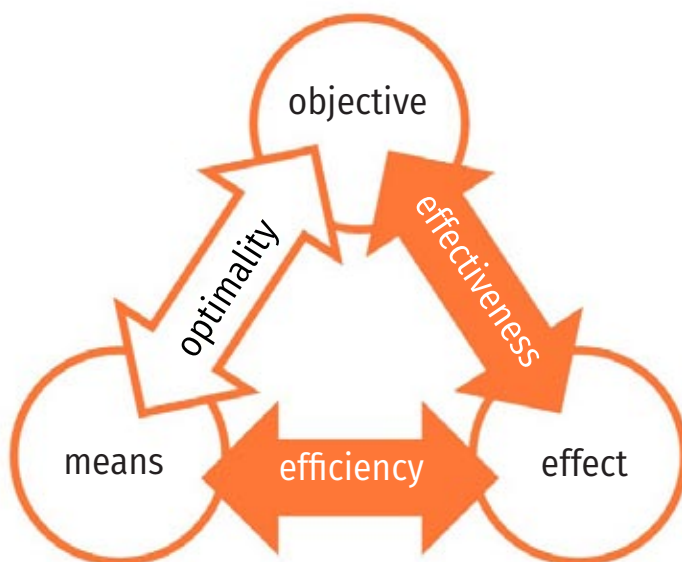

Figure 4: Optimality, a combination of effectiveness and efficiency



Three times effectiveness

For each sub-objective we need to find one definition for the effectiveness and another one for efficiency. Thus, we get exactly six criteria for decision making; we call them the partial objectives.

- Economic effectiveness: what does the company want to achieve? > **Effectiveness**
- Ecological effectiveness: how to minimize the ecological risks and undesirable side-effects? > **Ecological compatibility**
- Societal effectiveness: how can we minimize any conflicts with societal needs > **Societal compatibility**

Three times efficiency

- Economic efficiency: with which means do we achieve the highest profit? > **Efficiency**
- Ecological efficiency: how can we minimize the ecological input? > **Eco-efficiency**
- Societal efficiency: how can we minimize the strain and stress of workers? > **Ergonomics**

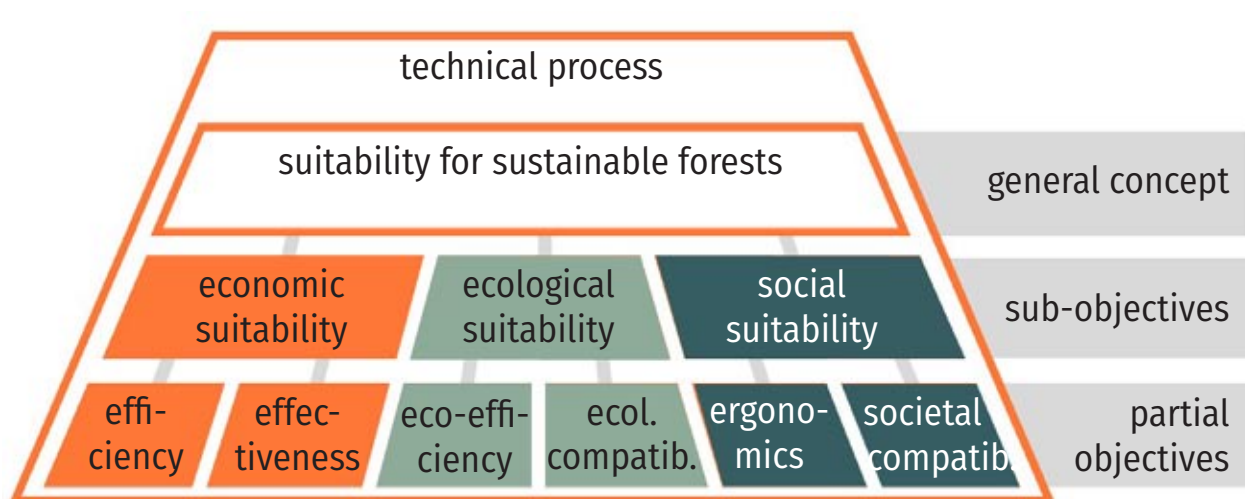

Figure 5: Breaking down of sub-objectives and partial objectives from the set of objectives of a company



A04 Decision making in three steps

New and old technical options

Techniques are mostly identified by machines or equipment. If there are more than one options, we should ask ourselves whether this equipment really fits our own conditions, tree species, tree size, soils, inclination etc.

Furthermore, all equipment must be operated by skilled professionals. Do we have access to suitable operators? And to the technical infrastructure needed to maintain the new machines?

The outcome is paramount

As soon as we have two or more options, we must decide which one will be best. Crucial for decision making are the expected productivity, cost, impact etc. We look for effectiveness and efficiency. Until we can experience them, we must try to predict them.

And there is one important option that we always have: to do nothing. We call that the **“zero option”**. The zero option also has effects, which can be compared with the effects of the other options.

Is the option acceptable under your local conditions?

Sometimes a technically viable solution conflicts with local traditions and laws, local culture or societal needs. If so, do you really dare to evoke these conflicts? Other times, that solution inflicts damage in the forest stand and/or the soil. In that case: Will this solution be good in the long run?

Under the remaining options: which one is the best?

The final decision is made for the best among the remaining options. In most cases, that decision is not solely based on objective rules but also on subjective preferences. In all cases, we may want to know how a decision is reached.

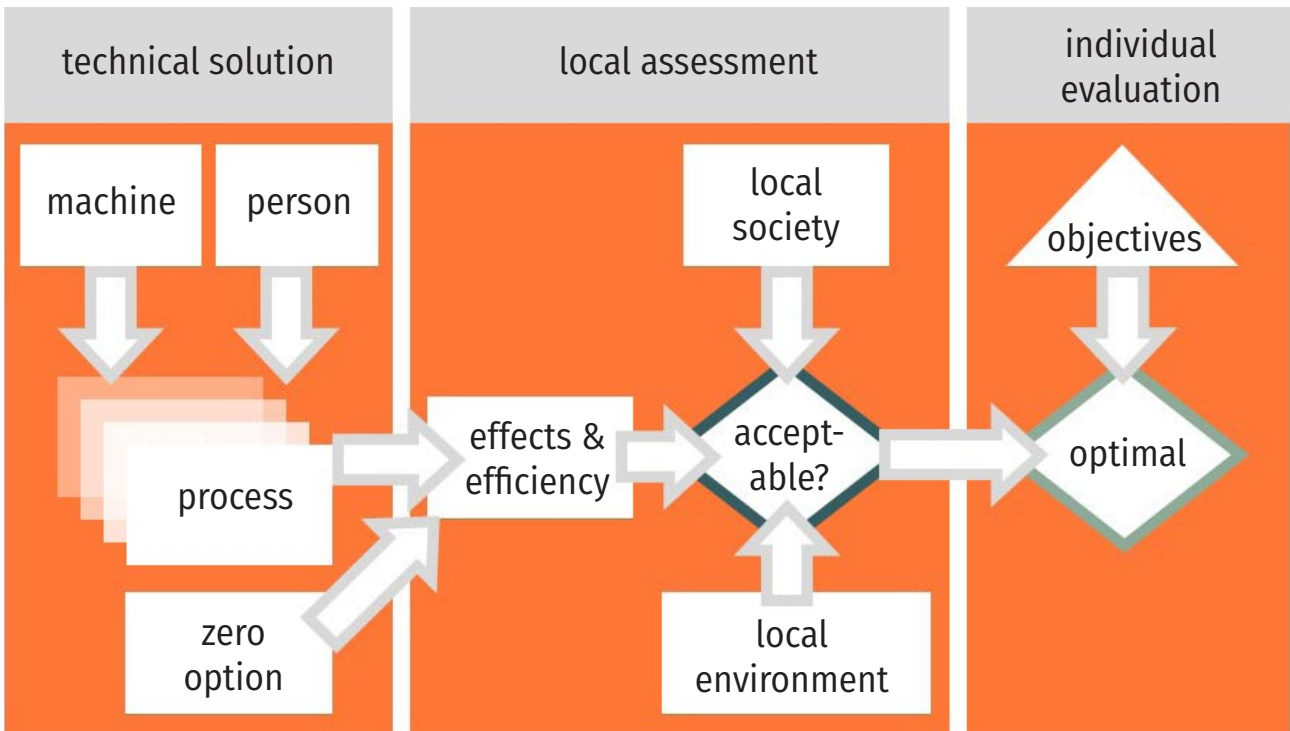

Figure 6: Three steps of decision making in forest techniques; the basic model of the Technodiversity project

Three steps of decision making

- The **first step** aims at finding and designing all harvesting processes that can work under local conditions and technical constraints of the stand... without forgetting the zero-option.
- The **second step** checks for any local constraints to their deployment and leads to the exclusion of non-compatible options.
- In the **third step**, one extracts from the remaining processes that one that offers the best fit with the individual aims of the decision-maker.



A05 System theory as basic concept

Forest techniques can be seen as a system. Systems can be regarded in different ways:

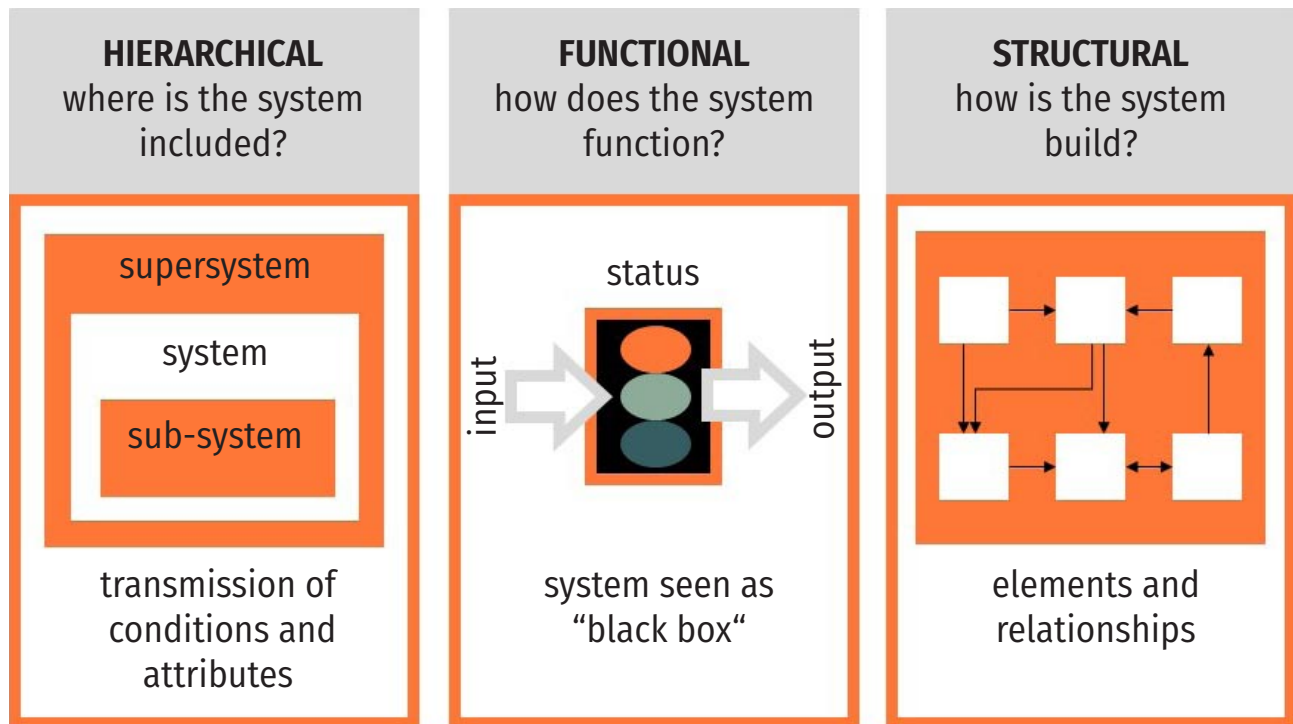

Figure 7: Three different system approaches

Functional system approach

The functional system approach:

- It does not focus on technical details, but on if-then-rules.
- The system itself is more or less a black box, which can be described by:
 - **Input** entities, such as: material, energy and information
 - **Output** entities (again material, energy and information)
 - And the **status** of the system, in our case whether it is switched off, powered on or in stand-by mode.

For Technodiversity, we use this approach to describe the **functions** of harvesting methods.

Corresponding with the theory of labor analysis using time studies, we will describe functions as a process between the status of the system at the beginning of the working circle and the status at its end. So, you can say that the functional system approach reflects the dynamics of a process.



Structural system approach

Instead, the structural approach deals more with the statics. In Technodiversity, we use this approach to define the **degree of mechanization** asking which tasks are performed by the machine and which ones by its operator. Both approaches are complementary:

- The functional approach says what the system is able to do.
- The structural approach explains how it does it.

Hierarchical system approach

Finally, another possible approach is the hierarchical one.

- The technical system is integrated in the **decision-making hierarchy** of the forest company. Thus, its supersystem is the forest company.
- The manager is leading several departments – they are the sub-systems of his management area. All department heads must follow the manager's instructions – the sub-systems inherit the conditions, attributes, and decisions of the company (supersystem) they belong.

Levels of decision making

Who needs to know about optimization of forest operations?

- The persons who define the objectives and the relationships between them. Like the forest owner, e. g.; he produces an overall vision and issues general guidelines. Since these guidelines must be obeyed by all other levels in the line, this level is called **normative**.
- The persons who decide about investments in tools, machines, and workforce. Like a forest district officer, e. g.; he develops the resources to solve future problems. Here the switch points for the future are set, so we call it the **strategic level**.
- The persons who decide about the choice of tools, machines, and workforce in practical situations. Like a local forester, e. g.; he uses the available resources to solve practical problems. We call this the **tactical level**.
- The persons who use the tools and machines to perform the assigned tasks. Like a skilled forest worker, for example; he is responsible for fulfilling the assigned tasks. Because this happens during the operation as such, we call it the **operational level**.



Figure 8: Four levels of decision making

B HARVESTING CHAINS – DESCRIPTION AND CLASSIFICATION

Chapter B has the task to find technical solutions that work under the local conditions and can be managed and maintained by the local staff.

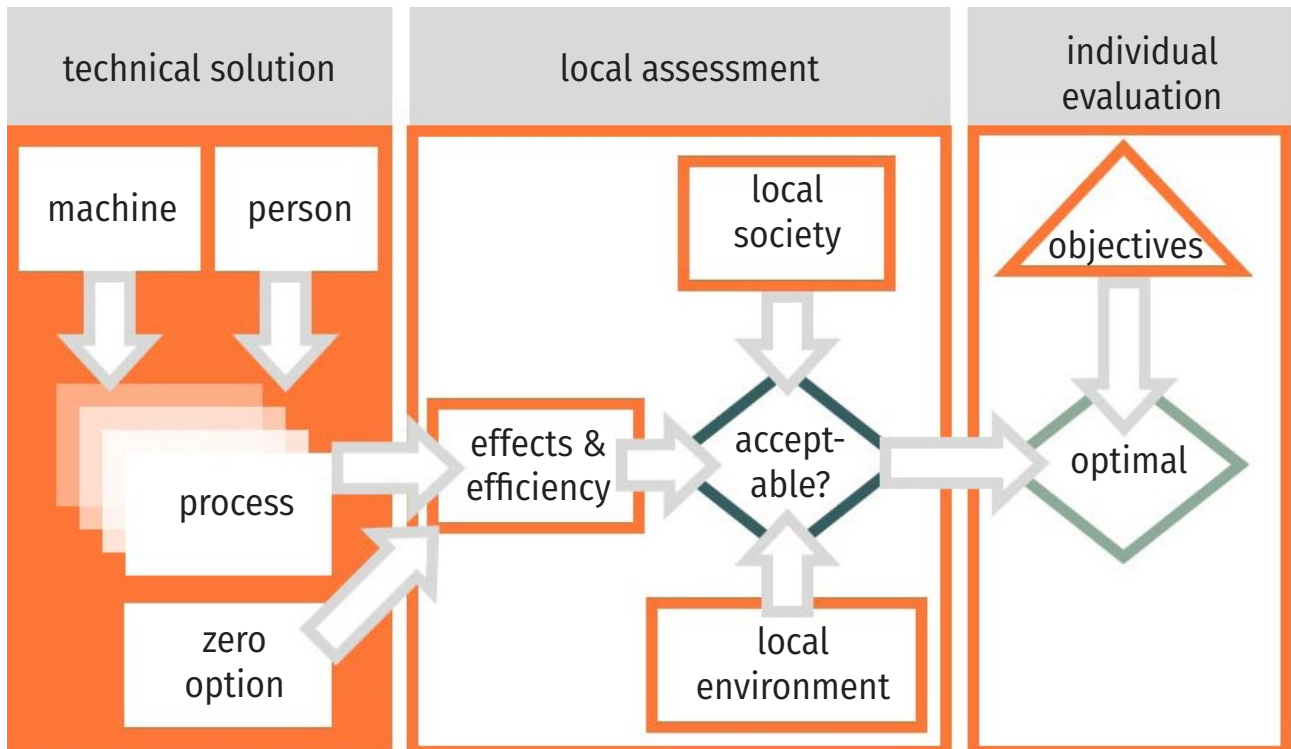

Figure 9: The part of chapter B in the three-step model of decision making is to find and characterize “technical solutions“ (left part in the figure)



B01 Functions of harvesting

Machines and sub-processes are generally well described, through suitable common terminology. But there is a need for common terminology when it comes to the overall process. The terminology presented here looks for terms that are as self-explanatory as possible.

It is obvious, that harvesters and forwarders, e. g., have different functions. We are now moving to the functional system approach. With this approach we ask ‘what happens...?’

How will the system react if it is in a certain state and we act in a certain way? We don’t need to understand how it will make it happen: we just need to know the result. The inner functioning of the system itself remains a black box.

- According to system theory, there are three input types, and namely: **information (i)**, **energy (e)**, and **materials (m)**. And the outputs are, again: information (i), energy (e), and materials (m).

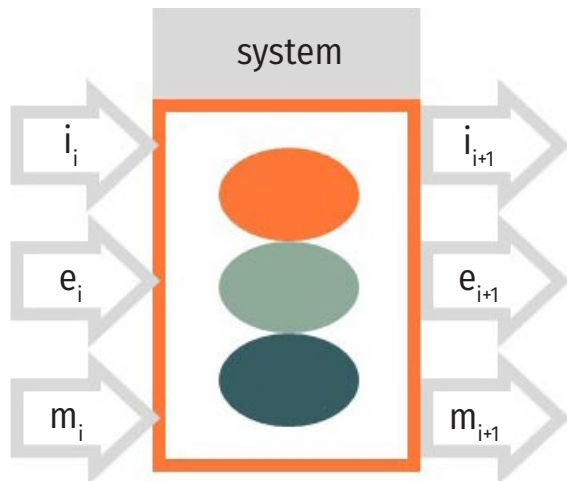

Figure 10: The functional system approach (with the entities i = information, e = energy, and m = material as categories left as input and right as output and darkgreen = on, light green = stand-by and orange = off)

How inputs are processed into outputs, depends on the state of the black box. In the case of the harvester-forwarder system, for example, we have two main functions assigned to the two distinct machines:

- Felling and processing: **harvester**
- Extraction: **forwarder** (and when you look very closely, the harvester makes a short extraction, too)

Felling and processing

Felling and processing = the characteristics (**state**) of the work object are modified. In our example, the work object is converted from a single tree into one or more logs, through the following actions:

- Felling
- Delimiting
- Cross cutting, topping
- Chipping

Extraction

Extraction = now, the **location** of the work object is changed. What was located inside the forest is moved to the roadside. This process can be direct, or split into sub-processes that are occasionally performed with different machines and/or at different times, such as

- Bunching, pre-skidding or lateral yarding: when the work object is moved from inside the forest to a strip road, trail or corridor..
- Skidding, forwarding or yarding: when the work object is moved from the strip road, trail or corridor to the forest road.

Auxiliary functions

In addition, there are auxiliary functions like

- handling (physically) and
- controlling (intellectually).

They also describe some important functions, but we will skip them for the moment.





B02 Sub-functions of harvesting

The steps in the process of **object state change**.

The function of timber processing can be divided into several sub-functions like

- Felling
- Delimiting
- Cross-cutting
- Chipping

These steps can concatenate seamlessly or be interrupted by buffers. In case of a buffer, the product is stored, and a new process cycle starts.

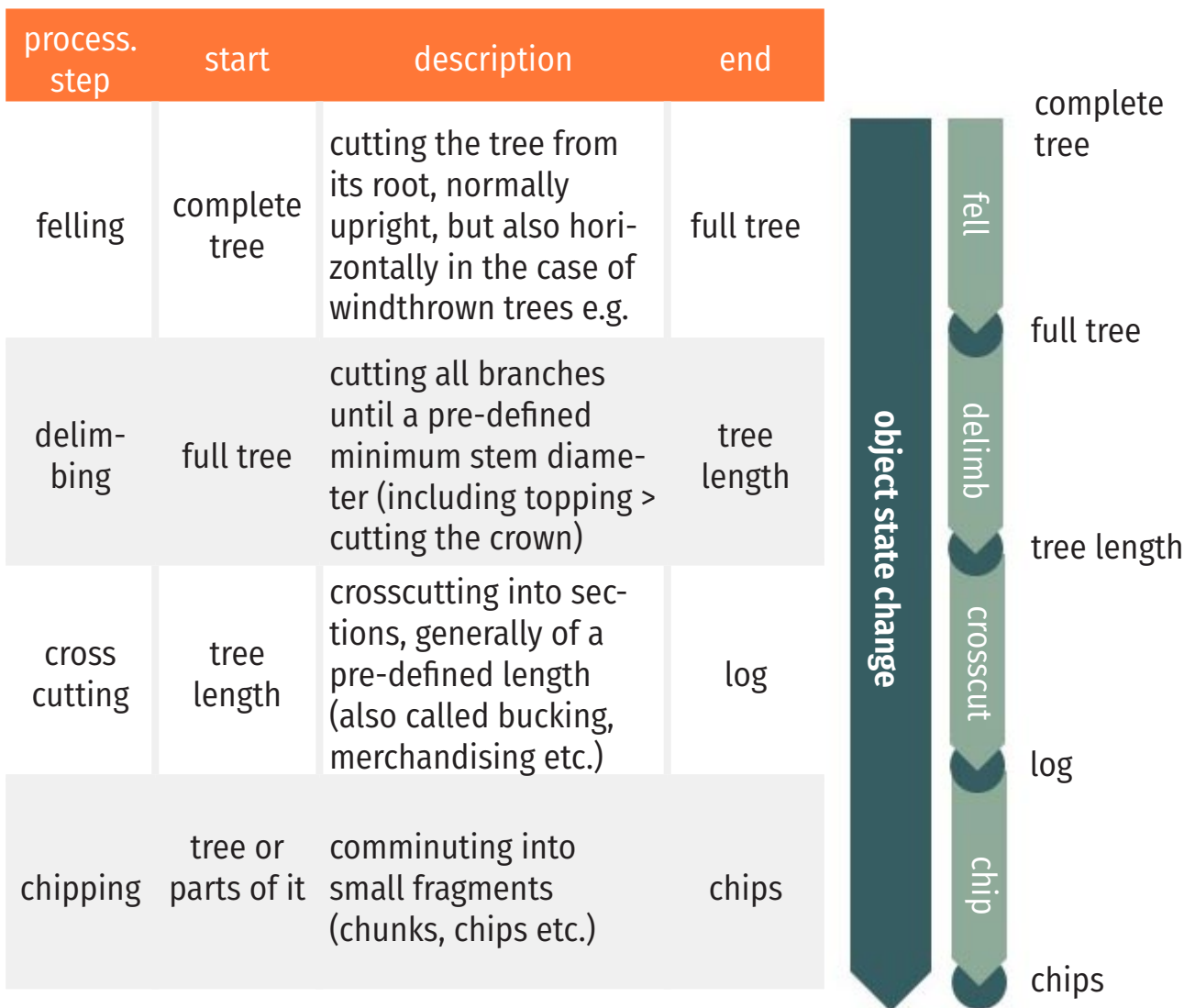

Figure 11: Steps in the process of object state change

The steps in the process of location change

Until now, the location of the action did not matter at all. But there can be different locations:

Things can happen

- directly at the felling site in the stand
- or on trails, strip roads, or corridors, while
 - a trail is a path on the unprepared forest floor where the extraction of the logs take place
 - a strip road is a bit more prepared for this purpose
 - a corridor is an open space for extraction where the logs are transported by means of a cable
- or on the forest road that is strong enough to sustain trucks without off-road attributes.

process. step	start	description	end
pre-skidding	felling site	moving from the felling site to any site that can be reached by an off-road extracting vehicle	trail, strip road or corridor
extraction	trail, strip road or corridor	moving along the trail, strip road or corridor until reaching the forest road; skidding = product is dragged forwarding = is carried yarding = is suspended	forest road
transport	forest road	transportation by truck, train or ship	factory

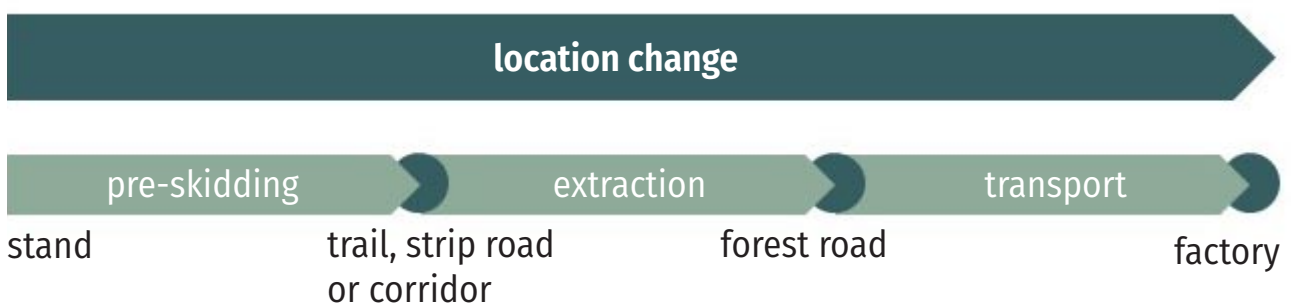

Figure 12: Steps in the process of location change



The action to bring the logs from the felling site to the storage point at the forest road is called the location change.

Location change can happen in several steps. Very seldom these steps concatenate seamlessly: normally they are interrupted by some buffers.

As a product reaches the **buffer**, it is stored there while it waits for the next step in the position change process.



B03 Tools and machines for harvesting

Tools and machines for object state change

These tools divide the single work object into more parts using one of the two following principles:

- **Cutting**, when the sum of the parts is identical with the original total and the division is obtained by a compression or a shearing force.
- **Sawing**, when division into more parts is obtained by digging away a small portion of the total, which is lost (kerf). Therefore, the sum of the parts is no longer identical to the original total.

Here are some examples of tools for manual work: Axe, machete, bush-knife, hand-saw. Today, people often use a chain saw; we call it motor-manual work. However, the fastest and safest solution is mechanized work.

technical principle	manual	motor-manual	mechanized
cut	axe, machete, bushknife		
saw	hand saw	chain saw	feller
			processor
			harvester

Figure 13: Tools and machines for object state change



For the sake of clarity:

- Fellers only fell (and bunch)
- Processors only delimb and cross-cut, but cannot fell
- Harvesters can do all those jobs in one smooth pass.

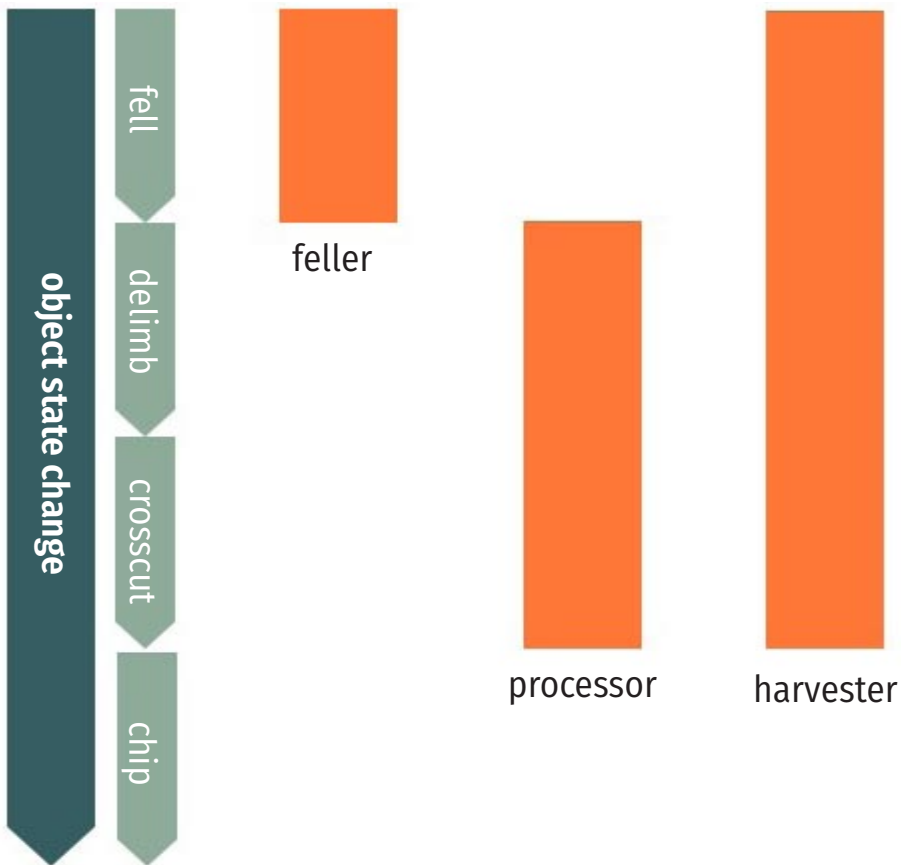

Figure 14: Functional differentiation between feller, processor, and harvester

Functionality of different machines for location change

The second main function of harvesting is location change. This function can be divided into

- Pre-skidding
- Extraction
- Transport

Tools and machines for pre-skidding

Pre-skidding means to move the work object from its primary location inside the stand to the nearest spot accessible to the extraction vehicle. This can be

- a skid road in case of skidder,
- a strip road in case of forwarder,
- or a corridor with a cable yarder.

In general, we call it trail.

If the primary location is already accessible to the extraction vehicle, no pre-skidding is necessary.

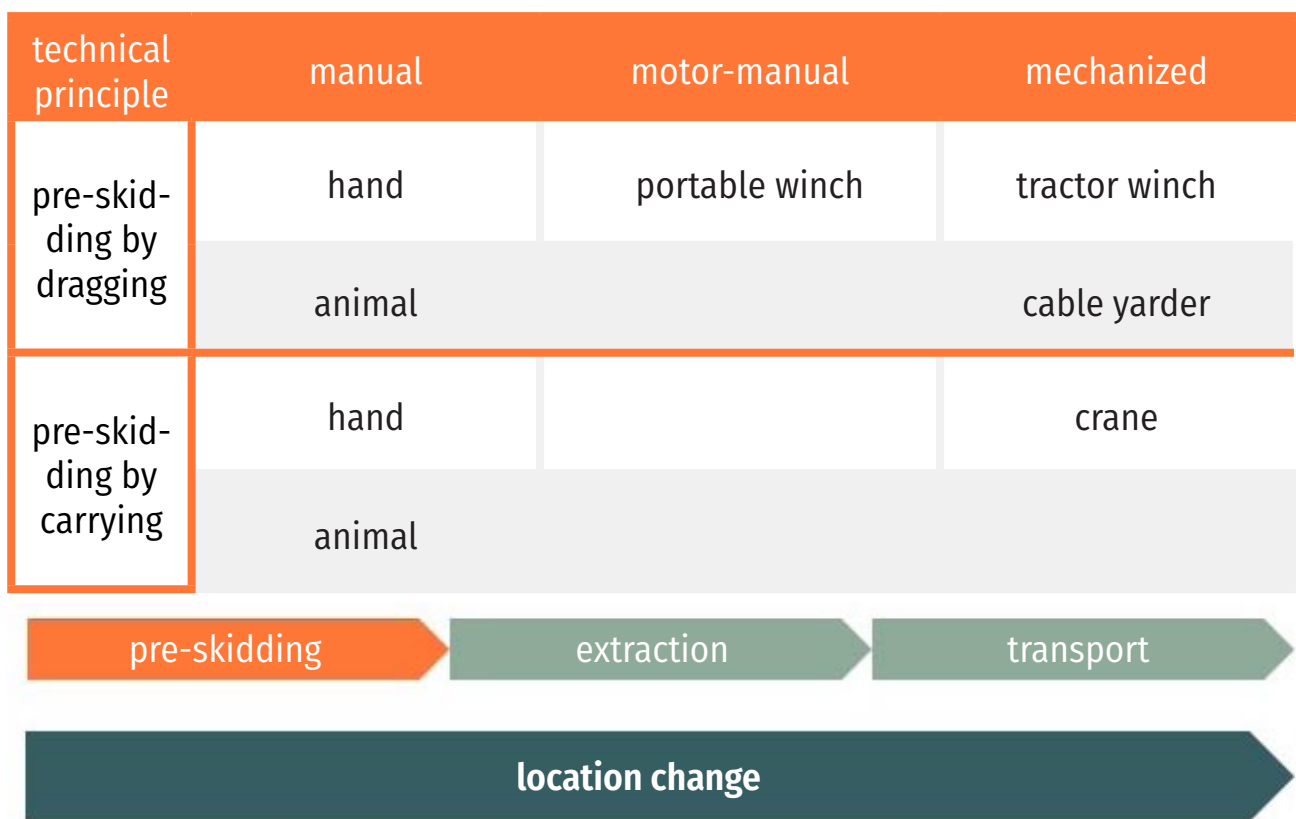

Figure 15: Tools and machines for pre-skidding



Tools and machines for extraction

Timber must be moved from inside the stand to a road, where it can be loaded on trucks for delivering to the factory. Moving it from the stand to the road can be done by one machine in one single step if all of the forest stand is accessible to that machine.

Like with pre-skidding, the extraction can again be achieved by two main principles:

- Dragging – the object is in contact with the terrain all along (i.e. skidding)
- Carrying – the object is lifted off the terrain (i.e. forwarding and yarding)

Pre-skidding and extraction can be done by one machine in one single step if all areas of the stand are accessible to that machine.

In (European) practice, skidding, forwarding, and yarding are realized only by machine work.

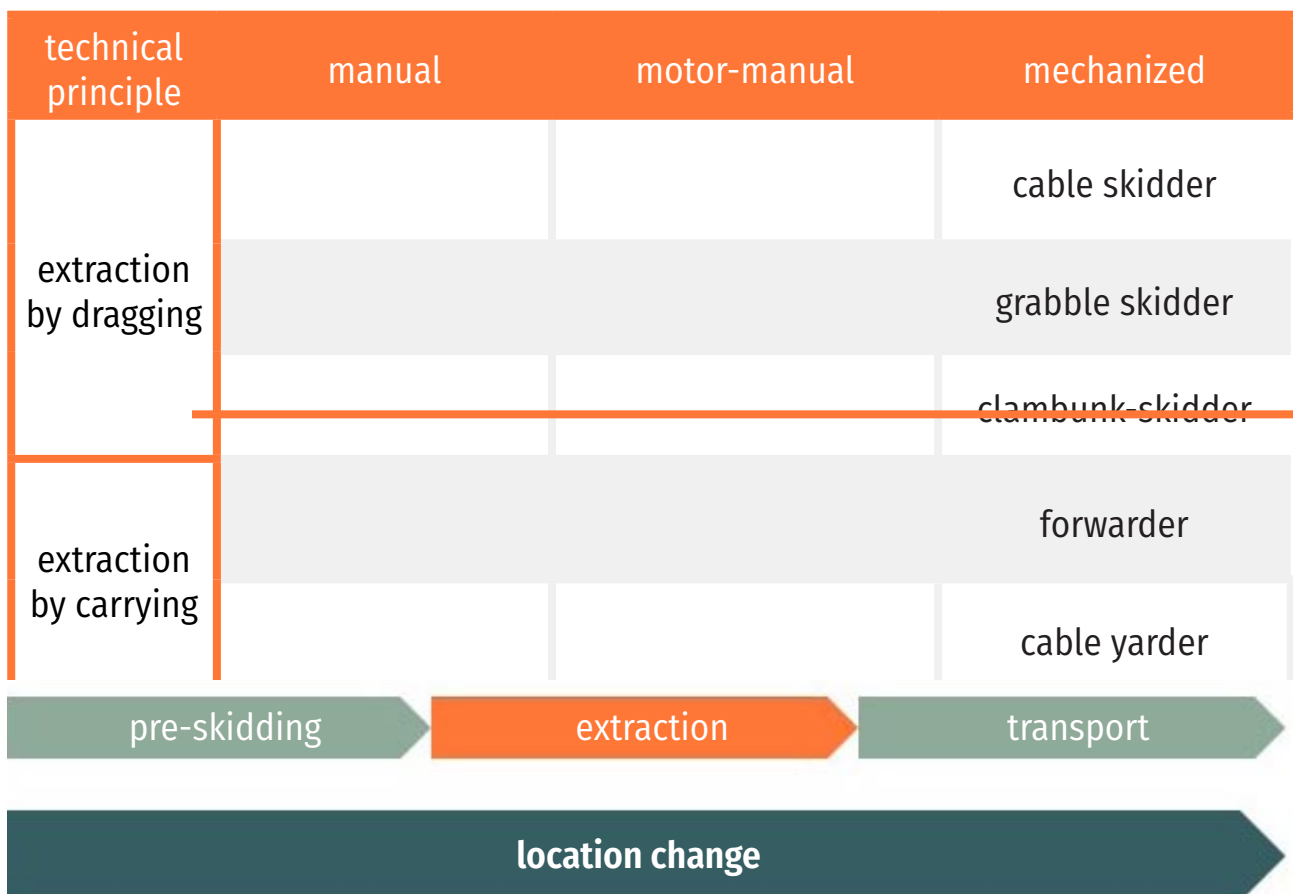

Figure 16: Tools and machines for extraction



B04 Degree of mechanization

The basic structure of a working process

In order to define the terms manual, motor-manual and mechanized work, we use a simple model of the working system based on the structural approach. In this model, work has three levels:

- Tangible work is done at the **operational level**.
- Work is controlled at the **informational level**.
- Objectives are set at the **aim-oriented level**.

The basic two boxes can be sub-divided into four small boxes each.

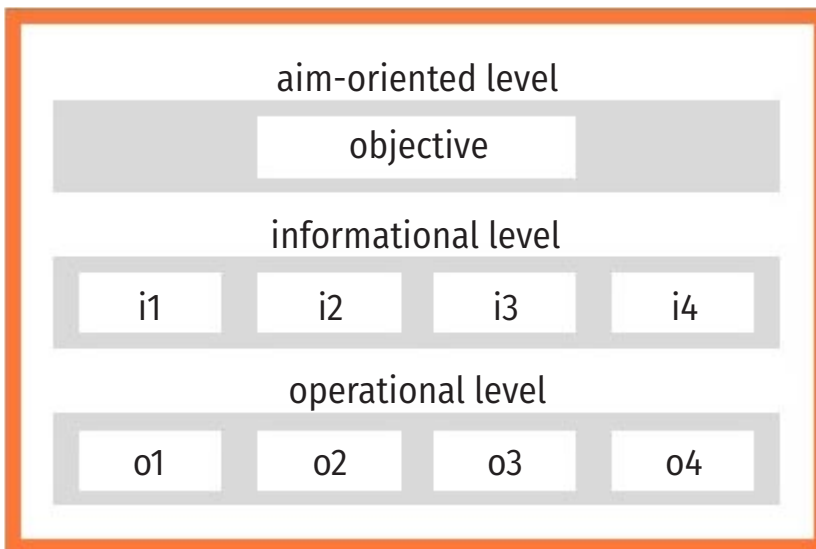

Figure 17: Basic model of the work structure on the basis of Ropohl 1979

- i4 driverless operations
- i3 automation of sub-operations
- i2 control assistance
- i1 information assistance
- o4 handling of the work object
- o3 navigation of the tool
- o2 source of working energy
- o1 impact on the work object

For every small box there are only two alternatives: The work can be performed by human (= white color) or by machine (orange color).



Manual work

If the action is done by workers using just their own force (and at most a hand tool), then we call it manual work. The use of animals is not manual work proper, since workers do not use their own force to perform the action. But we shall include it into the manual work category for the sake of simplicity.

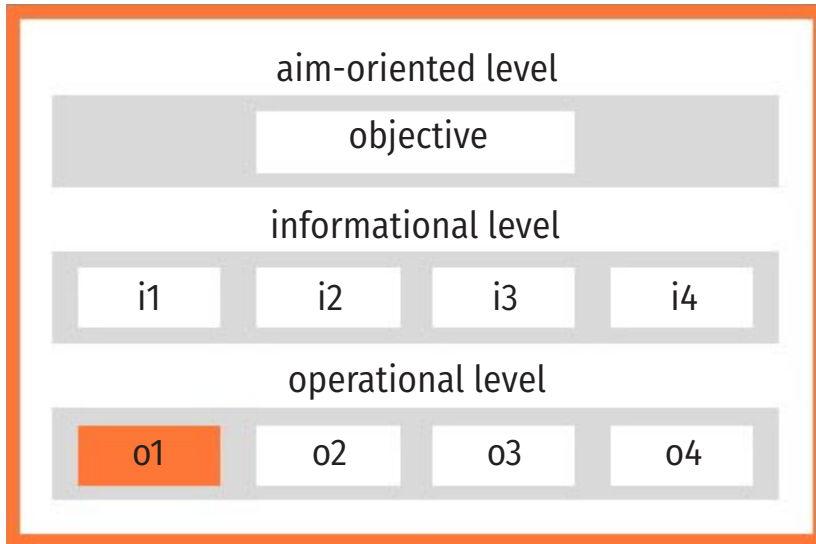

Figure 18: Manual work; at the most a tool can be used to make any impact to the object (=o1), the rest is done by human
white color > performed by human; orange color > performed by a tool or machine

Motor-manual work

Because manual work is tiresome, people have always looked for some external source of power. In modern times, the obvious step is to use an engine to drive the tool – hence the appearance of portable machines. In forestry we call that “motor-manual work“. With motor-manual work, two elements of the operational level are taken over by the machine:

- o1 impact on the work object
- o2 source of the working energy.

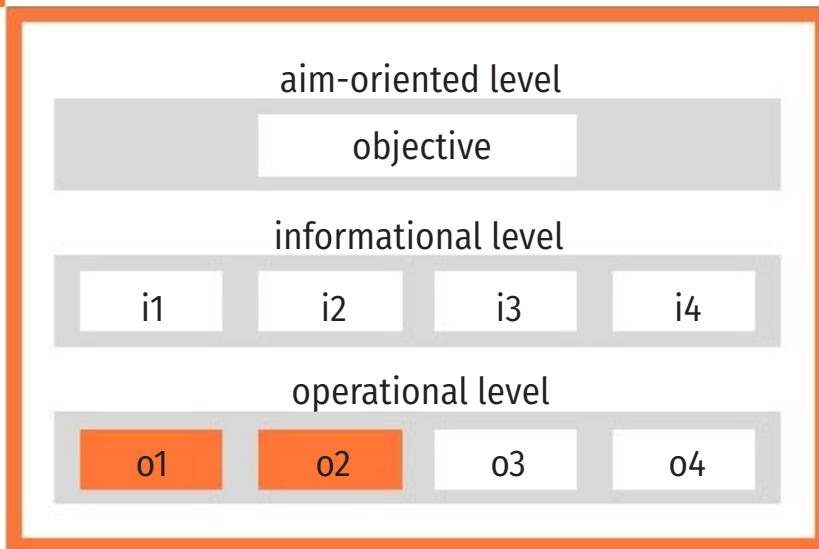

Figure 19: Motor-manual work; the impact to the object and the energy are coming from the machine

white color > performed by human; orange color > performed by a tool or machine

Mechanized work

When the engine is no longer portable but needs a carrier, we call that mechanized work. Because the weight of the machine is no longer limited by the weak carrying power of humans, the machine can be developed apparently without any mass restrictions.

With mechanized work, at least three elements are taken over by the machine

- o1 impact on the work object
- o2 source of the working energy
- o3 navigation of the work tool.

If more than these three elements are taken over by the machine, it remains still mechanized work. Before electronics were involved, this seemed to be enough. Now we feel, that mechanized work should be more differentiated.

Simple mechanized work includes these three elements only. It offers increased power and mobility, but all auxiliary functions are done by humans. Example: a cable skidder can move larger loads than a human can, and does that at a higher speed. But the attachment of the logs must be done manually by the operator.

When the machine also takes over the auxiliary function to handle the object by means of a crane or a grapple, for example, but all actions must be steered by the operator, we call it **advanced mechanized work**. A typical example is a tractor or forwarder equipped with a loader.



Actually, mechanized work is developing more and more towards **automatic work**. We like to subdivide 4 steps of automation:

- i1 information assistance (by sensors)
- i2 control assistance (by electro-hydraulic control, e.g.)
- i3 automation of sub-processes
- i4 driverless operations

In forestry, the cut-to-length harvester is an example of a machine that reaches the level i3 automation of sub-processes. Some prototypes try to operate driverless (i4).

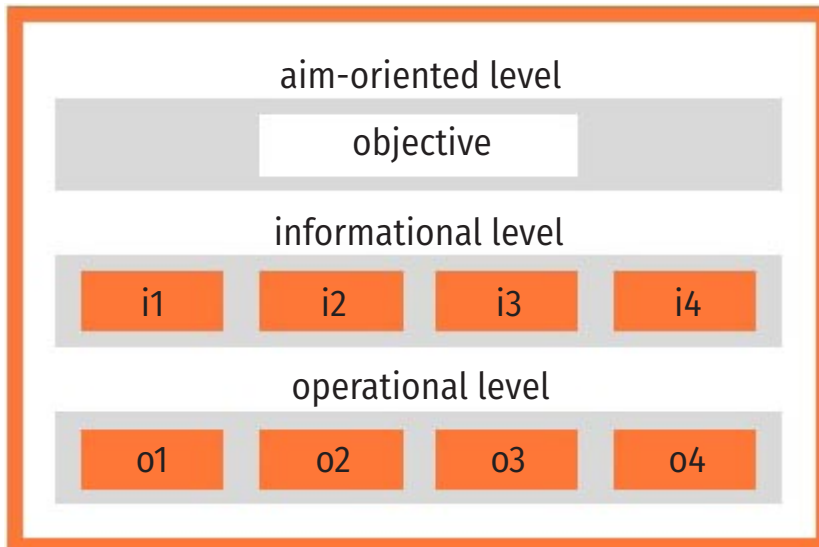

Figure 20: Mechanized work; the part that is taken over by the machine increases, several grades of mechanized work with the end of automatic work can be differentiated white color > performed by human; orange color > performed by a tool or machine

Conclusion: degrees of mechanization

Every working action can be described by the tool or machine that is in use. And consequently, we describe its mechanization with one of the following degrees

- manual work
- motor-manual work
- mechanized work.

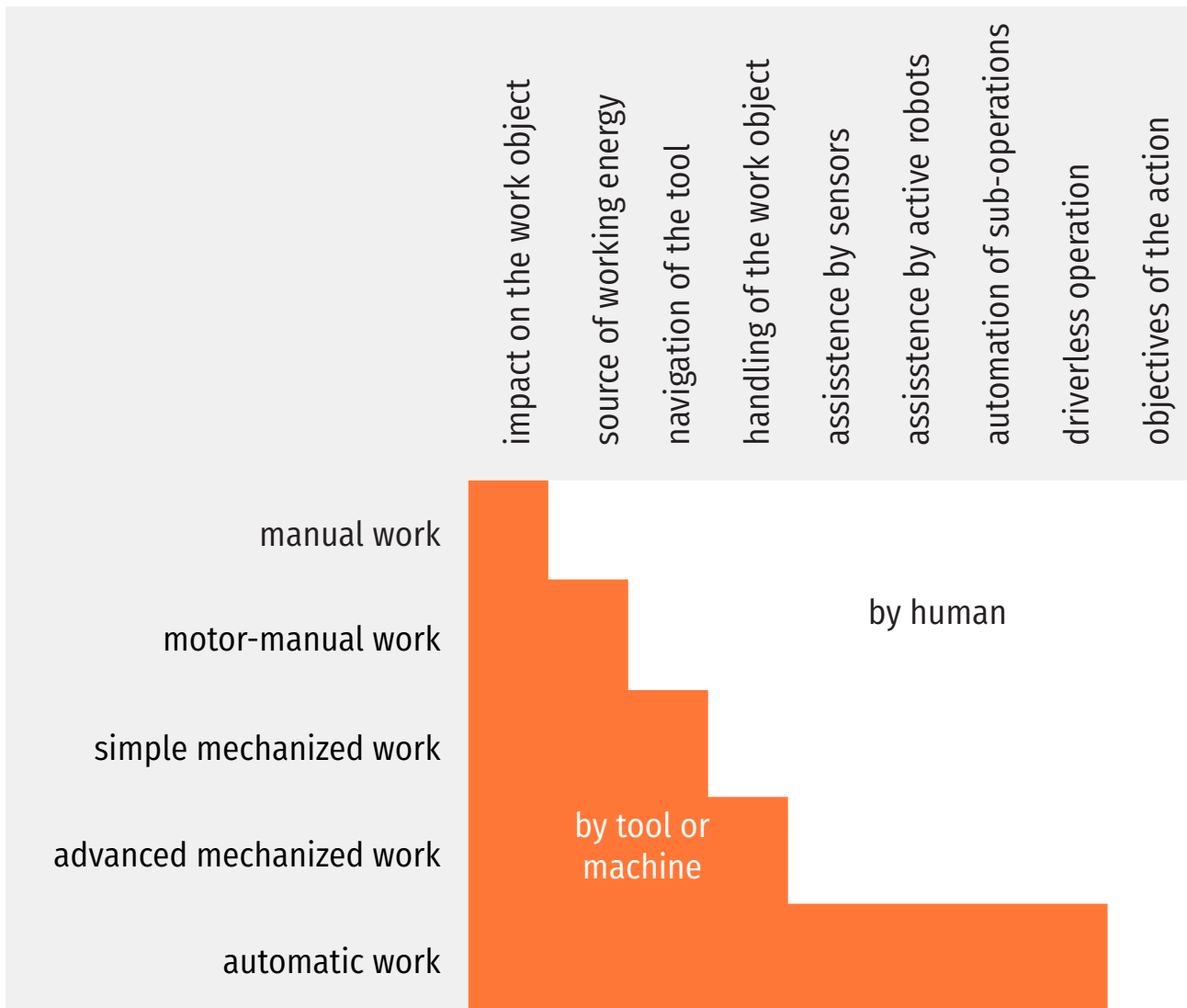

Figure 21: Degree of mechanization of a single working system





B05 Degree of mechanization with composed systems

In most cases, a total harvesting process consists of two sub-processes. In order to describe the mechanization degree of this total process, we look for a way to describe the combination of the degrees of mechanization.

(Fully) manual method: If there is no power equipment in any sub-process, say both sub-processes are done by manual work, the method is a fully manual method. The word “fully” underlines the character of the process, but it can be missing.

(Fully) motor-manual method: If both sub-processes are done by motor-manual work, the total process is a fully motor-manual method (or simpler: motor-manual method).

(Fully) mechanized method: If all sub processes are done with self-propelled machines, the method is a fully mechanized method or easier: mechanized method.

Partly motor-manual method: Very often the degrees of mechanization are different. If one sub-process is done by manual work and the other by motor-manual work, then the method is a partly motor-manual method.

Partly mechanized method: If one sub-process is done by manual or motor-manual work and the other by mechanized work, then the method is a partly mechanized method.







Degree of sub-process 1		Degree of sub-process 2		
				
	manual work	(fully) manual	partly motor-manual	partly mechanized
	motor-manual work	partly motor-manual	(fully) motor-manual	
	mechanized work	partly mechanized		(fully) mechanized

Figure 22: Degree of mechanization of a process that is composed by two sub-processes

Degrees of mechanization with more than two sub-processes

In some cases, there are more than two sub-processes combined. In this case, we first find out the degree of mechanization that is given by the combination of two sub-processes. On the left side of Figure 23, we see the degree of mechanization of these two sub-processes. Next, we add the degree of mechanization of the third sub-process and find the degree of mechanization of the total method.

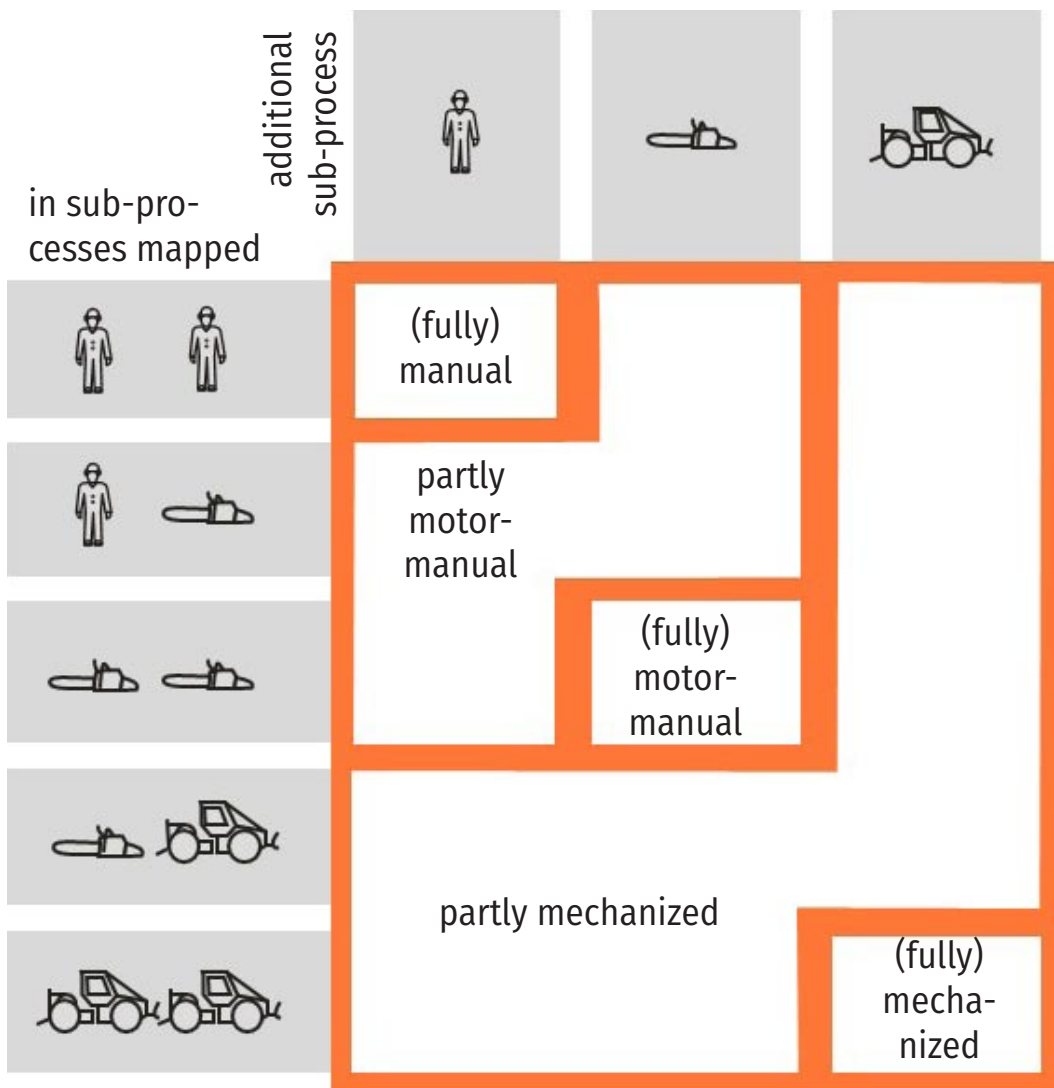

Figure 23: Degree of mechanization of a process with more than two sub-processes

Almost fully mechanized

Sometimes it happens, that the proportions of the sub-processes are not well balanced. This means that two sub-processes are necessary for all cycles, while a third one is only necessary for a subset of working objects. If, for example, the main work is done in a fully mechanized way and only for some cycles a motor-manual work must be included, then we can express this special situation with “almost fully mechanized”.



B06 The functiogram

The functiogram is a tool for visualizing the harvesting method. It is not the only depiction and concentrates on the functional aspect.

On the X-axes we express the location of the action:

- Stand
- Trail (skid road, strip road, corridor)
- Forest road
- Factory

From top to down, we show the steps leading to the object state change:

- Complete tree
- Full tree
- Tree length
- Log
- Chips

From the combination of both, we get a ‘road map’ of different paths, through which we can move from the top left corner (the living whole tree) to the comfortable right end (i. e. the desired product).

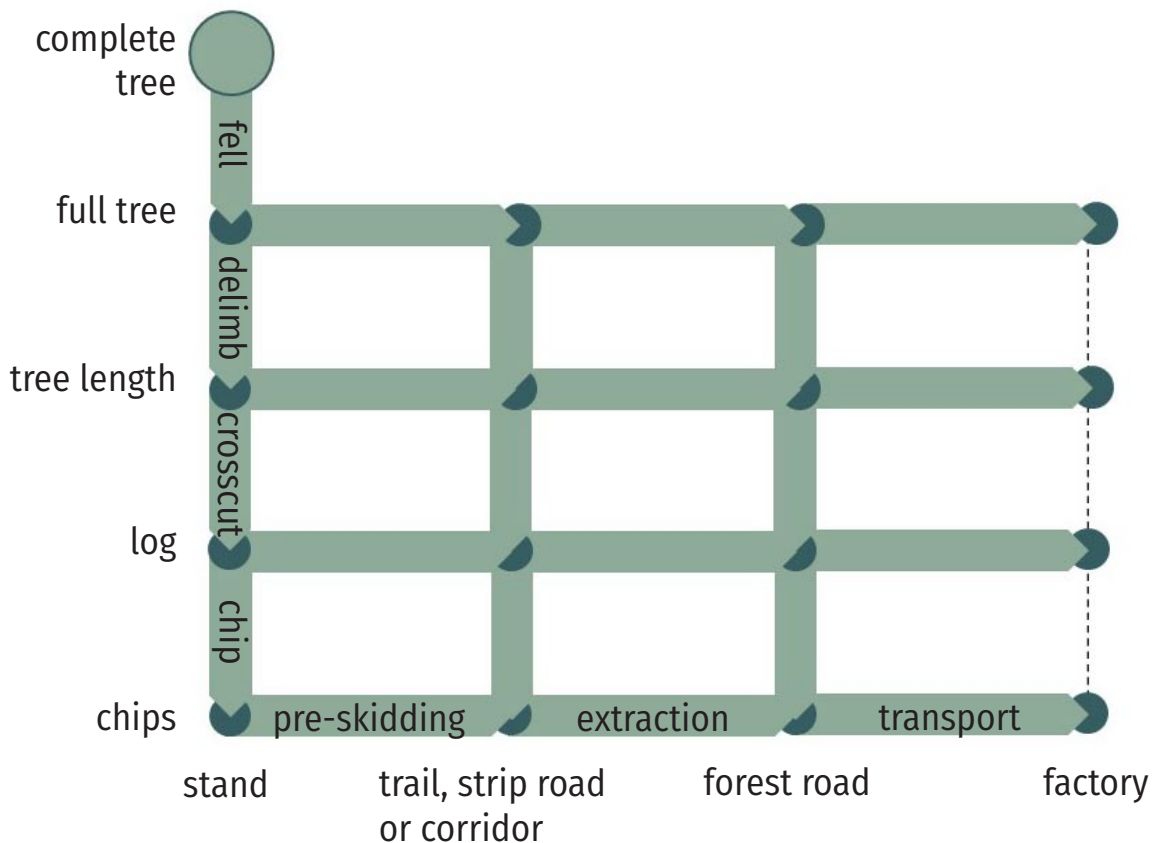

Figure 24: Basic matrix of the functiogram

For example (Figure 24): harvester and forwarder chain

The harvester performs the following tasks:

- fells the tree,
- moves the full tree to the strip road (pre-skidding)
- delimits the tree
- cross-cuts the tree length into logs.

Finally, the logs are stored alongside the trail as a small pile – i. e., a buffer (dark button).

The forwarder:

- loads the logs,
- carries them along the strip road and to the landing at the forest road
- unloads the logs.

Here again a buffer is formed (second dark button).

The truck

- loads the logs
- and delivers them to the user plant.

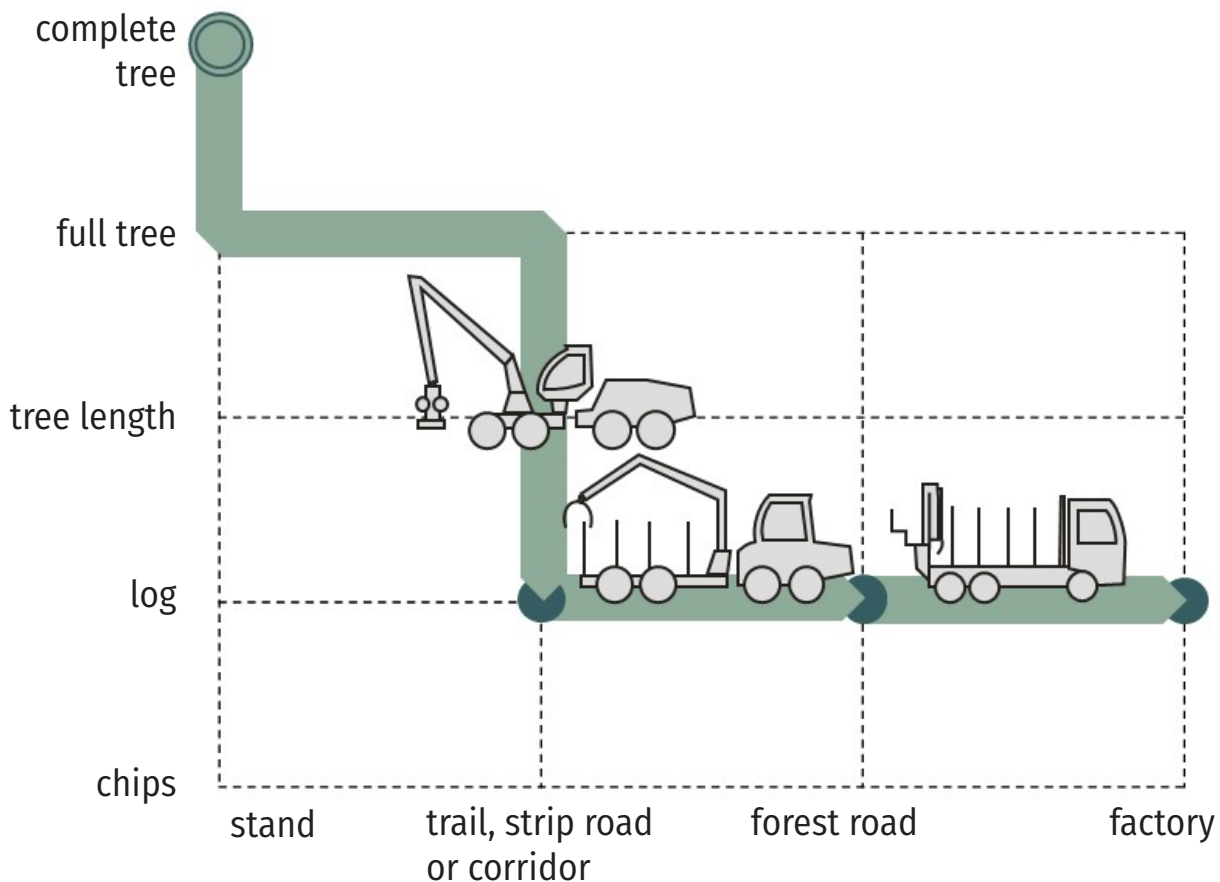

Figure 25: Functiogram of a harvester and forwarder chain (fully mechanized ctl-method)



Functional groups

There are many possible ways to harvest trees. Therefore, people want to categorize the options into meaningful groups. Using the functiogram, we look at the form in which the tree arrives at the forest road

- As a full tree = full tree method
- As a tree length = tree length method
- As a short log = short wood or cut-to-length method
- Or as chips = chip method.

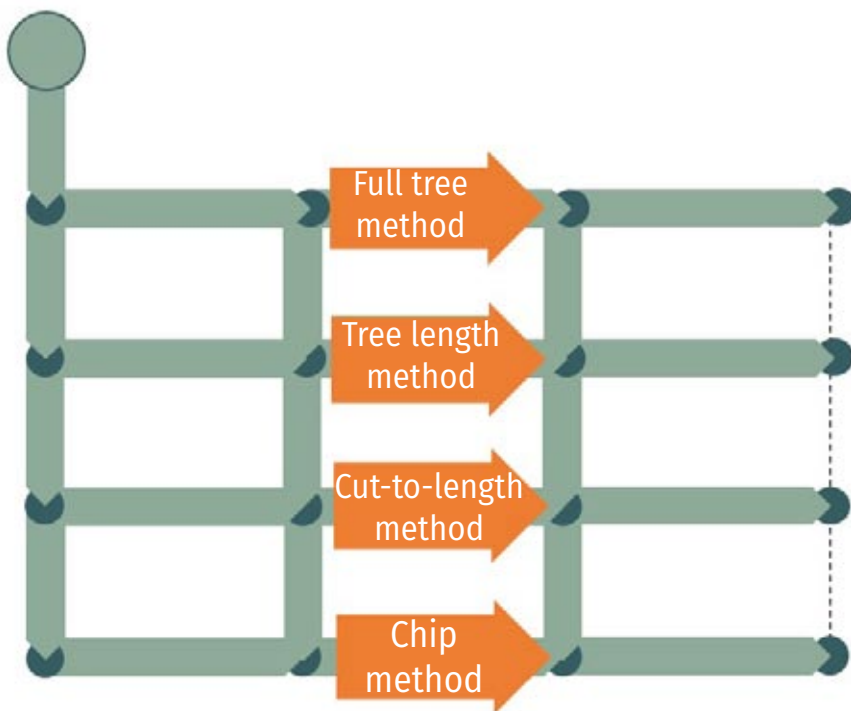

Figure 26: Functional groups of harvesting methods on the basis of the functiogram

Full description of a harvesting chains

In the case of Figure 25, harvester and forwarder follow a cut to length method, because the tree is taken to the forest road in log form.

And since all work is done by these two machines, the degree of mechanization is “mechanized” or “fully mechanized” (see Figure 22).

Now we have the full description:

- The adjective “mechanized” (or “fully mechanized”) describes the structure of the system.
- The subject “cut to length method” describes the functions: what is done inside the forest and how the product arrives at the forest road.



B07 Process chaining

To find an operational process chain, several sub-processes can be assembled into a full chain, when the end of the foregoing sub-process matches the needs of the following sub-process. In the functiogram, such a so-called 'buffer' is symbolized by a dark button.

In real life, when we plan any job, we know where it begins and where it should end. Between these two stages, we have a lot of options to reach the aim. But as soon as we define one specific sub-process, the list of viable sub-processes becomes much shorter.

Thus, the buffers get a central importance and can be defined through their location and state of the product, using a simple two-digit code.

The first digit indicates the location, as follows:

- 1 = in the stand
- 2 = on the trail
- 3 = at the roadside
- 4 = at the plant

The second digit indicates the state of the product, as follows:

- 0 = complete tree
- 1 = full tree
- 2 = tree length
- 3 = short logs
- 4 = chips

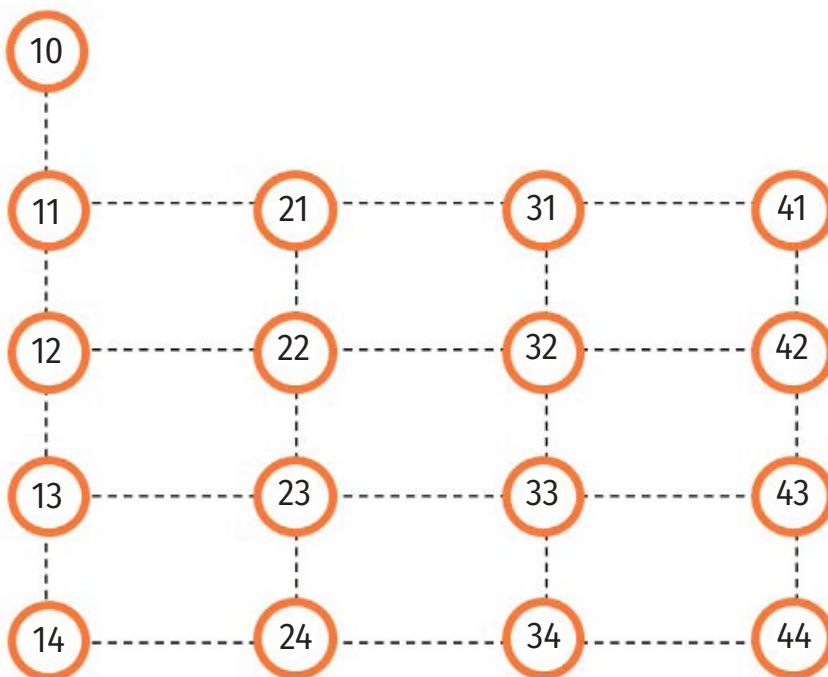

Figure 27: Nomination of the buffers in the functiogram; they are used to define the sub-processes



For example, buffer 23 says that

- short logs (=3)
- are stored on the trail (=2)

Between two buffers, in most cases one can find more than one way to accomplish that goal. Along the chain, various **sub-processes** can be combined. So, there may be only few sub-processes that can be seen often in practice life, but the free combination of them allows a large variety of **total processes** that are well adapted to the local conditions. This is the basic idea of Technodiversity.

In this Technodiversity booklet, more than 30 important sub-processes are described with a profile, beginning with SP- (sub-process). They are identified by the starting buffer and the final buffer and an alphabetic character. For example (Figure 28)

- harvester = SP-10-23
- forwarder = SP-23-33

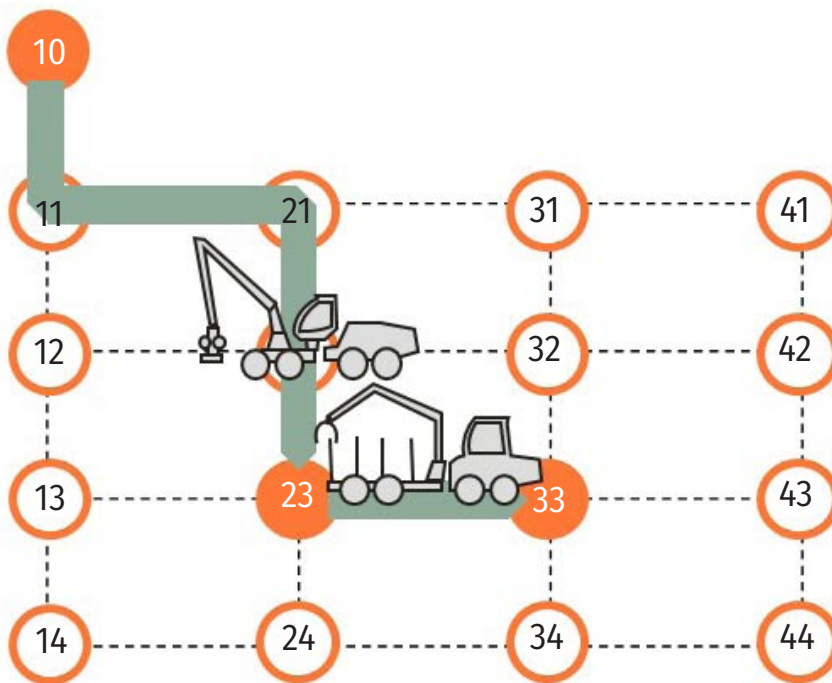

Figure 28: Example for process chaining: “SP-10-23” (= harvester) is combined with “SP-23-33” (= forwarder)



C ECONOMIC SUITABILITY

The chapter C gives hints for the economic assessment under the local conditions. In the three-step-model of decision-making, we enter the second step called “local assessment”.

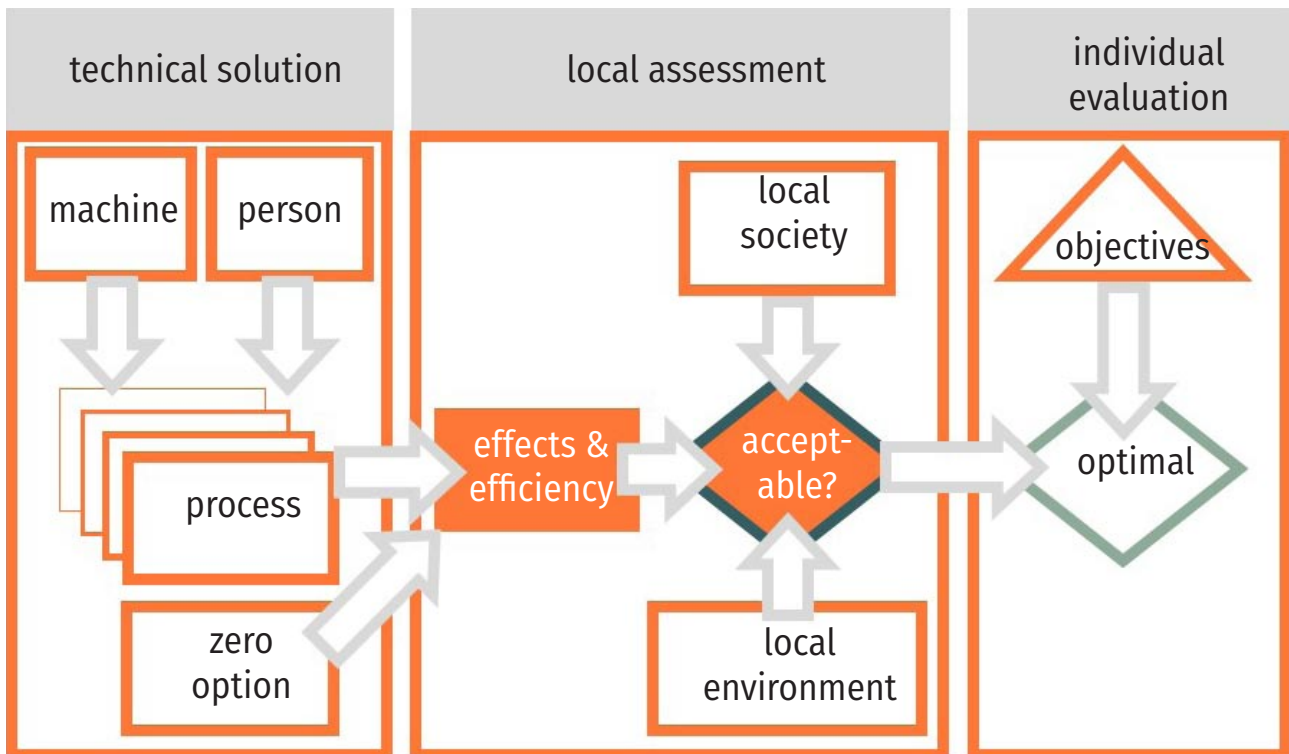

Figure 29: Economic suitability in the three-step-model of decision making





C01 Economic criteria

Optimality is a combination of efficiency and effectiveness:

- With effectiveness we ask whether the objective is fulfilled by the effect of our action. The option that fulfills the objective best is the winner.
- With efficiency we ask, how many resources are consumed by each option. The option that consumes the minimum of resources is the best one.

In the case of economy:

Effectiveness is another word for functionality. In our decision-making model, on the first step we have made a preselection for those harvesting methods that work. But it often happens, that some technical options cover less than 100 % of the working area. Therefore, we sometimes say “**coverage**” to the effectiveness, too.

Furthermore, we must assess efficiency. Efficiency looks for the minimum input, in this case the minimum operation cost. The decision maker must estimate the costs based on very foggy data.

Before the decision of investment, he/she makes a pre-calculation. The data that he/she needs come from post-calculations of comparable systems at the end of their “life“. Very important is also the interim calculation, because it checks, whether the decision was right or wrong. It should be made every year.

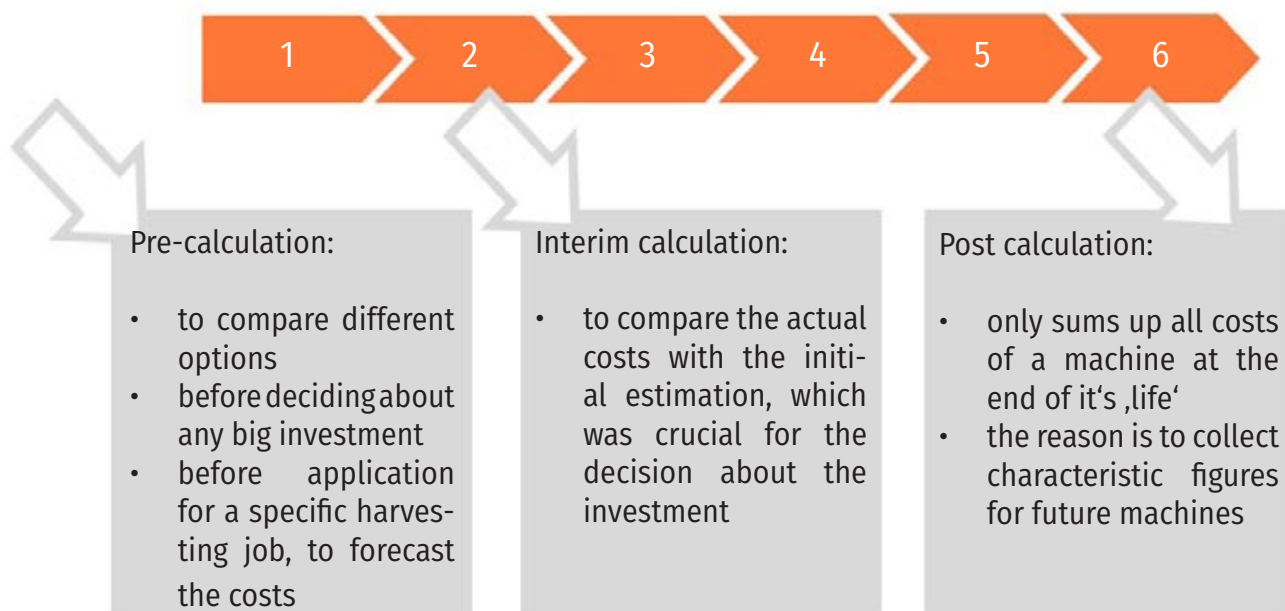

Figure 30: Three sorts of cost calculations and their aims

Tree of calculations

When we sell timber on the market, we receive the price of the logs. But we also invest some money to harvest the trees and transport the logs. So only the difference between price and costs, which is the net income, is available for the company's profit.

As we have seen before, most harvesting processes are composed of two or more sub-processes. The costs of a total process are given by the sum of the costs of its constituent sub-processes.

In that working hour, the system will process a certain number of products. The ratio between number of products and time is called performance or productivity. When we know the productivity, we can match the costs per hour to the production in order to get the costs per unit of a product.

For timber harvesting, we need to divide the costs per hour by the productivity, that is: m^3 per hour. Machines and employees cost money, whether they work or not.

This means that the system will generate a cost even when it is not producing anything. Those additional unproductive times and costs that are necessary for production (maintenance, preparation etc.) must also be accounted for. To do this, we shall add all additional costs and divide them by the total sum of m^3 on that specific working site.

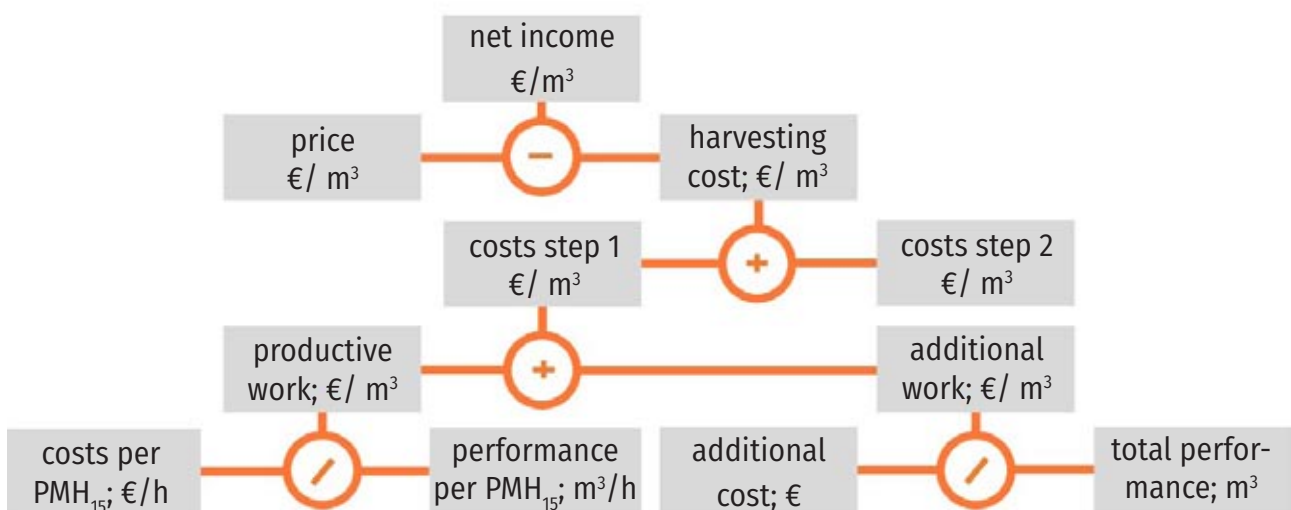

Figure 31: The tree of calculation for a harvesting operation



C02 Machine cost calculation

By machine cost calculation, we try to calculate the costs of a machine system per productive hour. Be aware that this does not represent the system costs. In some countries, there are calculation information available that are filled up with actual values (like oekl.at). If you have it, you can take these values as a good estimation. If not, you must calculate the costs per hour.

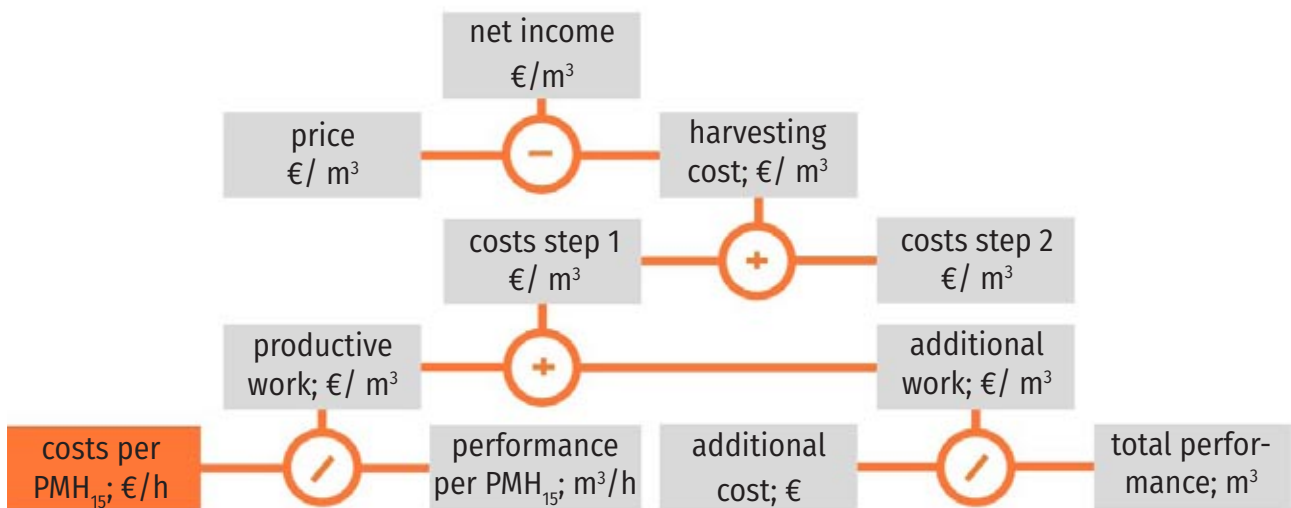

Figure 32: Machine cost calculation is a part of the cost calculation of a harvesting method

The engineering formula: costs per PMH₁₅

Imagine you plan to buy a machine. It is very expensive, so the decision should be made carefully.



Figure 33: Elements of a machine cost calculation

If you intend to get a loan from the bank, you need a plan to pay the money back within a certain time. That means: hour by hour you must put aside a certain sum, which you will transfer to your bank at the end of the month. We call it **depreciation**.

But your bank wants to get more because they help you with the investment and take over the full risk (in case you cannot payback the sum); therefore, they demand for an additional **interest**. This means that at the end of the month you have to transfer to the bank not only part of the sum you borrowed, but also the interest on the remaining sum that is not paid back yet.

Occasionally your machine will suffer some terrible breakdown. If you haven't set aside some money for such occurrence, you will get into big trouble. So, it is wise to set aside a certain sum of money with which you can pay **repairs and maintenance** (R&M) work when they are needed.

Until now, the costs are present regardless of whether the machine runs or not (fixed costs). In addition, when the machine runs, it consumes fuel, oil, lubricants, in some cases electricity... Of course, you should calculate these **variable costs**.

The last position is the cost of the **operator**. Very often, this is only one operator. But there are some working systems in which more than one person are required.

What is best? Should the costs be set rather low or a little bit higher out of caution? If you set them too low, you risk that you won't have enough money when needed. And when you calculate your working price on the base of this calculation, you will not get enough for your service, and you will have to pay a part of your job by your own – which is not a good business model.

In contrast, if you calculate too high, you are on the safer side. But the downside is that your service will be too expensive, and you may not be competitive.

So, it is wise to calculate costs as accurate as possible.

Depreciation

The lifetime of any tool or machine is limited. There are several reasons for decay:

- Technical decay (obsolescence) depends on technical progress: as new and better machines appear, your old machine may be no longer competitive.
- Technical aging (wear) happens when parts of the machine become thin, stiff, inflexible and break, i.e.
- In some situations, we have only limited use of a machine, afterwards we will not need them any longer.
- Or the machine suffers from a “fashion change”, when your technology will become unfashionable, and nobody will be interested in this technology any longer.

Depreciation is the response to the progressive loss of value of your machine. During this time, we must pay back the initial investment.

If we did not borrow the money from the bank because we have taken it from the “investment pool” of our company, then we have only changed money into a machine with the same value. So, when the value of the machine decreases, we must pay back into this pool in order to stay as “rich” as before.



A third argument for depreciation deals with taxes: Since the taxes are based on the net yield, we should not forget the hidden costs by the daily devaluation of our equipment.

How do we calculate depreciation?

- First, we decide how many years the machine will be used.
- Then we ask, whether it will be possible to sell the old machine at the end of the utilization time. But we have to be careful here! Normally there is some residual value, but we may want to assume that it is 0 and use it as a silent reserve to compensate the higher price for a new machine – due to inflation and technical development.
- The annual depreciation now is calculated as the initial investment minus the assumed residual value divided by the number of years.

$$\text{Depreciation} = \frac{c}{d}$$

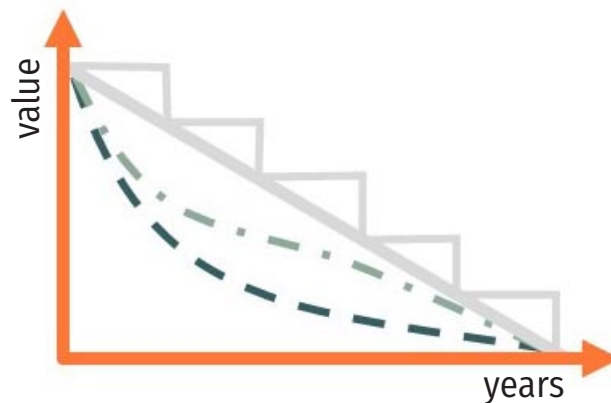

Figure 34: Calculation of the depreciation (c = price of the machine, d = years of utilization)

This is called linear depreciation. In fact, real devaluation is not linear (here implied with different dotted green lines) but in practical term a linear solution is good enough and it is easier to calculate.

Interest costs

Normally, the interest is indicated as a percentage of the borrowed sum per year. In reality, it is calculated monthly on the basis of the actual residual debt. So, it reduces from month to month. In the last month it is nearly zero. Taken as the grand average, interest is calculated over half of the borrowed sum.

Thus, we can calculate the interest cost with

- the price of the initial investment
- divided by 2 (to reach the average)
- times the interest rate in percent.

Do we need to calculate interest costs even when we take the money from our own investment pool? Yes we should, because if you want to buy anything else later on and the investment pool is empty due to your earlier investment in the machine, you must borrow the money for the other investment. This is the reason why we calculate the interest costs even when we don't borrow money from the bank.

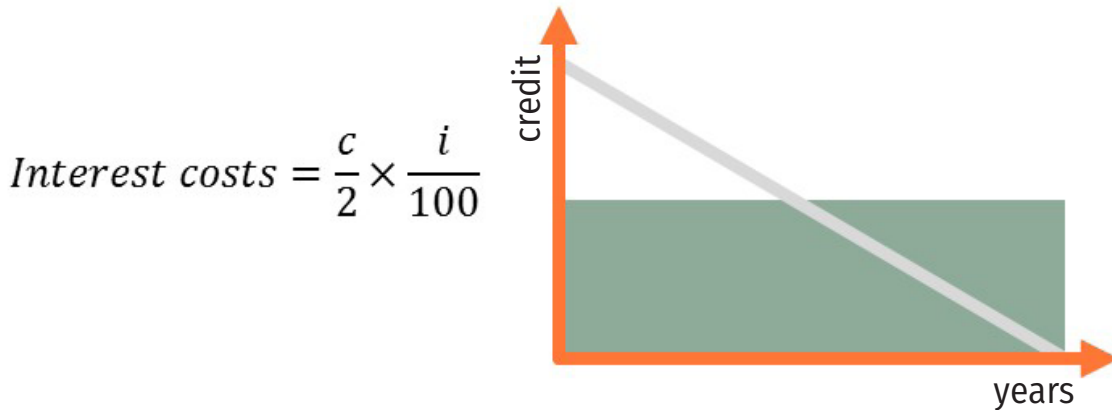

Figure 35: Calculation of the Interest costs (c = price of the machine, i = interest in %)

Repair and maintenance costs

Saving money in anticipation for breakdowns and regular planned maintenance has two effects: Having money available when maintenance is needed and to share those costs that occur irregularly day by day with all customers.

From other machines, we can get a feeling of how high the R&M costs would be. As a general rule of thumb based on experience, a forwarder needs the same sum for repairs and maintenance over its whole service life span as the initial price of the machine. A tractor takes a bit less, a harvester a bit more. This relationship can be expressed as a factor r for repairs.

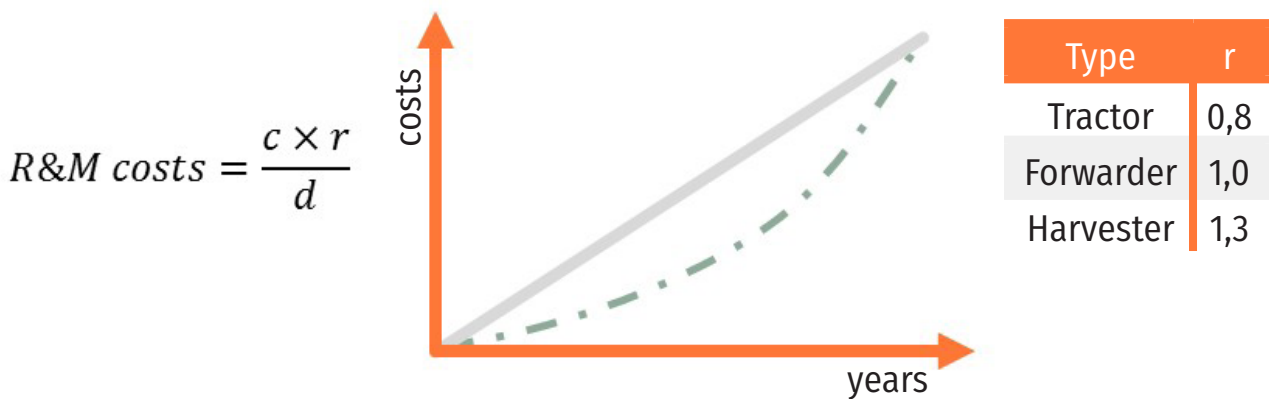

Figure 36: Calculation of repair and maintenance costs (c = price of the machine, d = years, r = factor R&M)



Now it's easy to calculate the costs of repair and maintenance:

- Take the price of initial investment
- multiply it with factor r
- and divide it by the number of years that you expect the machine to run.

However, the trend is not linear. Normally, a machine will have very low R&M costs in the first years, then those costs will increase as the effect of wear develops. Therefore, this calculation accounts for the average costs per year over the whole machine lifetime.

Variable costs

When the machine works, it consumes energy in the form of fuel or electricity, plus other consumables like hydraulic oil, lubricants, and so on. It is not too difficult to estimate these costs per hour(!). With fuel, we multiply consumption (liters per hour) with the price per liter, for example.

But this needs time and depends on the daily cost level. Since here we look for a general approximation, one can also take the sum of fixed costs and multiply it with an appropriate factor like 1.1...

Machine costs per hour

system costs =

Now, we have the fixed and variable costs of the machine per year. But we need the costs per hour. Apparently, that is very simple: we only need to divide the costs per year by the productive hours „ m “ per year.

But how many hours should we use? This varies very much from company to company and from one machine type to the other. Here are some hints:

- It is very difficult to use a machine more than 2000 hours per year.
- When the same operator is driving the machine all over the year (= no shift system), annual usage decreases to 1600 to 1800 hours.
- If the machine is only used seasonally, then annual utilization goes down to 1000 hours or less.

Labor costs

Finally, we must add the labor costs. Here we should be careful:

- If the operator only works with that machine, we can take the total costs of this worker (including insurance etc.) over the year and divide them by the same time of productive utilization “m” as we have for the machine.
- However, a driver or worker often operates two or more machines, in which case it is easiest to calculate his/her costs per hour and then compute all the machine cost calculation on an hourly basis.

Labor costs have two main components:

- w = gross wage
- s = social costs, like insurance, holidays, traveling expenses etc. They are normally indicated as percentage of the gross wage.

The percentage of social costs is highly variable from Country to Country. In Germany it depends mainly on the company:

in private forest companies it is about 80 to 110 %

in public forest administrations it often reaches 130 %.

$$\text{system costs} = \frac{\left(\frac{c}{d} + \frac{c}{2} * \frac{i}{100} + \frac{c}{d} * r\right) * (1 + v)}{m} + \frac{w(1 + \frac{s}{100})}{p}$$

Figure 37: Engineering Formula





C03 Productivity

To get the cost per unit, the costs per hour must be divided by the number of produced units.

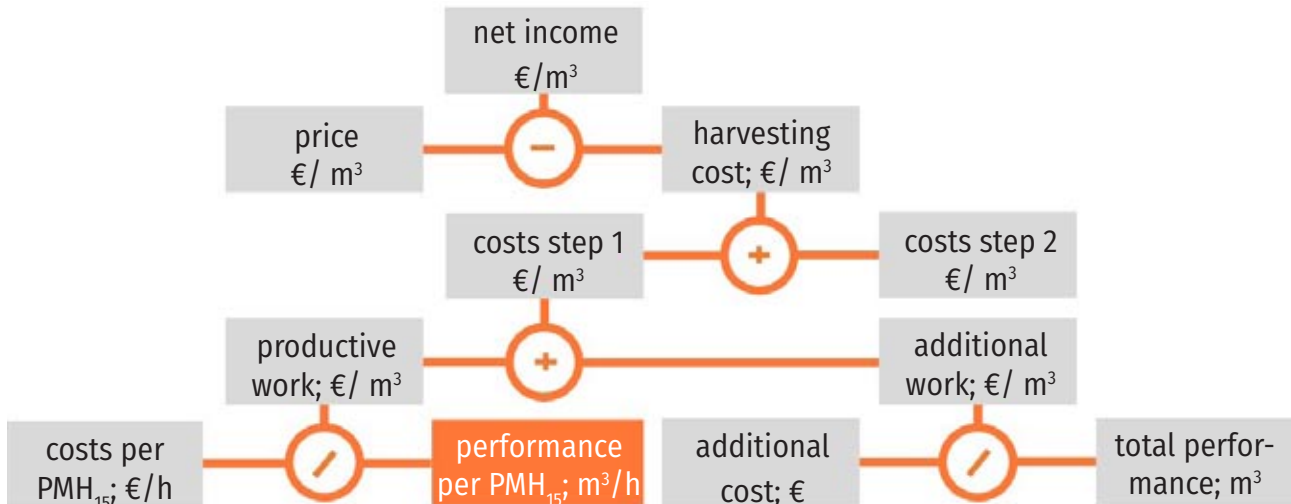

Figure 38: Estimation of the productivity as a part of the tree of calculations

The principle of tree volume: individual curves

When you read any publication about a working system, performance is normally represented by a typical curve (Figure 39, green line):

- It is low for smaller work objects (in our case: trees)
- It increases with the work object size according to a non-linear degressive trend.

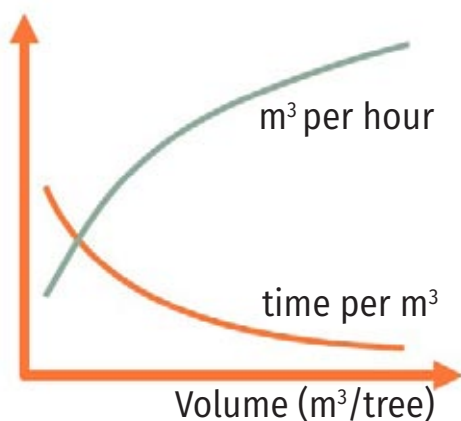

Figure 39: Typical curves with wood harvesting, called “principle of tree volume”

Some graphs also report time consumption in minutes per cubic meter (orange line). Again, we recognize a typical curve:

- Time per cubic meter is higher for small trees compared with big ones
- The trend is degressive.

This system behavior is known as the principle of tree volume.

Science has shown that the **time consumption per tree** depends on its volume according to a typical relationship:

- The bigger the tree, the longer the time needed
- The data cloud can be well represented by a linear regression
- The regression line crosses the y-axis above the origin.

Of course, in scientific case studies, different curve types will offer a better fit. But the linear function is fairly good as well because it gives us the chance to get an overall estimation of the performance. This general assumption makes it possible to forecast the system performance even with very few data points. Provided that we can accept the linear approximation, we can describe the relationship between time per tree and tree size with the equation below:

$$t_i = b_0 + b_1 * v_i$$

The time t_i is composed of two summands:

- b_0 is the fixed time required for processing a single tree that is not dependent on its size. It is typically the time to walk to the tree, clean the area around it etc.
- b_1 is the variable time required for processing a single tree that is dependent on its size. b_1 indicates the time consumption at a tree that has exactly the volume of one cubic meter. If the tree is smaller, let's say only 0.5 m^3 , then the product of b_1 times its volume v_i is also 0.5 compared with one m^3 .

Normally we sell cubic meters, not individual trees. So, we need to know the **time** $t_{i,m3}$ **per cubic meter**. Given our curve t_i , we can calculate

$$t_{i,m3} = \frac{t_i}{v_i}$$

This curve $t_{i,m3}$ includes our two independent variables b_0 and b_1 with the consequence that it looks different for each working system.

Now, dividing 60 min/h by the time consumption $t_{i,m3}$ we get the **performance** in m^3/h .

$$p_i = \frac{60}{t_{i,m3}} = \frac{60 * v_i}{b_0 + b_1 * v_i}$$

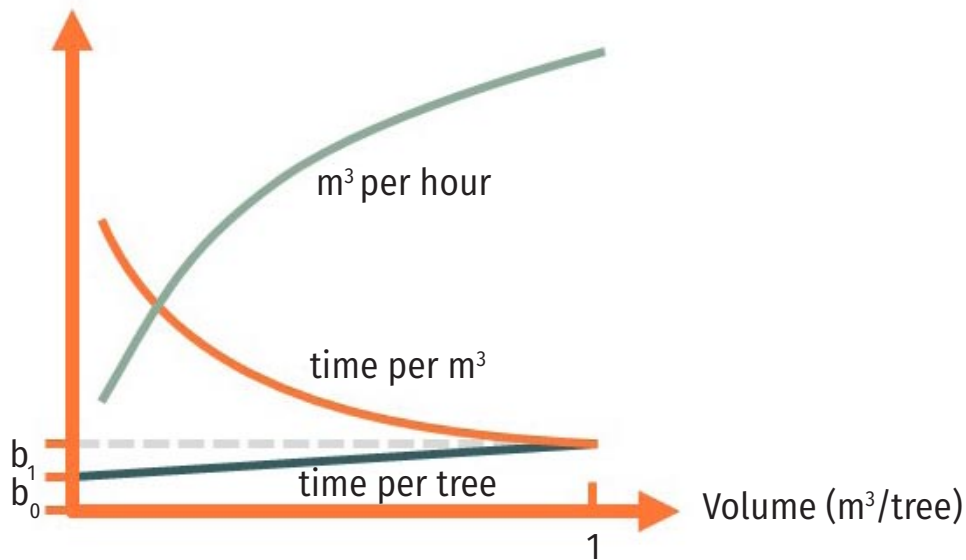

Figure 40: Relationships between time per tree, time per cubic meter and cubic meter per hour

As a summary:

- Using this way, we get to the original source of time consumption.
- Given the assumption, that the relationship between time consumption per tree and tree size can be represented by a linear regression with two parameters b_0 and b_1 , we can cover the whole behavior of the system with two parameters.
- To find those parameters, very few time measurements are enough.
- We can also modify the two parameters of the regression formula for rough forecast purposes:
 - When we see, that in our case the preparation time b_0 per tree is higher than normal (because of thornbushes, slippery ground etc.), we can “correct” this parameter with a better estimate.
 - When we know that our operator is quicker than an average operator, we may adapt the parameter b_1 to his performance level.



C04 Additional costs

Very often it happens that a worker is working hard, but he does not produce any single product. For example, he plans the operation, prepares the worksite etc.

These costs must be summed up, divided by the total sum of units to which it related, and finally added to the costs per unit.

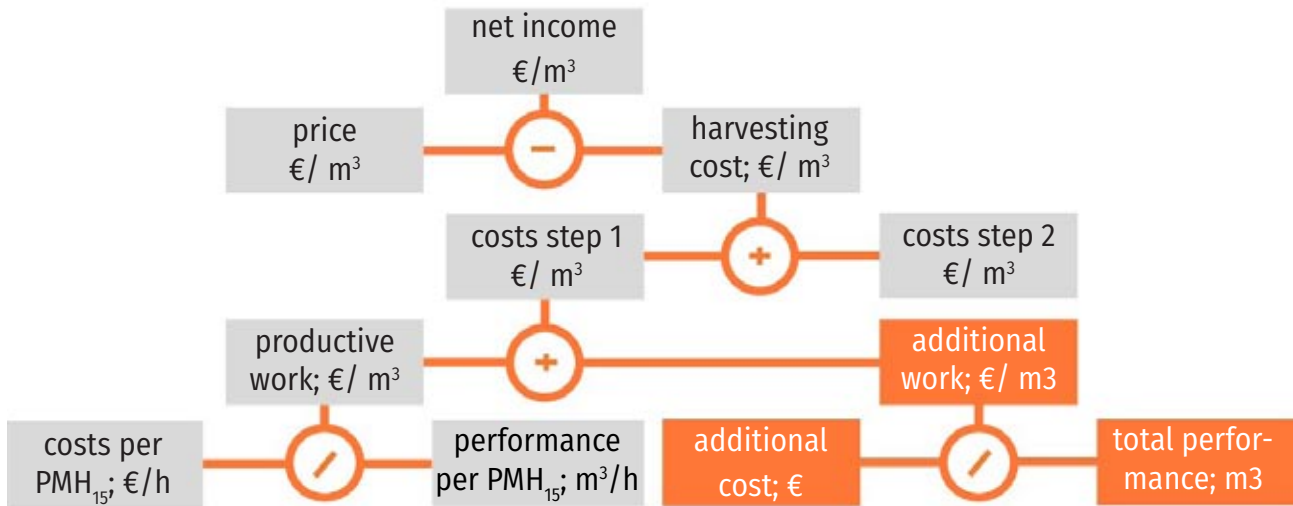

Figure 41: Additional, unproductive costs must not be forgotten while calculating the system costs





C05 Total system cost, exceptions

Combined systems

As we know, most harvesting systems are composed by two sub-systems, like harvester and forwarder. To calculate the system costs, we must only add the results of the machine cost calculations of the sub-systems.

This seems to be simple, almost trivial. But be careful! There are some exceptions.

- When the sub-systems are related to each other in a way that they have to wait for the other one, then the sub-system with the slowest performance defines the velocity and therefore the productivity of the total system.
- When two functions are combined in one machine (like with a harwarder), then only one function can be active, while the other function must wait. Also during the waiting period, the fixed costs must be paid.

Calculation of a written-off machine

Old machines have a different cost structure:

- The value of the machine goes down, but the depreciation jumps under the value when the loaned money is paid back.
- The interest is low.
- The repair costs increase, but can be held down for a longer time because the value of the machine is low
- so, the total costs are low and the force to use the machine decreases.

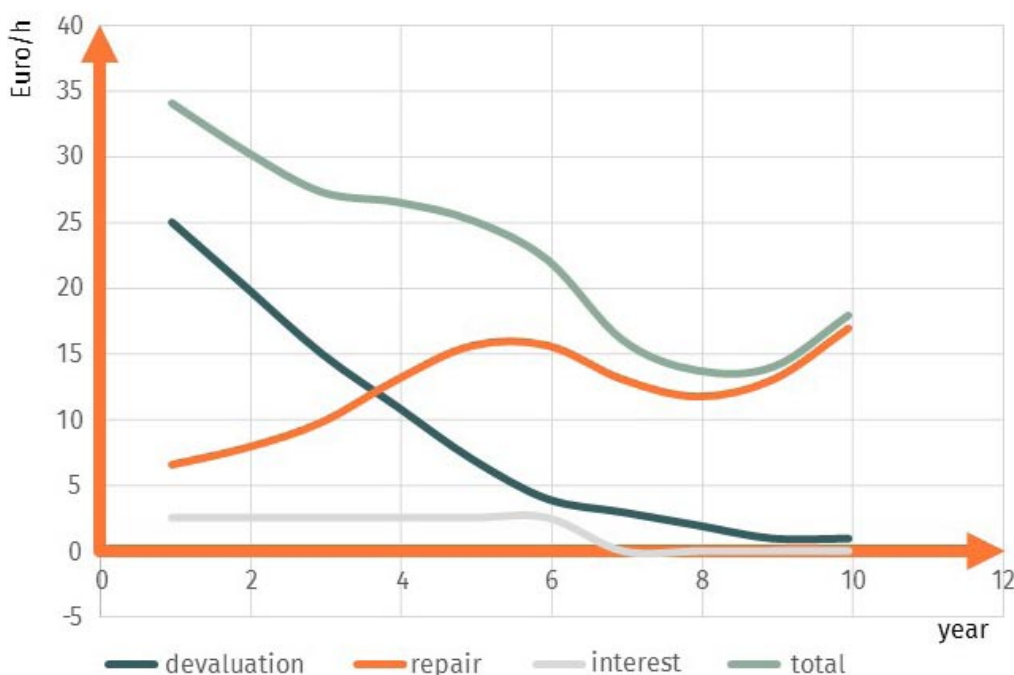

Figure 42: Typical cost structure of a written-off machine

New machine: For a company that is working professionally under a high market pressure, the risk to interrupt the work due to an old machine breaking down is too high. The company may decide to work with new machines only for a short period that may match the depreciation period. Then it will sell the machine on the second-hand market.

Written-off machine: The company that buys this machine pays a low price. Depreciation and interest are low. While the costs for personal, fuel and lubricants may be more or less the same, the costs for repairs and maintenance can be doubled until the total cost is equal to that of a new machine.

This is the reason, why machines often find a second life in smaller companies with lower work performance, where the owners repair their machines themselves.

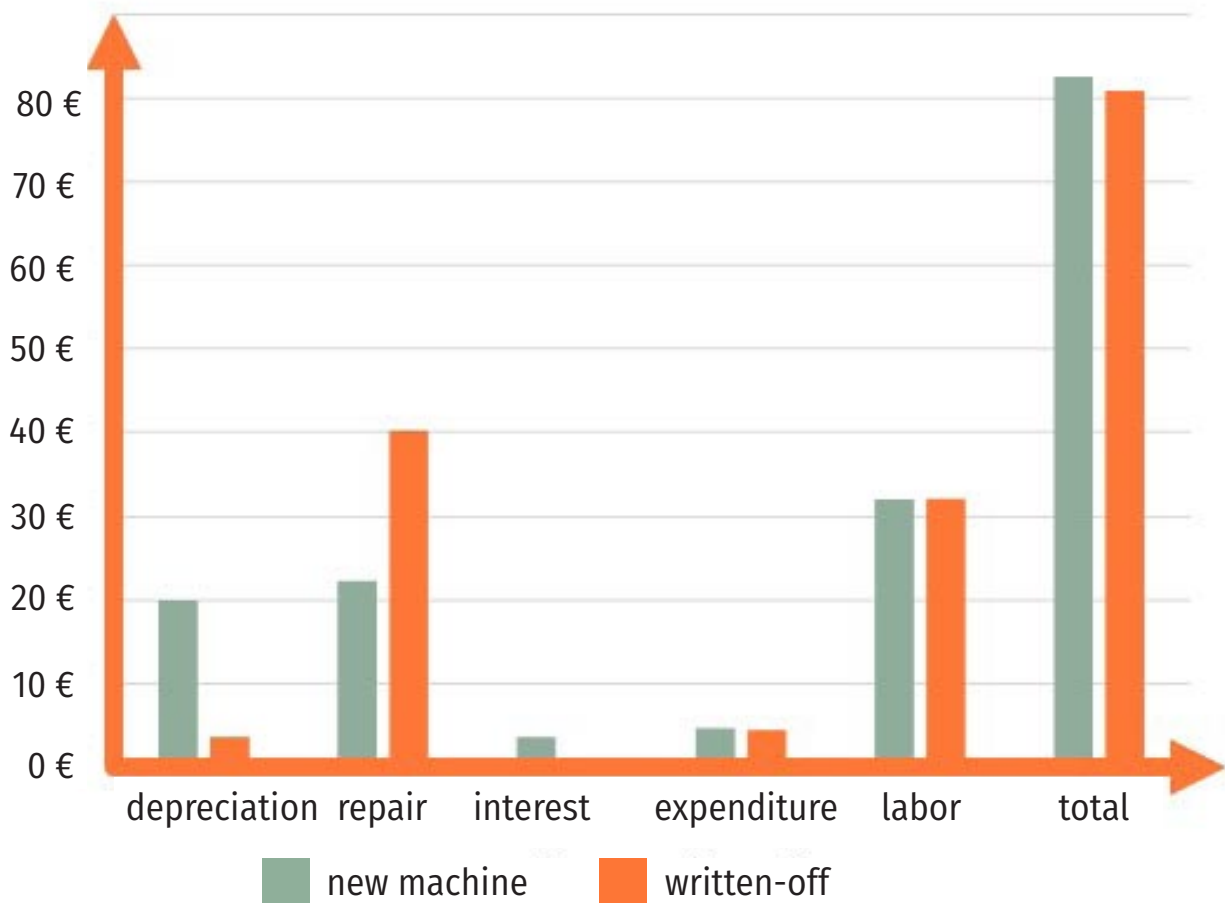

Figure 43: Cost structure of a new machine and a written-off machine (examples)





D ECOLOGICAL SUITABILITY

Work in the forest always leaves traces and often causes damage. But must we accept the damage?

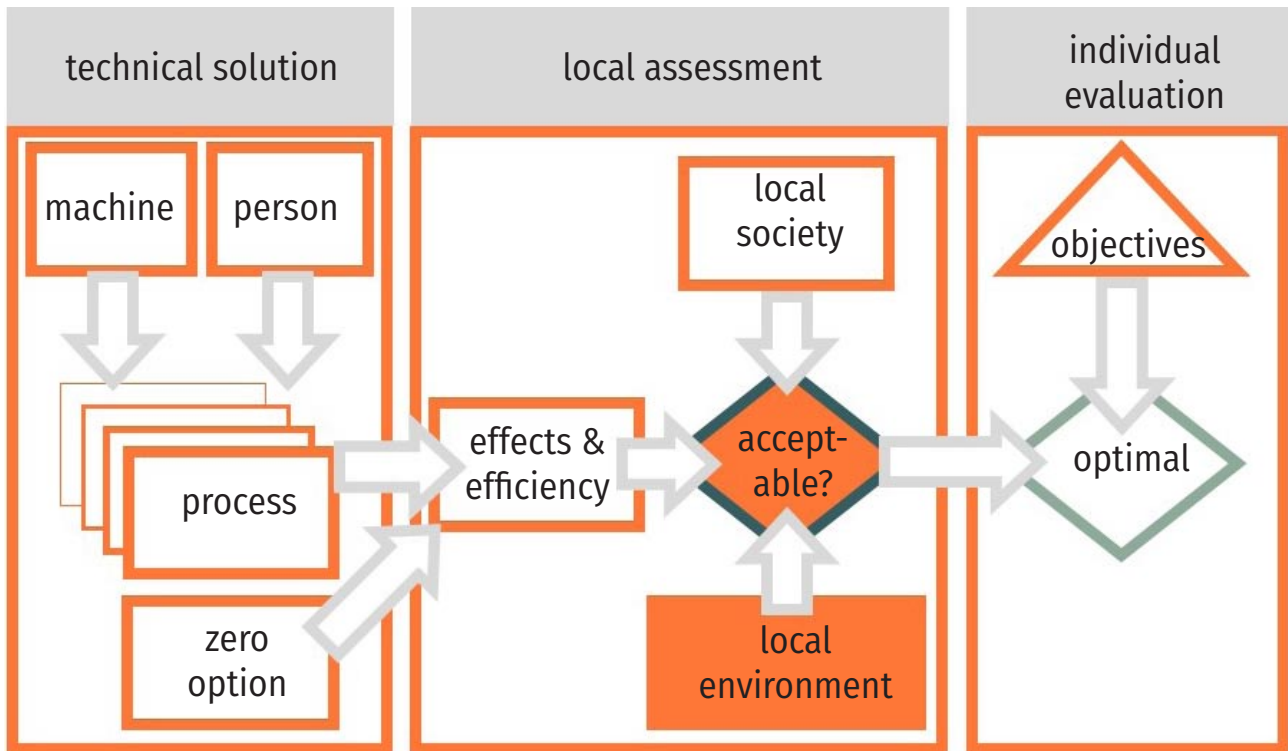

Figure 44: Ecological suitability in the three-step-model of decision making

D01 Risks, side-effects, and damage

Besides the intended effects, there are also non-intended effects (side-effects) and risks.

Side-effects

They happen, whether you like it or not. Normally you don't like them, because those that you become most aware of are those that hurt you, not the indifferent or nice ones.

Your task is to find a way to keep those undesirable side-effects within acceptable limits. To that end, you need to improve your system or system selection.

Risks

Contrary to side effects, risks may happen but are not inevitable.

If they happen, they often cause heavy damage. Now you should estimate the odds that this damage will occur. The risk can be calculated by the damage times the estimated likelihood.

Not every change is a damage

Changes are normal in nature. That is essential to evolution. Most changes happen very slowly. Even when they have undesirable effect, we don't call them "damages". A damage is caused by a suddenly occurring, singular incident.

Is every change important? If not, let us forget it. Whether any change is a damage depends on the subjective view of a human being. A damage only happens to things that have a certain value to us. This may not be expressed in terms of money: it can also be ecological value, social value, or emotional value... the fundamental thing is that value is being lost.

So, we shall call "damage" only those changes that have undesirable consequences.

And will this undesirable change last for a long time? Or is the system able to reverse it in a reasonable time? But what is a reasonable time? This depends on the situation. In forestry, a practical approach would be to define reasonable time as the time span between two interventions – or "return time", like 10 years. If recovery needs longer than that we may consider the damage as permanent.



Responsibility: In forestry, very often people have the tendency to blame the machines if something goes wrong. But a lot of negative changes have their root cause in a wrong decision. In such case, the machine is not to blame, but the manager who has taken the decision. But on the other hand, when the machine has caused the damage, we should address it clearly to avoid the same incident in the future.

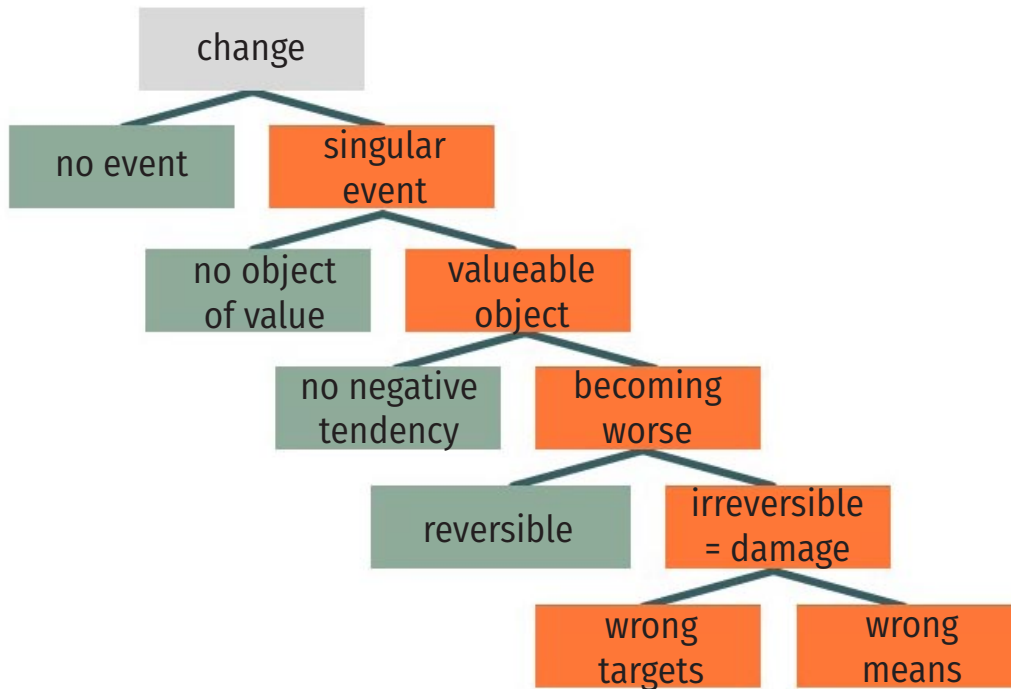

Figure 45: Change or damage? A decision making tree

Classically, harvesting may cause two sorts of damage to forest stands: felling damage and skidding damage.

Felling damage: motor-manual case

With motor-manual felling, the tree falls down forming a quadrant. The axis of this movement originates at the aptly called “hinge”. As it falls, the tree develops a high dynamic force. Any obstacle in its way is in serious danger. If another tree is hit, it will be broken or wounded.

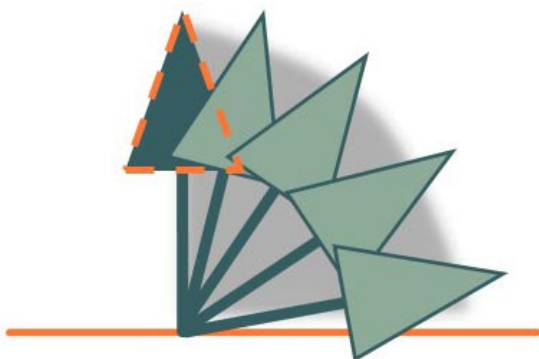

Figure 46: Area in danger while motor-manual felling

Felling damage: mechanized case

With mechanized felling – using a feller or a harvester – , the tree is cut from its root, lifted a little bit and pulled towards the machine position. As a result, the wide tree crown falls mostly in the void left by the cut tree – and where now there is little that could be damaged.

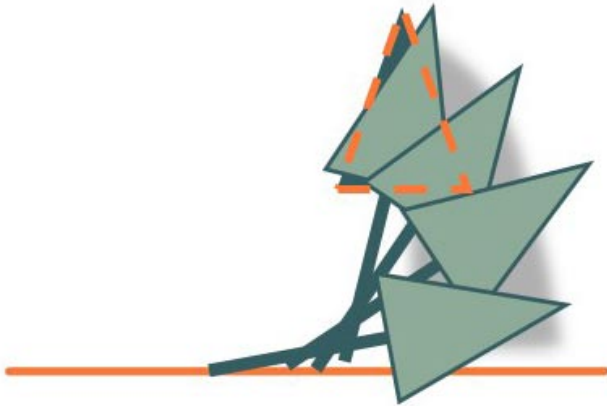

Figure 47: Area in danger with machine felling

Experience shows that by this procedure the risk of inflicting felling damage to the remaining stand has been reduced to nearly zero.

The machine is often strong enough that it can lift the tree upright and move it out of the stand, so that it can be laid down where there is no risk of damaging anything. This procedure is applied when the driver wants to spare clumps of regeneration developing under the cut tree.

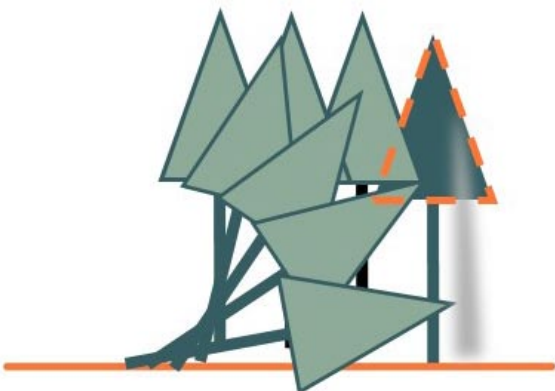

Figure 48: Area in danger with strong felling machines



Skidding damage by the machine itself

Animals seldom drive into trees, because they do not like to be hurt; in contrast, machines can drive into a tree – even if they get damaged themselves.

This happens often enough, when the situation is confusing like in dense stands. Here it is important that the moving pattern of the machine is kept simple. Curves can be tricky, because the rear axle has a shorter turning radius than the front axle – that is called **Ackerman steering**. Conventional machines like farm tractors have Ackerman steering.

Dedicated forestry machines often have an **articulated frame**, where the two half-frames are connected by a central hinge. In that case, the rear wheels follow exactly the same track as the front wheels. The risk to damage trees is much lower.

Less tree bumps with bogie axles

The forest floor is covered with many obstacles: small and large. When one of the tractor wheels rides over a stump, the whole frame is tilted to the side. The danger to hit a tree is high. The reason is that the chassis is lifted on one side with the angle α and pushes the frame with the angle α , too.

If the machine is fitted with bogies, one wheel will ride over the stump, while the other will remain on the forest floor. So, the angle, by which the chassis is lifted, is only $\alpha/2$. The deflection of the frame is only $\alpha/2$, too.

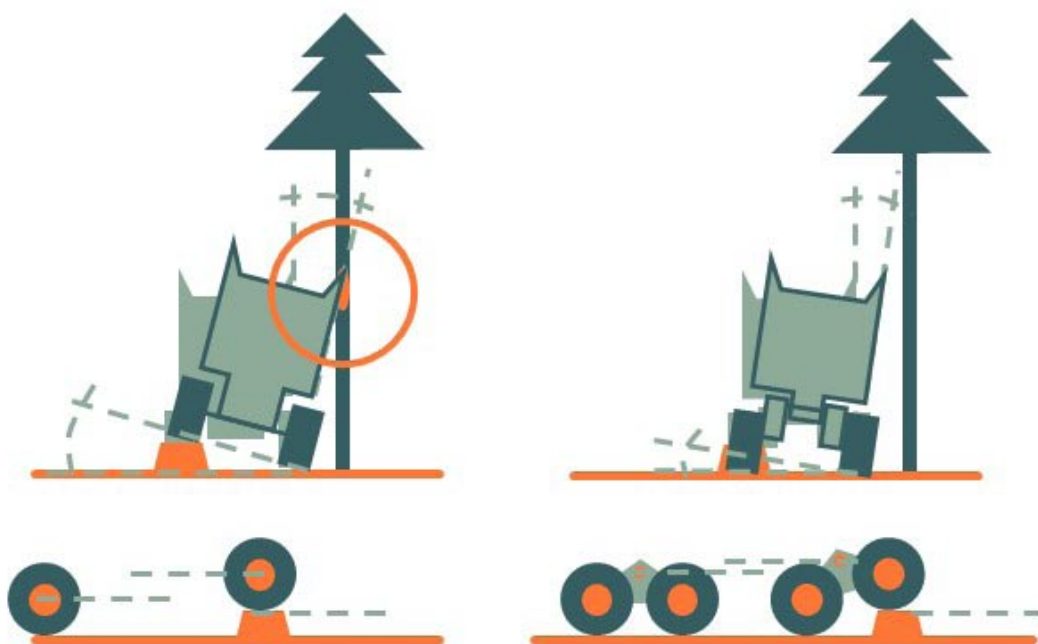

Figure 49: Effect of bogie-axles

Damage depending on the log length

Damage to the stand can be caused by long logs, too. The area of the danger zone depends on the length of the log and the angle α between log axis and strip road.

The formula just below says that log length has the most important influence on the danger zone.

$$A = 0,8 * L^2 * \frac{\alpha}{90}$$

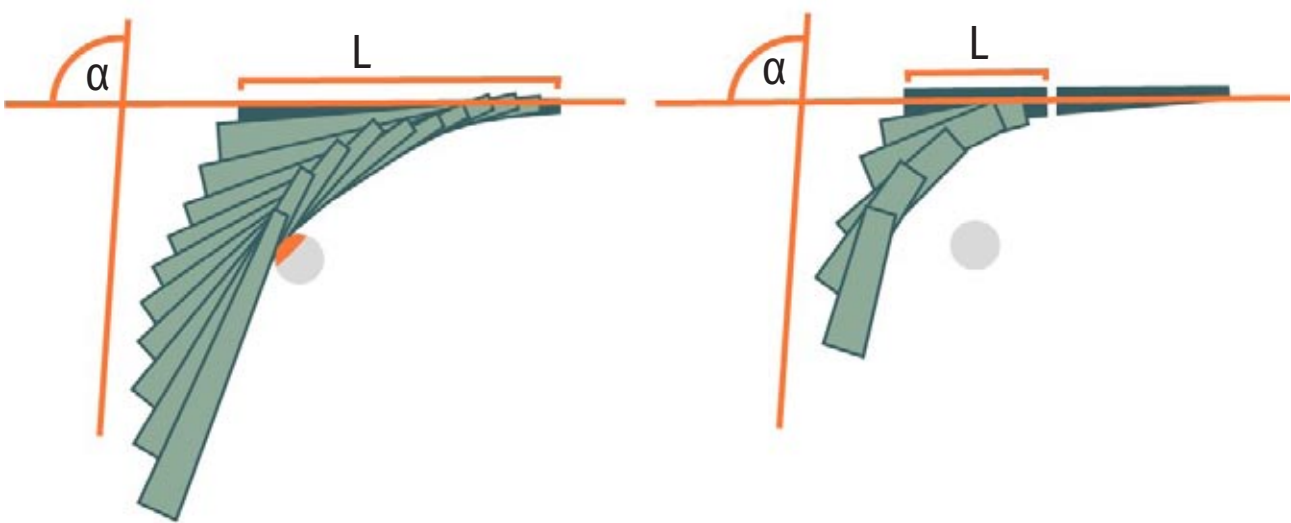

Figure 50: Extraction of tree lengths and short logs, risks to damage the remaining trees





D02 Damage to forest soils

Tri-state model of soils

Let us imagine three states of soils.

- Untouched forest soil: biologically healthy and productive
- Trafficable trail: compacted by former traffic and strong enough for future traffic
- Destroyed trail: impacted by former traffic in a way that is no longer usable.

Some geo-mechanical basics (stable conditions)

When a vehicle gets in contact with the forest floor, its weight bears on the ground. The weight bears on the solid phase like stones, clay and roots. Together with the reaction of the ground, they form a power triangle: When the triangle is closed, the soil is stable, and the wheel stands on it.

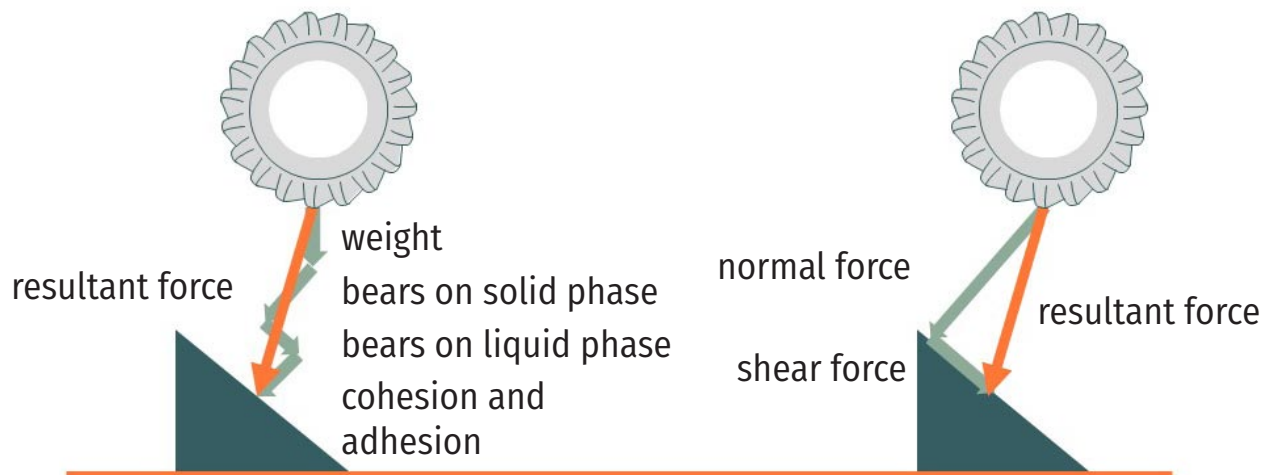

Figure 51: Forces caused by a wheel on dry capable soil

But the forces are transmitted to the soil pores filled with water, too. Since liquids cannot be compressed, they transfer the load in all directions.

Directly on the surface two additional effects occur: The cohesion describes the binding forces of a body, for example when the wheel is caught by a thorn vine. The adhesion depends on the electromagnetic coherence between two units, here between wheel and soil surface (but this force is very weak).

All these forces together form the resultant force. The resultant force is derived from two components:

- the normal force, which works perpendicular to the contact surface and
- the shear force, which works parallel to the surface.

Some geo-mechanical basics (labile conditions)

Here we have another example, where the load on the solid phase is low, but on the liquid phase it is very high. The shear force is so high that the resultant force overrides the reaction force of the soil. Thus, the power triangle is not closed. The soil will be compacted. This compaction will make the soil stronger, and the reaction force increases. When the reaction force is equal to the resultant force, the compaction stops.

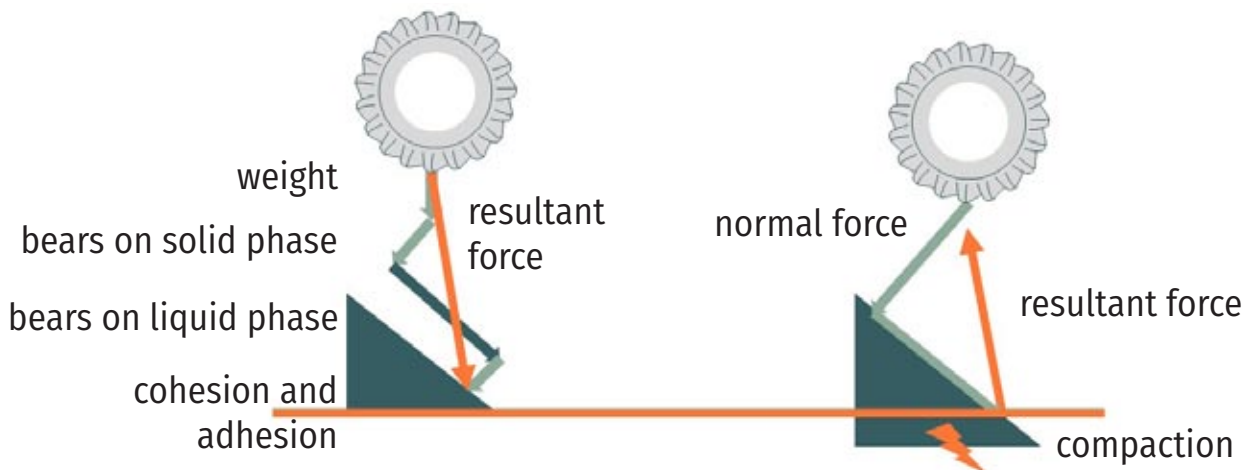

Figure 52: Forces of a wheel to soft soil

Plastic and elastic deformation

- **First compaction:** The larger pores collapse, and the soil is compacted.
- **Relaxation:** After the wheel has passed, the elastic component of the soil (roots, pores with compressed gas etc.) will push it back towards its original volume... But **the former level is seldom reached.**
- **Subsequent compaction (following passes):** When the load is the same as with the former traffic, the compaction and relaxation are as high as before.
- Finally, there remains a **permanent rut.**

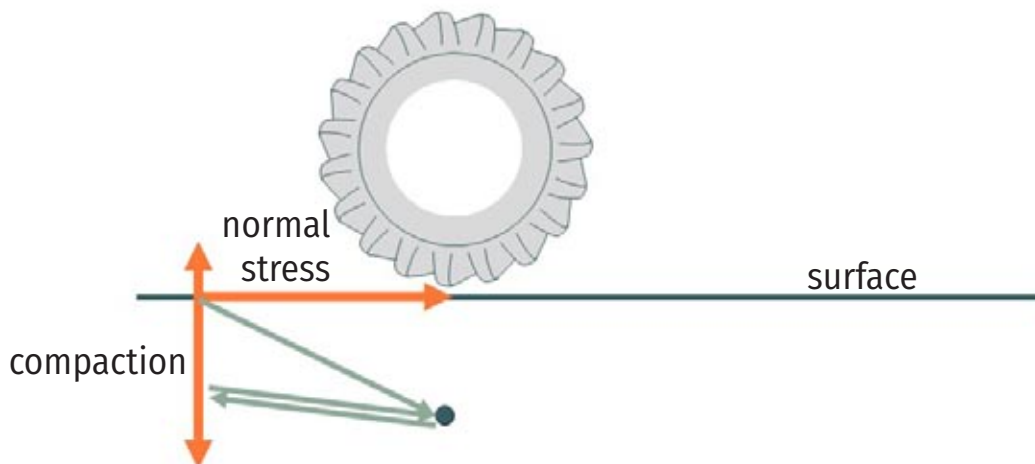

Figure 53: Compaction of the soil by a wheel



Sectors under a wheel

The isobars under the load are shaped like onion peels. Directly under the wheel, the soil is compacted the most (sector 1). But to the left and right of the main vertical push, the soil can relax against the neighboring soil particles turning the vectors around (sector 2). The parts of the soil near the surface give way to the pressure and are lifted (sector 3).

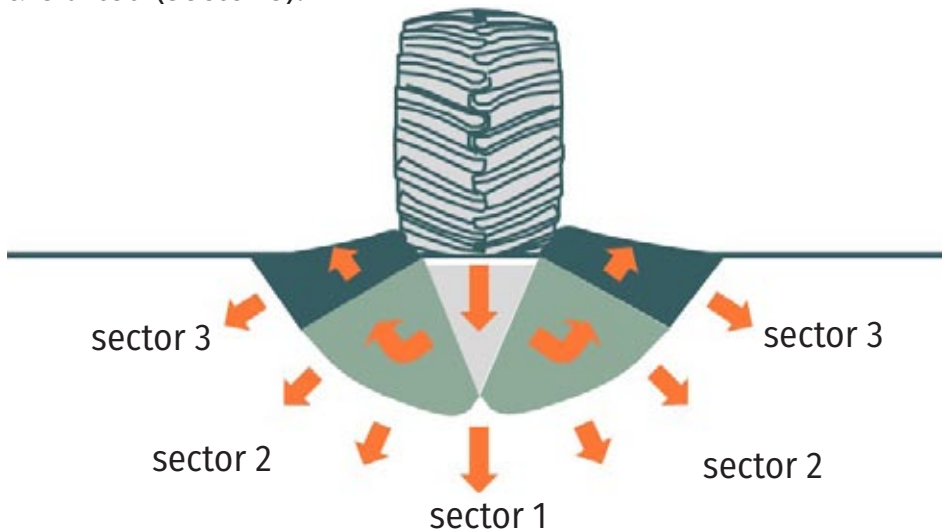

Figure 54: Sectors under a wheel

The quantity of compaction depends on several attributes:

- The soil type defines the compactibility.
- The actual moisture is an indicator of the fill level inside the tubes; tubes filled up with water cannot be compacted, the pressure goes to the side areas.
- High velocity is connected with higher dynamic forces that influence the structure much more than static forces.
- The first passages can be covered by roots, cohesion etc. by each passage these structures get weaker and break suddenly. As an experience, we often observe a collapse after five passages.

Regeneration of forest soils

Compaction can be regarded as a normal occurrence, like any other changes of the soil structure, which can happen without machine traffic, too. The important question is: will the soil be able to return to its original state by itself (resilience)? What are the natural forces that will open the pores and lift the surface again?

There are two main ways soil can recover from compaction, naturally:

- Abiotically through frost
- Biologically through the action of animals, roots...

Concerning biological recovery, organisms need to breath, so oxygen is required inside the soil pores. Or more exactly, the volume percentage of carbon dioxide must not be dominant. But what is the limit?

In general, we have the following information about the **development of Carbon dioxide** in the soil over the years:

Animal or human being: Directly after traffic we can see a quick increment of CO₂ in the soil pores. But after a couple of hours the percentage of CO₂ quickly goes down again. We believe that the pores in the soil are opened again by biological activities. Thus, though the specific soil pressure is high, the affected volume of soil is small, and recovery happens very quickly.

Lighter machines: When a light tractor (< 5 t) drives on the soil, the impact is higher. For the first few months, the percentage of CO₂ is significantly higher, but there is a tendency to recovering during the first year. Of course, much depends on the gross weigh of the tractor, the number of passes, the soil type, the moisture... so, driving with tractors seems to approach the limits.

Harvester: When a harvester, which has a gross weight > 15 tons, drives on the soil, the impact is so high, that the percentage of CO₂ increases in the first few months and may exceed the 1,0 %vol threshold. Yet more alarming is the fact that over several years there is no clear tendency towards recovery... When the next thinning happens in roundabout 10 years, then the soil has not yet recovered.

Forwarder, skidder: This tendency gets clear as soon as heavy forest machines drive on the soil several times. Here, the soil shows no tendency for recovery.

Thus, we assume that the limit is at 1,0 %vol of CO₂ in the soil pores.

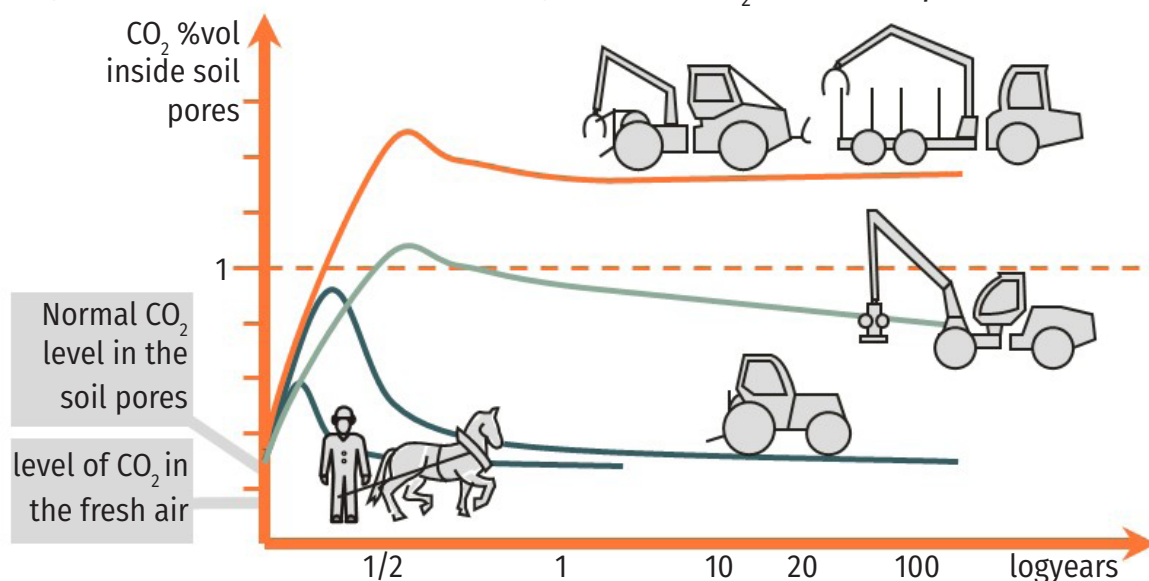

Figure 55: Carbon dioxide in the soil pores after traffic



Natural recovery

This knowledge about the reaction of forest soils has led many foresters to the following decisions:

1. We accept the fact that a soil trafficked by heavy forest machines will be damaged and will not recover within a reasonable time.
2. This means, that a trail has changed its function for a long time: though it looks like forest soil, it will not serve as productive ground but mainly as a trail.
3. Therefore, we must be careful, that it will retain its technical function as a trail in the future and will not be destroyed.

This is the **principle of permanent trails**: Once compacted, then skid trail forever!



Figure 56: As a general rule, the soil will not recover for itself after disturbance



D03 Soil repair and prevention

Why to predict technical damage?

If a strip road is destroyed, it must be repaired with a technical intervention. But this should be the last resort. Therefore, we should be able to predict the risk of destroying the strip road and prevent destruction in the first place.

There is a simple method that is used by soil scientists: Roll a lump of soil in your hand. If it remains stable, then the soil will bear the machine without much trouble. If you can form it well, the soil is close to its limit.

WSL (Switzerland) has classified **ruts** on trails according to **three types**:

- With type 1, we can see small ruts that witness to some degree of compaction, but there are no ridges on the sides. This type of rut is very stable and allows for further passages.
- With type 2, ridges appear at the sides of the ruts: they are derived from the soil being pushed aside by the wheel. This type is stable, too, but the ridges are a warning that we are close to the limit and must be very careful.
- With type 3, new ridges appear that are derived from semi-liquid soil flowing out of the ruts. This is a clear indicator that traffic must be stopped.

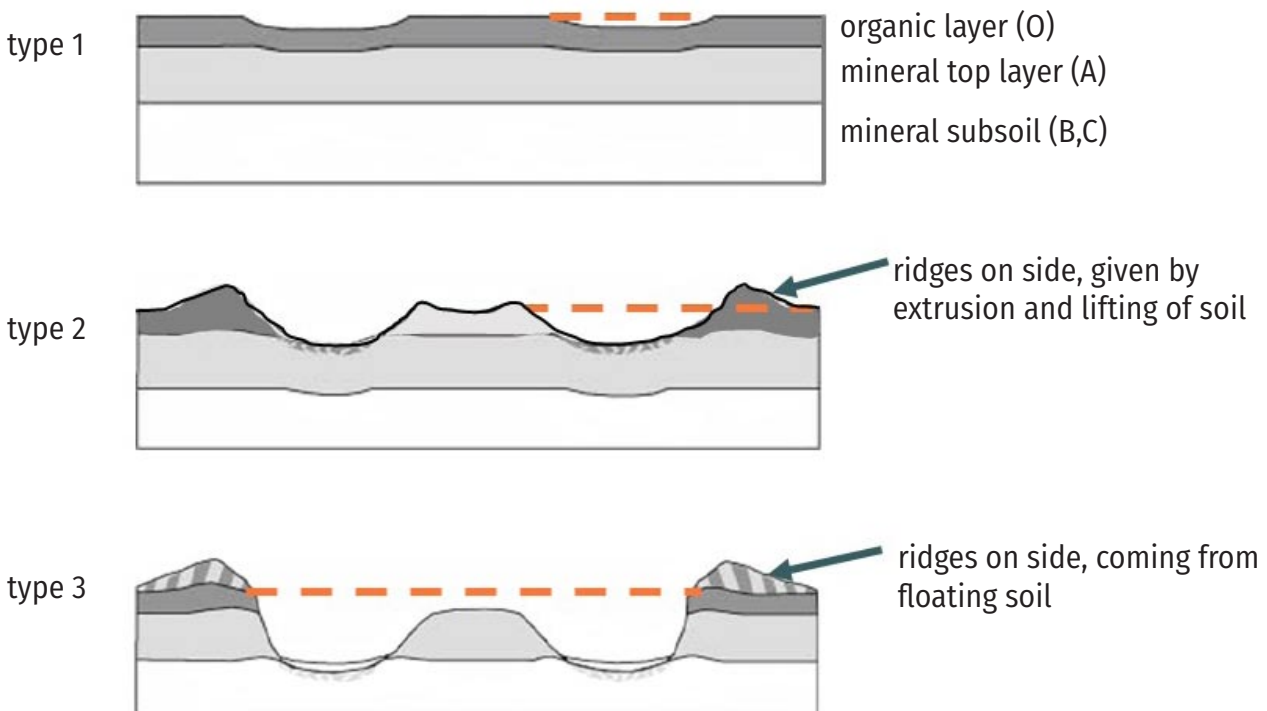

Figure 57: Types of ruts following the systematics of WSL, Switzerland



A poster from LWF (Germany) can be used for practical reference:
If you have the type 1 and the soil lump is stable, you may drive.

If you have the type 3, then stop driving immediately.

If you have the type 2 and the soil lump can be formed easily, you should try to drive very carefully:

- if the ruts stay at type 2, then go on driving
- if they turn to type 3
 - reduce the load or the tire pressure and repeat the test
 - if they still turn to type 3, then stop!

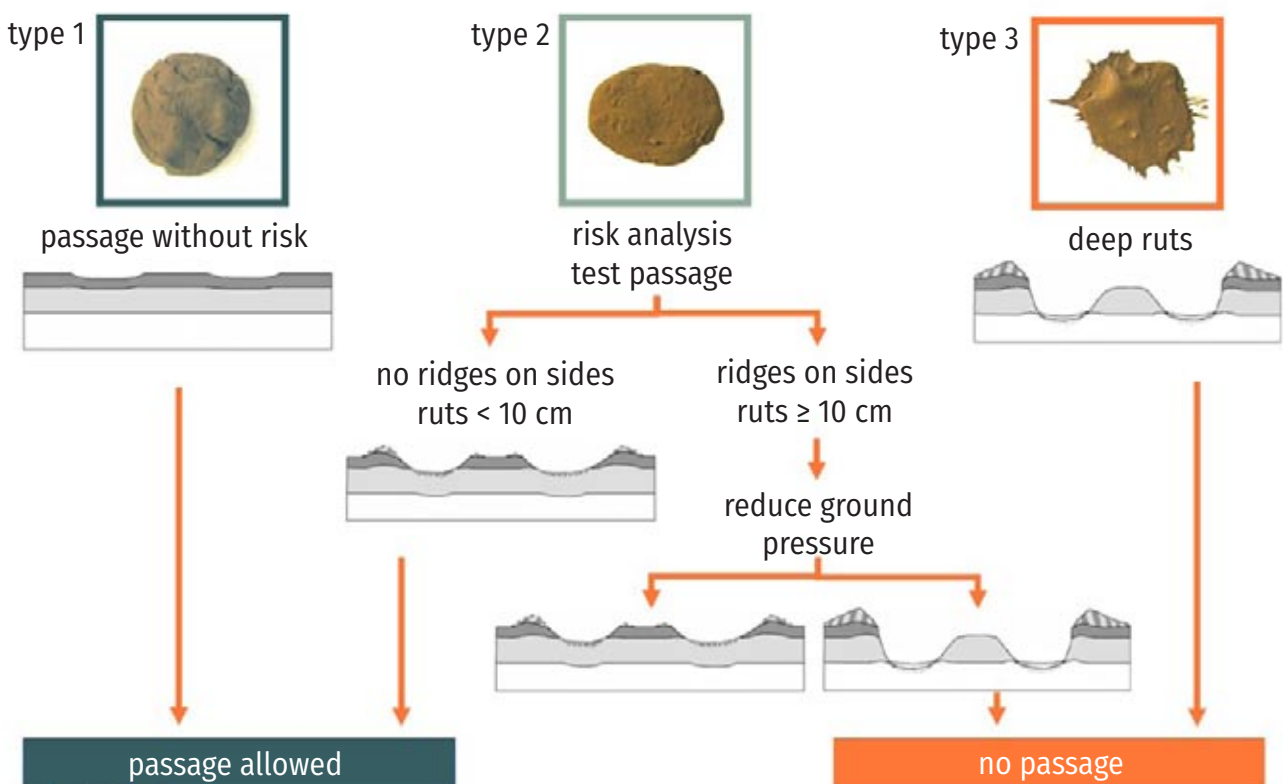

Figure 58: Decision making tool for machine drivers predicting the rutting after traffic (LWF Germany)

Systems like this give good advice to the driver and the contractor. Their disadvantage is that they only work in the immediate. They cannot be used for planning before actually starting with the operation.



D04 Avoiding soil damage

Saxony's technology guideline

In 2006, the state forest of Saxony (North-Eastern Germany) introduced a guideline that aimed to forecast the stress on the soil in order to avoid soil damage in advance by suitable harvesting methods.

This guideline is based on three main information streams:

- soil moisture
- inclination of the terrain
- sensitivity of the soil.

A **technological map** was developed to make these three dimensions transparent for every single stand. With this map, a set of appropriate working methods is connected from which the user can select that one that fits best to the local environmental conditions. This correlation between stand and methods is binding for all forest officers in the state forest of Saxony.

This approach has sparked a heated debate because it demands to enlarge the distance of the trails from 20 to 40 m as far as the soil has a higher **sensitivity**. The opponents argue that this will increase the harvesting costs without any compensation. So, it prevents earning a decent income in forestry.

T-class and P-class

Technodiversity looks for a solution that is more flexible and reflects the European diversity. As a proposal, we suggest the following decision-making tool:

The first crucial criterion asks how much the soil will react to any technical impact. This reflects the scientific context of traffic on bare grounds. As the guiding criterion, we ask for **trafficability** on the ground and divide it into five **T-classes**.

One very important reason for trafficability can be the **soil moisture**: On dry soil you can drive nearly without restriction. The higher the moisture is, the higher is the danger of rutting. So, in the figure we correlate the soil moisture given by soil sciences with the T-classes.

As the second order we take over the Saxonian idea to introduce different **distances of the trails**. But in contrast to that normative way, we hand over the decision to the forest owner, asking him: "How much of the site's productive potential are you willing to sacrifice to the technical function?"



P-class > trails

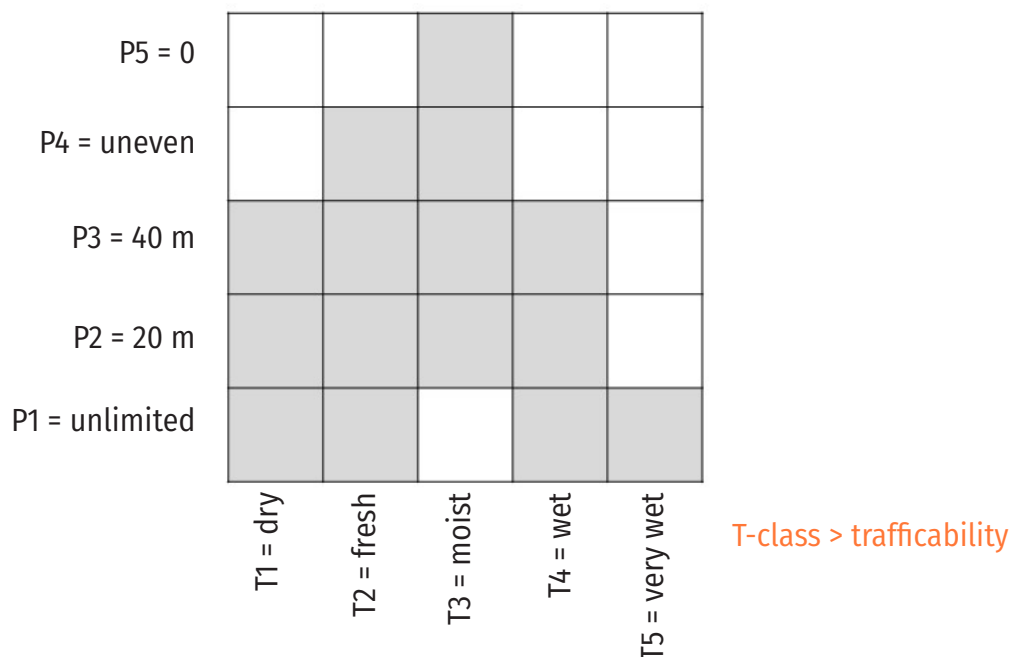

Figure 59: Basic structure of a technogram with T-classes for trafficability and P-classes for the soil value

Again, we introduce five categories (**P-classes**), depending on the value of the stand:

- P1: At a stand with low value (rocks, pure sand), any possible damage of traffic is not as important for the owner. Here, any patternless traffic is no problem for the owner.
- P2: At a medium-value stand, where the advantages of fully mechanized methods are dominant, up to 20 % of compacted soil is acceptable.
- P3: At a high value forest stand, where the owner sees the biological needs prior to technical needs, compaction should stay under 10 %.
- P4: At a stand with a very high value, the technical considerations should be restricted to a minimum, say roundabout 5 %.
- P5: Finally, at a stand with an extreme high value, no machine traffic on the floor is accepted.

With trails that have a width of 4 m their maximum length per hectare is:

- P1 unlimited, this means that driving is allowed everywhere
- P2 500 m that corresponds with trails that have a distance of 20 m each
- P3 250 m, meaning 40 m distance
- P4 125 m, say trails on old given, uneven routes with mean distance of 80 m
- P5 no driving with machines at all.

Technogram of the stand

Now we intersect the P-classes with the T-classes and obtain a 5 x 5 matrix. As a principle, all 25 fields can be selected. But if the owner decides that for him the value of a forest stand is correlated with its biological productivity, then some combinations of P-classes and T-classes are quite unlikely (i.e., dry and very productive, wet and very productive, moist and not productive). Under this condition, only 15 “fields” are filled up (see Figure 60).

The intersect between T-class and P-class is an assessment only for **normal weather conditions**. In case of a **dry weather**, the soil may dry a bit and behave like a soil in the T-class left to the original one. And when it has rained for several days, then we move one column right because the soil now behaves like a **wet soil**. During this adaptation of the T-class, the system of opening-up that is fixed by the P-class does not change.

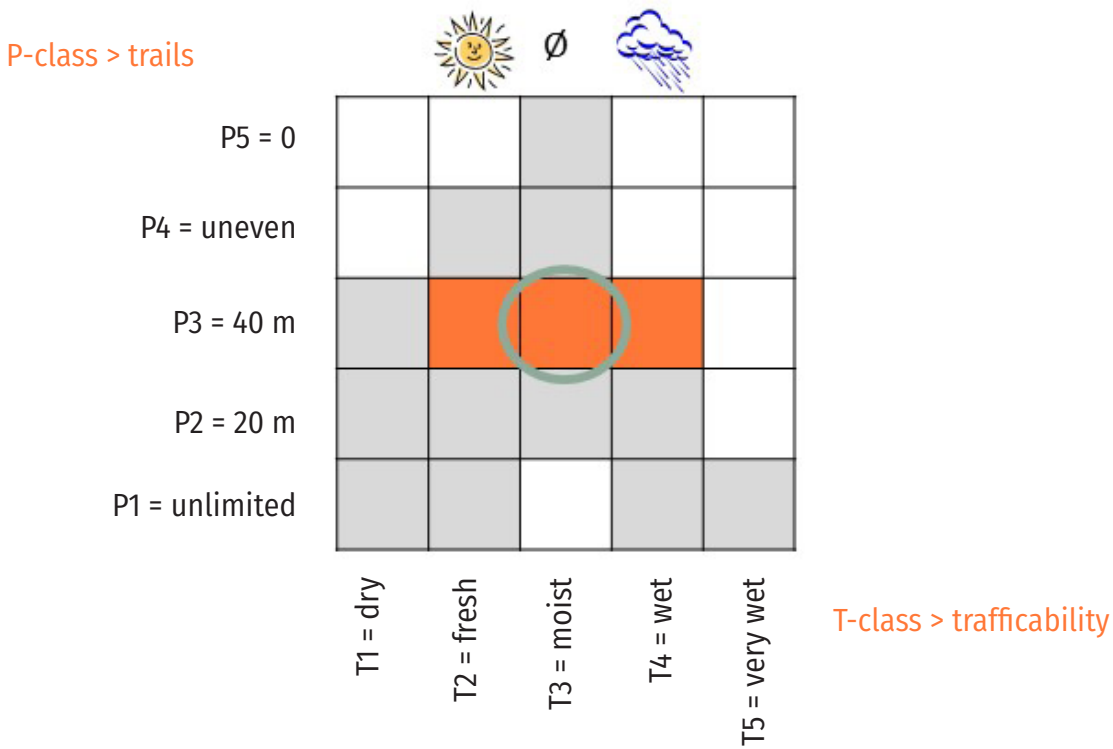

Figure 60: Technogram for a stand with T-class 3 and P-class 3; under dry conditions move to T2, under wet conditions move to T4



Ecogram of a harvesting method

The technogram indicates the behavior of the soil under technical stress. This stress is typical for a certain harvesting method and can be forecasted. So, we construct “ecograms” that correspond with the structure of the technograms and are valid each for one working method. They indicate whether the method is optimal, good, limited or not acceptable.

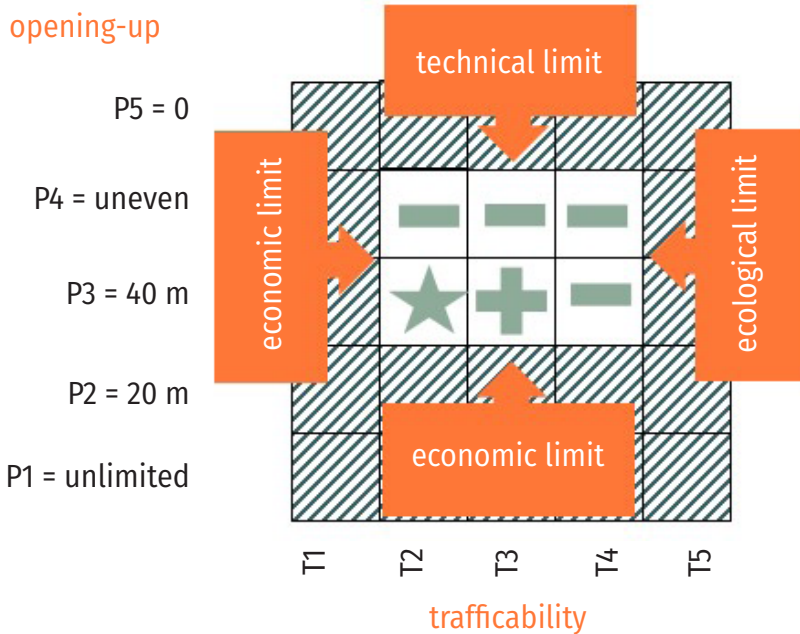

Figure 61: Structure of an ecogram of a working method that is perfect for T2-P3, good for T3-P3, and acceptable for T4-P3 and P4 with the T-classes 2, 3 and 4

The upper limit of the suitability area is defined by technical restrictions: A harvester has its limits because of the length of its crane. Other methods are limited by the maximum length of the pre-skidding devices. And all methods, where machines must drive on the soil, cannot work at P5.

To the right side (towards wet soils), the damage on the ground limits any acceptance. Heavy machines are perfect for dry soils, good on fresh soils, and come to their limits with moist soils. If there are aids like bogie tracks or traction chains on the wheels, compatibility moves one column to the right.

The left and lower limits are given by competing methods, that are better for those conditions than the observed one. No one who knows these alternatives would decide to take the option in dispute, because it is too expensive, too cumbersome or just not necessary for those conditions.



D05 Solutions for trafficable areas

The ecogram of a total process

The compatibility of a working method results from the compatibility of all its sub-processes. Each sub-process has its own, typical ecogram. It is valid and does not depend on other sub-processes. That means that we first must find (or construct) the ecogram of each sub-process. The question is how to come from the ecograms of the sub-processes to the ecogram of the total harvesting method? Or in other words, how to combine those separate assessments?

For each field in the ecogram, the worst assessment of all sub-processes is used as final assessment for the total method (“bottle-neck-rule”).

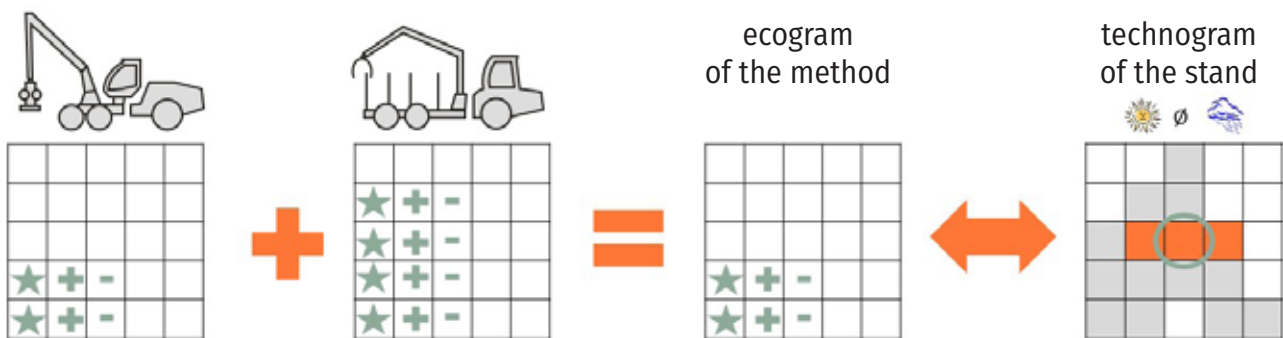

Figure 62: Combination of harvester and forwarder with their ecograms and combining them to the ecogram of the total process; due to the bottle-neck-principle the process is only acceptable where the harvester can work; and finally, the method does not meet the needs

In the case that two sub-processes are combined in order to work in different parts of the stand (like harvester and motor-manual felling, e. g.) the ecograms must be adjusted together. In the example, the combination of harvester and chainsaw is specialized for a pattern of skid-roads with 40 m distance. Consequently, it is only acceptable under P3.

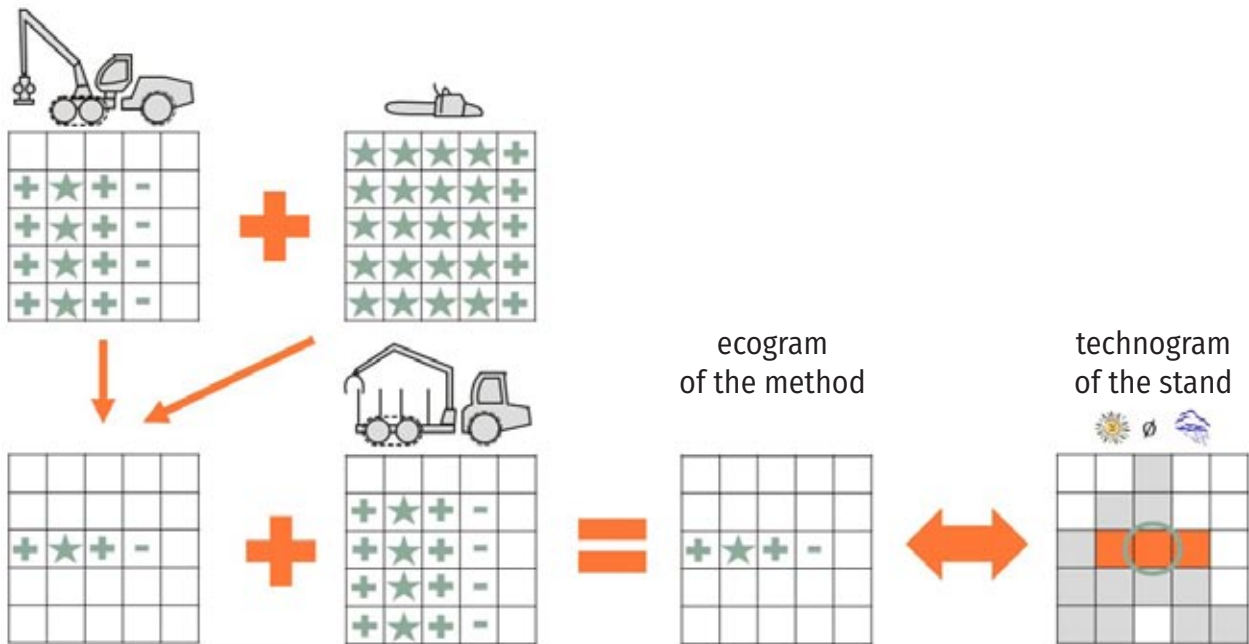

Figure 63: Harvesting method for trails with 40 m distance; here the assessments of the harvester and the chainsaw are condensed to a specified ecogram that only is suitable under 40 m distances

Standard methods on trafficable terrain

For each field in the technogram, in most cases there is one method that can be regarded as standard.

In simple situations, where machines may drive on temporary trails (=P1) or on **permanent trails with 20 m distance** (P2), the combination of harvester and forwarder (fully mechanized ctl-method) has become standard. This method is very good for T-class T1 (dry) and good for T2 (fresh). When the stand turns to moist, it is best to use equipment fitted with bogie-tracks or traction chains.

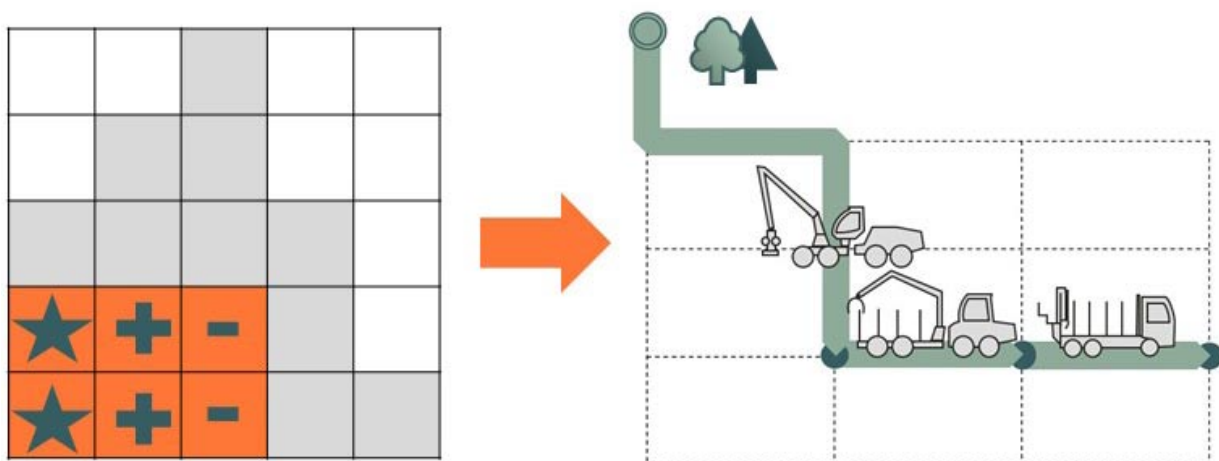

Figure 64: Standard method for P1 and P2 under dry and fresh conditions: harvester and forwarder

If an owner decides for a **40 m trail spacing**, it imposes auxiliary felling for the zones outside the harvester reach. This almost fully mechanized method can be seen as standard in coniferous and younger mixed stands with 40 m trail distances.

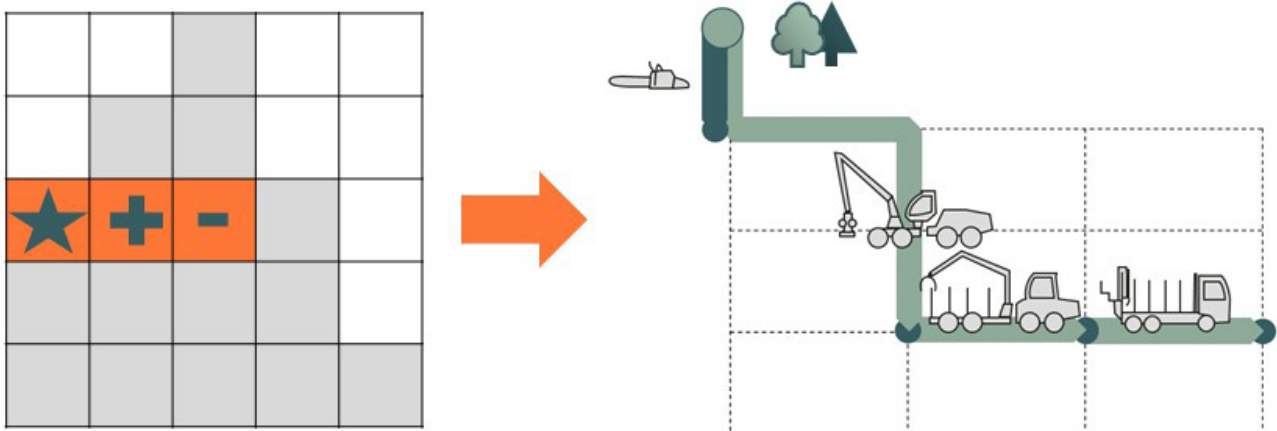

Figure 65: Standard method with spacing 40 m on dry and fresh soil: harvester plus motor-manual felling and forwarder

With **wider trail spacing** and normally in hardwood stands, felling is done motor-manually with the chainsaw. Because it is more efficient, we prefer here to extract tree lengths instead of short logs. Extraction can be divided into two steps: pre-skidding by horse and skidding by tractor (partly mechanized tree-length method). The damage potential of the tractor sets the score. As an alternative, pre-skidding can be done with the winch installed on the tractor. This method remains partly mechanized, as well.

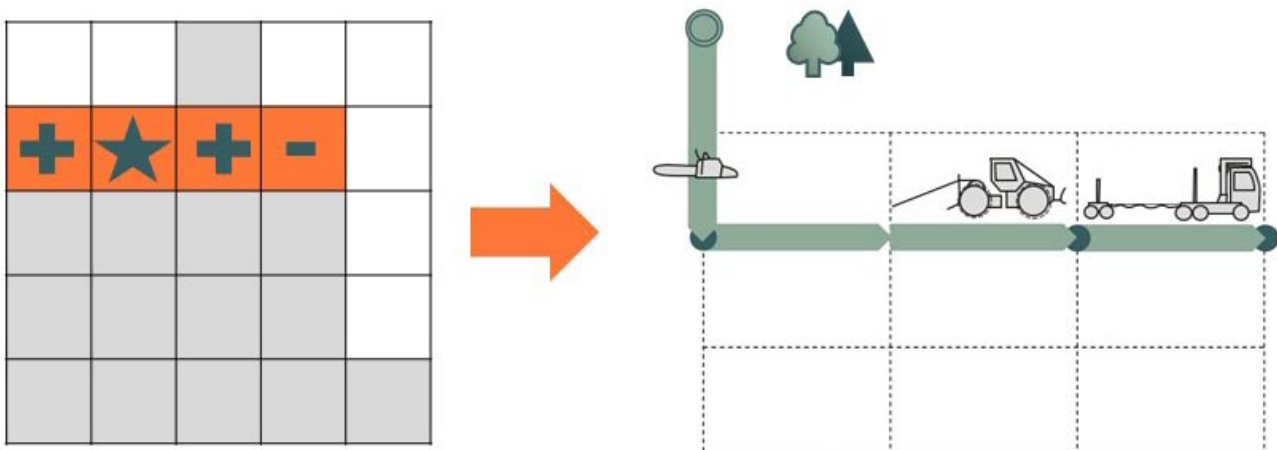

Figure 66: Standard method for stands with wide spacing of trails: motor-manual harvesting of tree lengths and extraction by a skidder



As a simple overview, we can sum up that very few harvesting methods have become **standards**:

- In stands with temporary trails or permanent trails with 20 m spacing, the fully mechanized ctl-method is best for coniferous trees and for young broadleaved trees, too.
- Where the 40 m trail spacing is adopted, the highly mechanized ctl-method with auxiliary felling by chainsaw sets the standard.
- At wider trail spacing, which happens mainly in valuable hardwood stands, partly mechanized tree length methods are preferred.
- Outside trafficable areas, the partly mechanized method with a yarder is the most effective solution for harvesting.

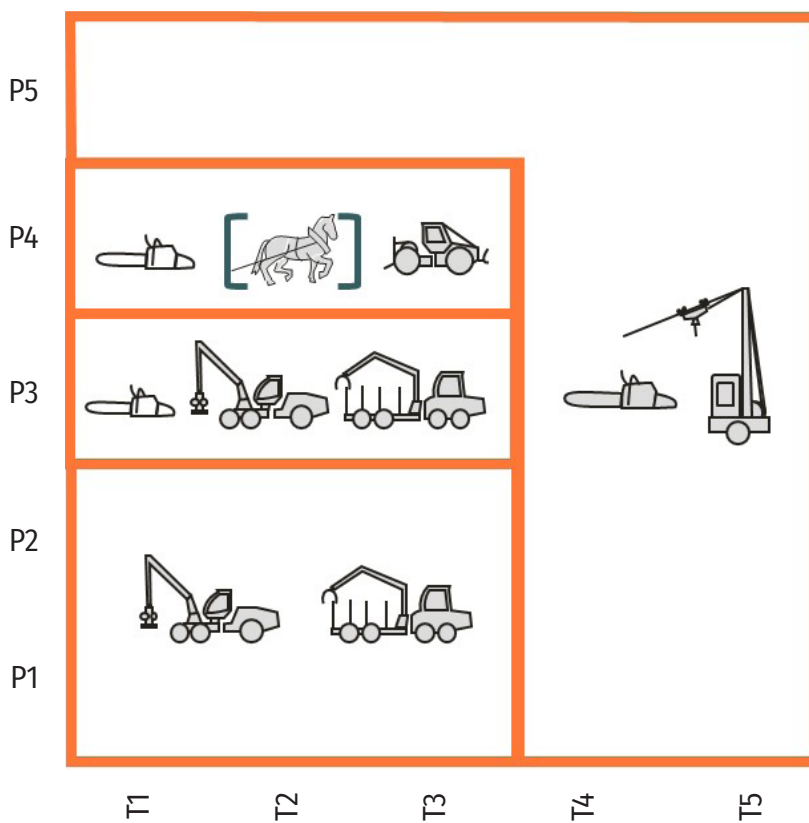

Figure 67: Standard methods for all T- and P-classes



E SOCIAL SUITABILITY

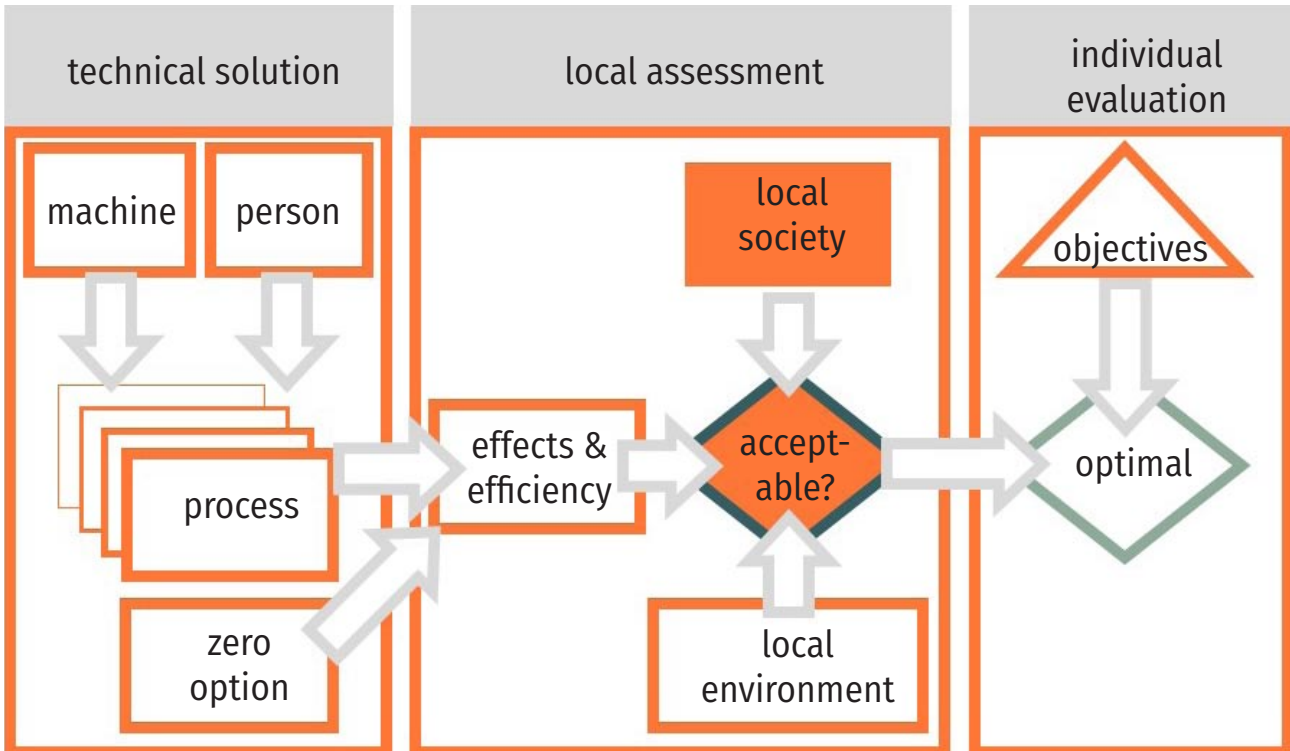

Figure 68: Decision-making should also consider societal needs



E02 Societal compatibility

Local rules and laws

Concerning the basic concept of “Technodiversity”, decision making also should respect local societal needs. This is an overall remark; the weight of these needs can differ from place to place.

In some cases, the local society has developed a specific sensitivity against human impacts to nature in general, and forest land in particular. In other cases, people fear that forest activities can destroy historical sites, natural monuments etc.

But the correlations with harvesting activities are too specific for drawing general rules. When an issue arises, decision makers need to manage it individually.

Very often, restrictions are explicitly formulated as laws, landscape plans or other regulations. Obviously, official **regulations** must be heeded to, and if any such regulations concern an operation, they must be considered from the beginning at the planning stage. When selecting the most suitable system, any option going against such regulations must be immediately excluded from the list.

Enhanced needs for employment

Depending on local economy, **underemployment** can be an issue. In that case, forestry may offer an opportunity for unskilled workers and therefore it represents an asset for the local society. For that reason, decision makers may favor **labour-intensive** logging systems that do not require specialized workers as mechanized systems do.

A good attribute to measure this is the **degree of mechanization**:

- As a tendency, manual methods achieve very low productivities but offer employment to workers with low qualifications.
- Partly motor-manual methods demand for better skills but achieve a relatively low productivity, too.
- Fully motor-manual and partly mechanized methods need well educated and skilled workers, such that not every job-seeker is viable.
- Fully mechanized work has the lowest employment potential, since it relies on very few but highly educated operators.

Urban population seeking recreation

Another aspect is the potential to get in conflict with people who seek **recreation in the forests**. This group of forest users are not homogenous and so their demands are diverse, too. This makes it difficult to fully meet their needs.

Some studies have tried to describe this population of forest users. We quote the research work of Kleinhüchelkotten from 2009, who correlated forest visitor's characteristics with SINUS-milieus for Germany at the beginning of this century. Though it is obvious that the results cannot be transferred to other countries without adaptations, the basic information seems to be relevant in general:

- About 22 % of the sample is classified as **“holistic forest friends”**. These people like natural forest structures and believe that modern forestry will assure sustainable yield of products and sustainable forest functions. This group is relatively comfortable with forest technology.
- The **“ecological forest romantics”** represent 16 % of the sample. They regard forests as highly organized natural organisms that require our full care. They believe that conventional forest operations are a threat and should be modified for additional sustainability. This group of visitors has very little interest and acceptance for modern forest technology and are often vocal about it.
- The **“pragmatical distant persons”** represent 23 % of the total and form the biggest group. They see the forest primarily as a material resource. They believe that forestry performs well and like it when a forest looks organized and cleaned up. This group supports efficient forest technology and may complain when efficiency is sacrificed to nature conservation.
- Another large group – 22 % – can be described as the **“self-centered forest users”**. For them, the forest is no more than a backdrop for their hedonistic activities, such as playing sports, picnicking etc. They regard any limitations as the unacceptable restriction of their freedom. As such, they are not amenable to restrictions caused by forest activities, regardless of methods and technology.
- There is also a relatively large group, with 18% of the total. The **“indifferent persons”** feel no emotional connection with forests at all. If they talk about forestry, they assume that forestry is too primitive for them. Often, they don't accept that forestry earns money with forest products. Fortunately, members of this group will seldom visit a forest.

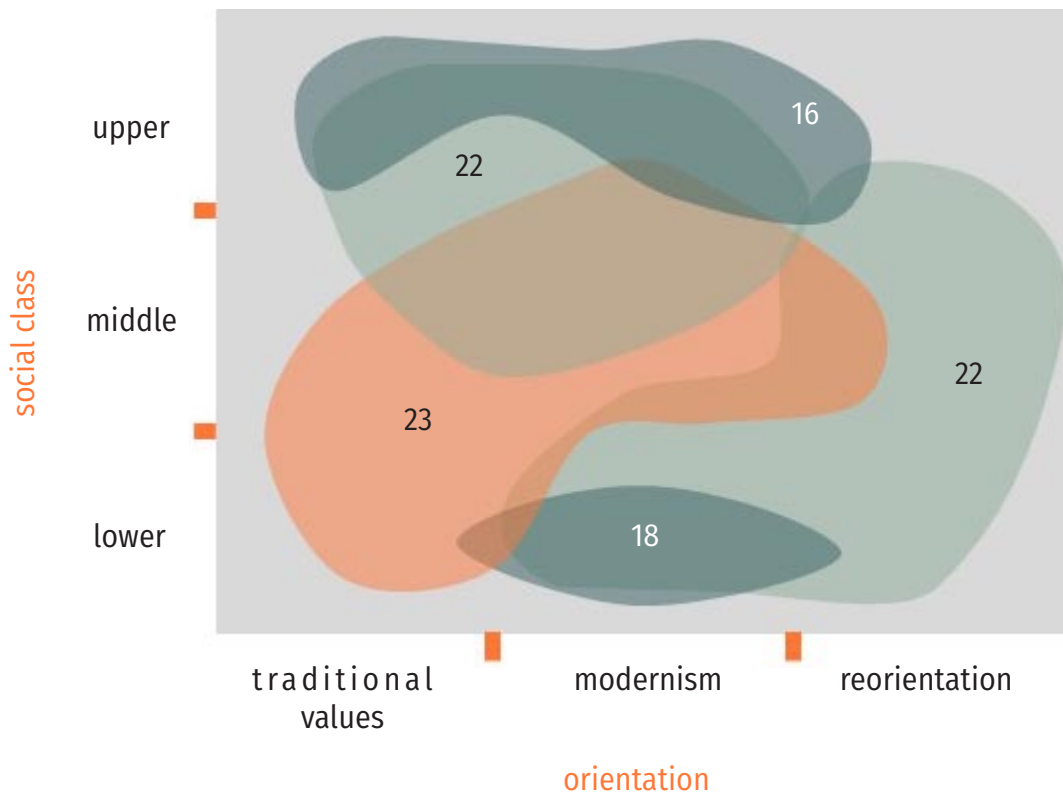

Figure 69: Forest visitors in SINUS-milieus (Kleinhüchelkotten et al.); top-down: ecological forest romantics, holistic forest friends, left: pragmatical distant persons, right: self-centered forest users, indifferent persons

One common need is true for all forest visitors: they use the forest roads as their access to the forest and don't want to be disturbed while using them. If we cannot keep the roads clear from forest machines and operations, people will have some problems to accept our actions.

S-classes

This leads us to five classes (S like social) depending on the question of how much forests roads are impacted by forest operations:

- S1 chipping of wood on the forest road or storing chips there; since it produces noise, dust, and trash on the ground. This is the worst S-class = arrow ending at 34
- S2 processing round wood on the forest road; there is a high movement of the machines on the road with high impact to the surface and cleanliness of the road = arrow down ending at 32 or 33
- S3 unloading and loading of tree lengths or full trees along the forest road; since the logs are pulled on the floor, the impact is relatively high = arrow from 22 to 32 or 21 to 31
- S4 unloading and loading of short wood along the forest road; since the products are carried on the machine and unloaded with help of a crane, the impact is low = arrow from 23 to 33
- S5 all actions take place outside the forest roads where the public wants to recreate; this situation is perfect under this aspect and gets the best S-class S5.

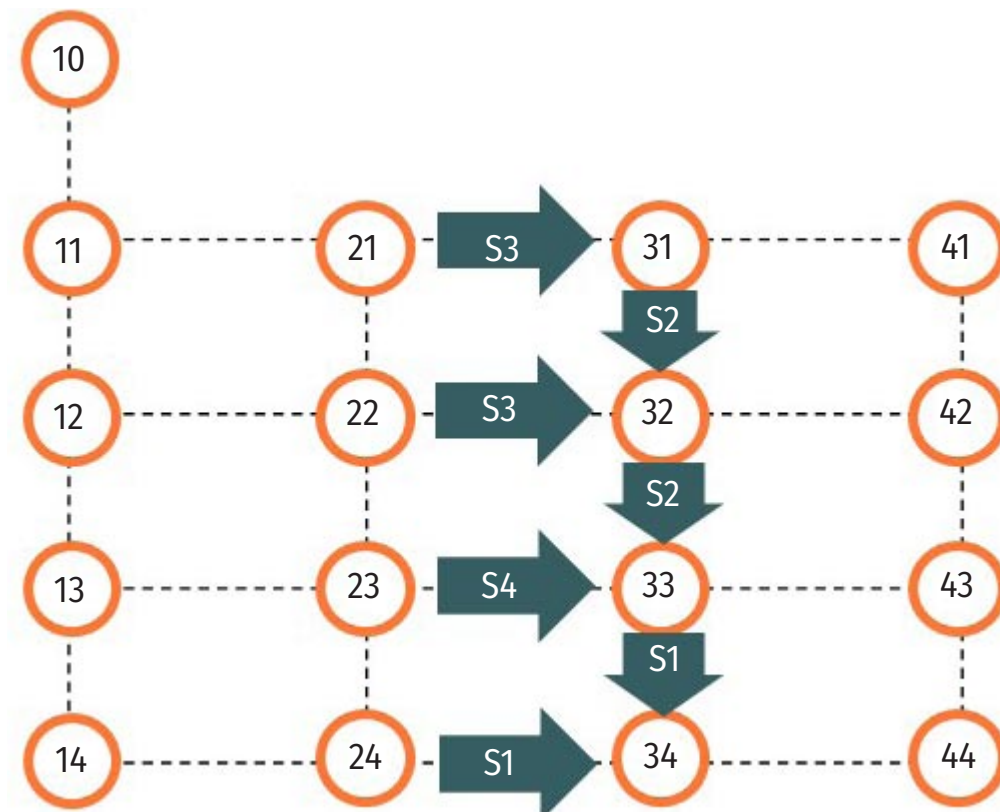

Figure 70: S-classes describing the disturbance of forest visitors on the basis of functiogram



E03 Working stress

The standard method as basis for assessment

The **working process** describes what happens with details about tools and machines, working steps, time consumption, results etc. The **working method** indicates what must be done; main information is the machines, the working steps and the working result. The **operational method** indicates how the worker must act to reach the desired result. The **manner of working** is the real way how the worker makes his job, sometimes also including tricks and deviations from safety rules.

When we deal with working processes and want to assess them under the ergonomic point of view, we must define exactly the working method, set the best practice and train the operational method of the workers. We call it the **“standard method”**.

Stress at work

When we follow the standard method, the sequence, duration and intensity of each single stress event is quantified by the method itself. The overlap of different stressors with their complex intercorrelations is automatically regarded, too. This mixture of stresses is typical here.

This means, that the standard method forms a complex stress assessment package that can be seen as a black box and must not be measured in detail.

In forestry, other sorts of stress can occur:

- The natural environment can be extremely diverse.
- Social relations with colleagues and superiors may cause stress, too.

In order to simplify the model, these stressors are set apart when we assess the stress that comes from the standard method.

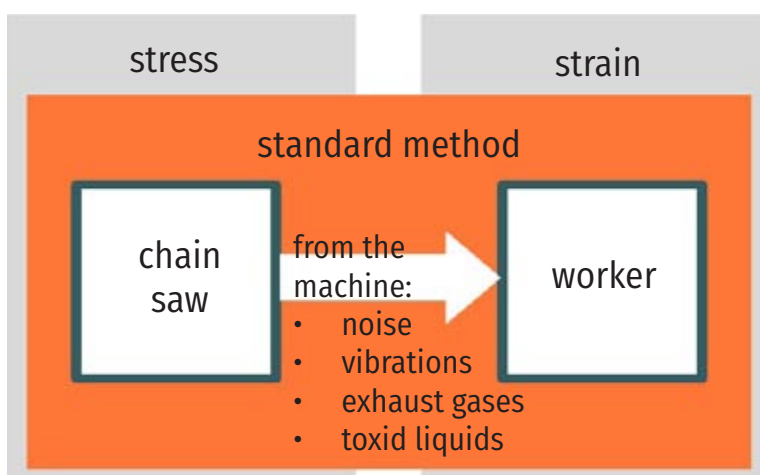

Figure 71: Components of working stress due to the standard method

E04 Strain at work

Total stress and different strains

The stress that is typical for a standard method will cause different **strain** on different workers, because people are individuals:

They have different **attributes** like gender, age, height, weight, power. In practical life, these attributes are regarded to be invariable.

Everybody has their individual **abilities** and strengths. The same job that is easy for somebody can be difficult for another person; we say that the first person is more talented for this job than the other one.

Most jobs require a certain technique. **Skilled persons** can reach results that will never be possible for unskilled persons.

These three factors together – attributes, abilities and skills – form the **capability** of the person. If their capability fits the demands of the standard method, the strain is low. If not, strain will keep accumulating.

When the worker can manage his workload independently, he can find the right pace to keep strain at an acceptable level (**readiness**). But there are situations when the strain exceeds that level. For example, when the worker is pushed to reach a certain performance that is beyond his long-term capacity or when he is so motivated that he does not realize that he is overworking.

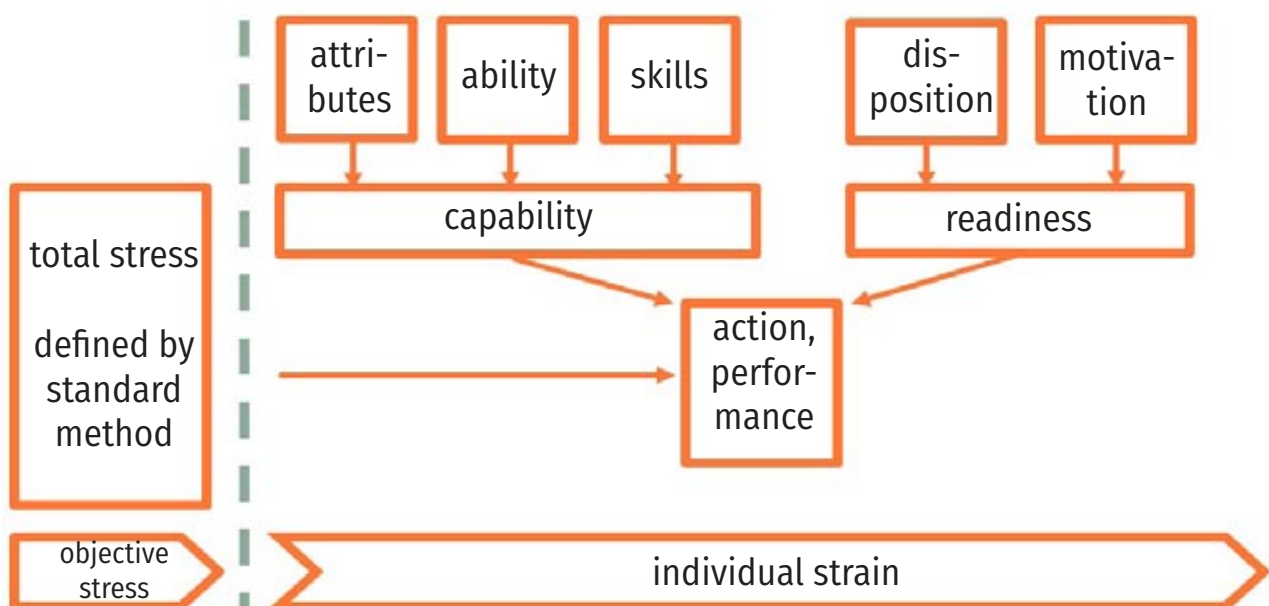

Figure 72: With standard stress, the strain depends on the working capacity of the worker and the actual readiness for the work



Strain and excessive demand

If the worker suffers from a condition, the strain will increase much quicker and reach dangerous limits earlier.

The strain is complex but can be measured with some indicators. For each indicator we can define a **permanent load** that can be coped with on a day-to-day basis until the worker retires. If the actual strain momentarily exceeds this permanent load, it will not be a problem. It can even improve the training and exercise (**conditioning**). But there should be a balance between periods of excessive strain and periods of lower strain (**recovery**). Otherwise, overload will accumulate and result in damage.

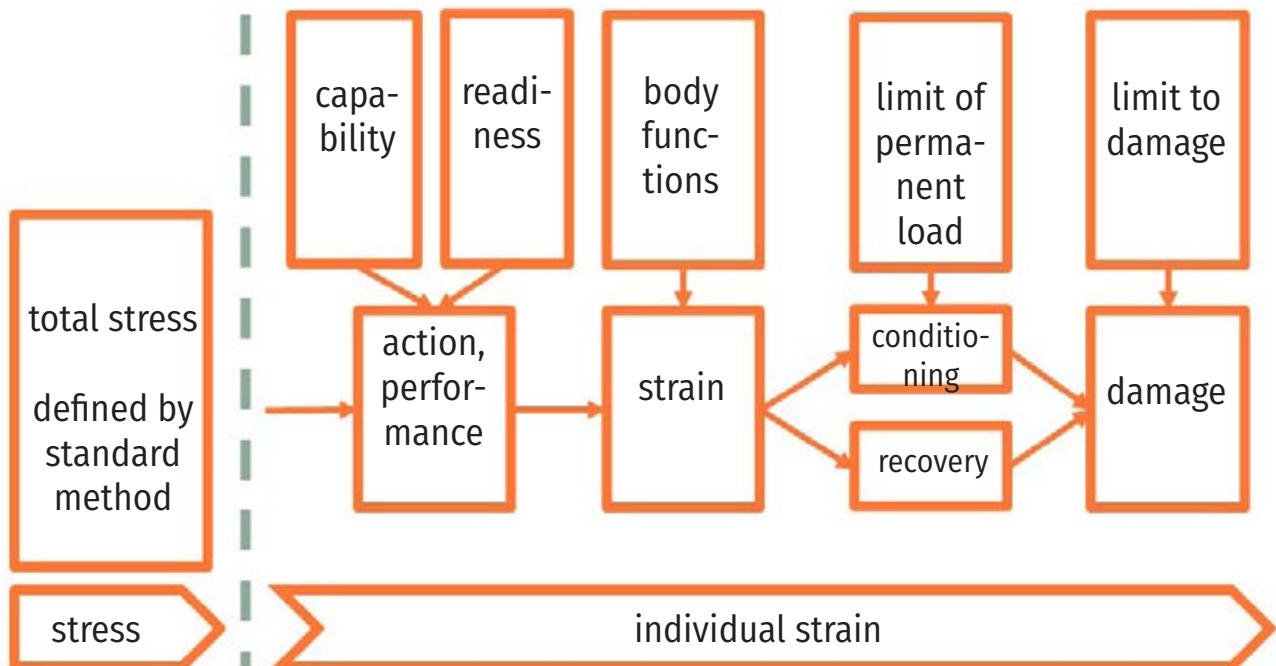

Figure 73: Model of stress, strain and damage in working situations

Actions to limit the strain

Based on this model, there are various possibilities to lower the strain. It is up to the manager to combine them in the best possible way, by:

- providing enough time for breaks adequate to the type and quantity of strain (recovery)
- encouraging physical and psychological fitness through proper exercise and diet (conditioning)
- creating ideal working conditions to increase readiness
- adapting work assignments to the physical and psychological capacity of each worker.

Optimal fit to individual capacity

The ultimate measure is to assign tasks and to adjust the workloads according to each worker's individual capacity.

When we have different technical options for performing a certain job, we should prefer the option that fits best the capacity of the available workers. But concerning physical stress, we can deduce the strain from the levels of mechanization. These categories, here expressed by **E-classes** (E like ergonomy), correspond with the **risk of an accident**, too. In general, work safety improves as we progress through the various levels of mechanization.



Figure 74: simple assessment of strain by E-classes (ergonomy) based on the degree of mechanization





E05 Social suitability

Now, we can combine the assessments for ergonomics and societal compatibility in a 5 x 5-table.

The fully mechanized standard method with harvester and forwarder – for example – falls into the S-class S4, because on the road only the forwarder stores the short logs. No additional disturbance will occur. Concerning ergonomics, we have two E-classes: E4 for the forwarder and E5 for the harvester. Thus, for this fully mechanized CTL-method (here abbreviated by fmC) two fields are fixed: S4-E4 and S4-E5.

S5 clean roads

S4 short wood store

S3 long wood store

S2 processing

S1 chipping

			fm C	fm C

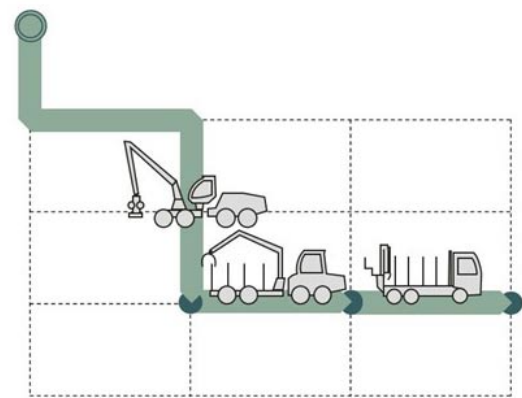

E1 manual work
E2 motor-manual work
E3 simple mechanized work
E4 advanced mechanized work
E5 automatic work

Figure 75: E-classes and S-class of a fully mechanized cut-to-length method

Another is the partly mechanized tree-length method (here abbreviated with pmT). It falls into the S-class S3, because on the road the long logs are handled and stored by the tractor. This can cause damage to the road and disturbance to visitors. Concerning ergonomics, we have three E-classes: E2 for the processing, E1 for the pre-skidding, and E3 for the skidding.

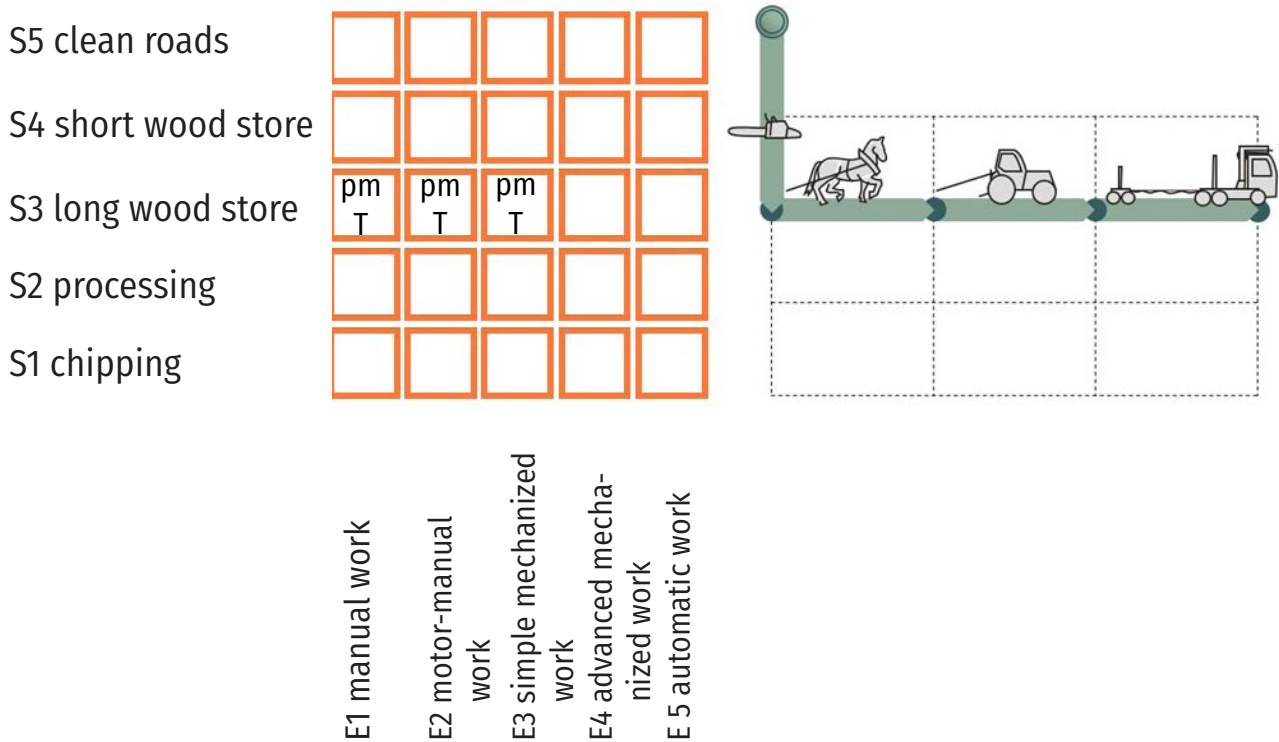

Figure 76: E-classes and S-class of a partly mechanized tree length method

Assessing the social suitability

Now the decision maker can mark his individual preferences. Here we chose traffic light colors to represent

- dark green = okay
- light green = limited
- orange = not acceptable.

One decision maker might feel uncomfortable with manual work due to safety concerns and prefer mechanized work, instead.



Figure 77: Example of ergonomic preference: The decision-maker prefers mechanized work (dark green) and does not accept manual work (orange)



Concerning compatibility with recreational needs, our decision-maker may want to avoid processing on the forest road. Loading operations, however, could be accepted without constraints. Consequently, S1 and S2 are not acceptable, but all other S-classes are okay for this decision maker.



Figure 78: Example of assessing societal acceptance: The decision-maker prefers all offroad work (dark green) and does not accept any processing on forest roads (orange)

When we combine those assessments, at each intersection the less desirable color is dominant (comparable with the bottle-neck-rule). In our example we see, that the fully mechanized cut-to-length method with harvester and forwarder (fmC) fits well to the societal assessment of this company, and that the partly mechanized tree length method (pmT) fails, due to the critical assessment of manual and motor-manual work.

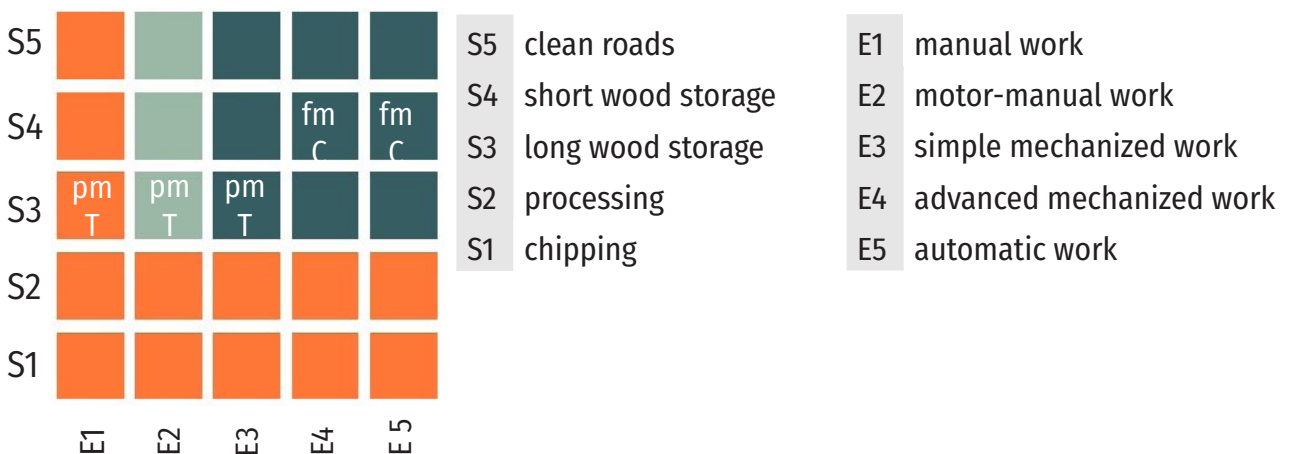

Figure 79: example of assessment of social suitability on the basis of individual preferences



F PATH TO THE OPTIMAL SOLUTION

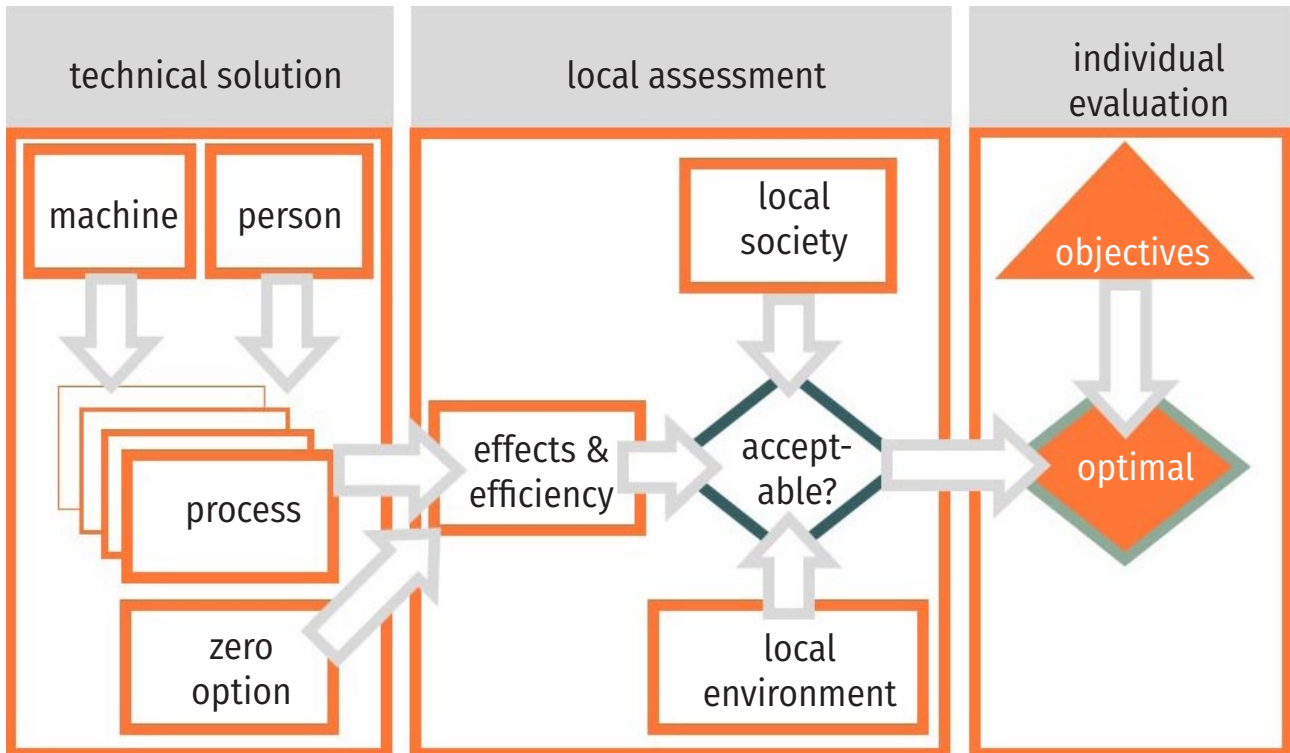

Figure 80: Third part of decision-making: To find the solution that is the best compromise for the individual preference or priority

In most cases standard tasks can be solved by a standard solution, which has proved a good one often enough.

But a single problem asks for an individual solution.

The three step model

TECHNODIVERSITY combines the assessments to a concise decision-making process. The first step is to look for all **options** that may be able to do the job. In addition, the **zero-option** is the ultimate fall-back option that allows to compare the technical solutions with doing nothing.

- The second step is to **assess** the options to find out, whether they match the local constraints. Those who fail must be dropped.
- In the final step aims to **evaluate** the options and to finding the one that fulfills the goals of the forest owner best.

F04 Selecting the best option

Evaluation using the “minimax rule“

This is a very simple method that is common in real life. Here, the decision-maker first eliminates any option that fails a certain criterion. After the elimination process, all surviving options are considered acceptable.

Next step is focusing on that single criterion that is the most important for the decision-maker. In real life, it often will be the monetary efficiency. If so, the decision-maker will select that one among the surviving options that offers the highest income.

Evaluation by monetarization of all criteria

Some economists point out, that evaluations deal with values. And values should be quantified in terms of currency, so that the easiest end is to add all values. That amounts to transfer the individual assessments to Euros, e.g. There are some models to do this in a fairly scientific way. But in some cases, we pass the limits of fairness and modesty. How to calculate the value of human health or of eco-efficiency? So, for as attractive this idea may sound, in practice it generates significant controversies.

Evaluation with utility analysis

This old method for decision making (Zangemeister 1973) uses **scores** like in school. Every criterion must be rated according to those scores. Often a value scale is used like:

9 = very good

7 = good, better than average

5 = expected average

3 = borderline, but not the worst

0 = not acceptable

Next, one gives a weight to every criterion according to its relative importance. The sum of weights should be 1.0 Finally, each score is multiplied by the respective weight and then summed up. The option with the highest score will be the favorite.

Scientists do not rate this analytical method too high, because it has a couple of mathematical bugs, that make it unscholarly. One of the most relevant critics is, that it uses mathematical operations that are not rational. In particular, the scores 0-9 are data on an ordinary scale, which only knows “more”, “equal” and “less”. Operations like adding or multiplying may not be done.

But it has one advantage: It allows for a transparent decision-making process.

Evaluation with AHP

In 1990 Saaty proposed a new solution based on paired comparisons, the analytic hierarchy process, AHP. Under each criterion we ask which one of two options is better. At the end we count the relations of the options. The option with the highest sum of “wins” is the best.

Using a sophisticated mathematical procedure (with linear analysis), this method finds the overall winner, but the method tends to exaggerate relationships because it does not discriminate between small and large differences. AHP is widely used in sciences – but only there. For practice life it covers too many hidden effects.

Evaluation with optimality curves

Another method that has been developed at Harvard University compares the efficiency and the effectiveness of each option against each other. This works well when there is only one effectiveness and one efficiency. Since we have three criteria, we need to adapt it a bit: We combine all efficiencies to one overall efficiency and all effectivenesses to one overall effectiveness.

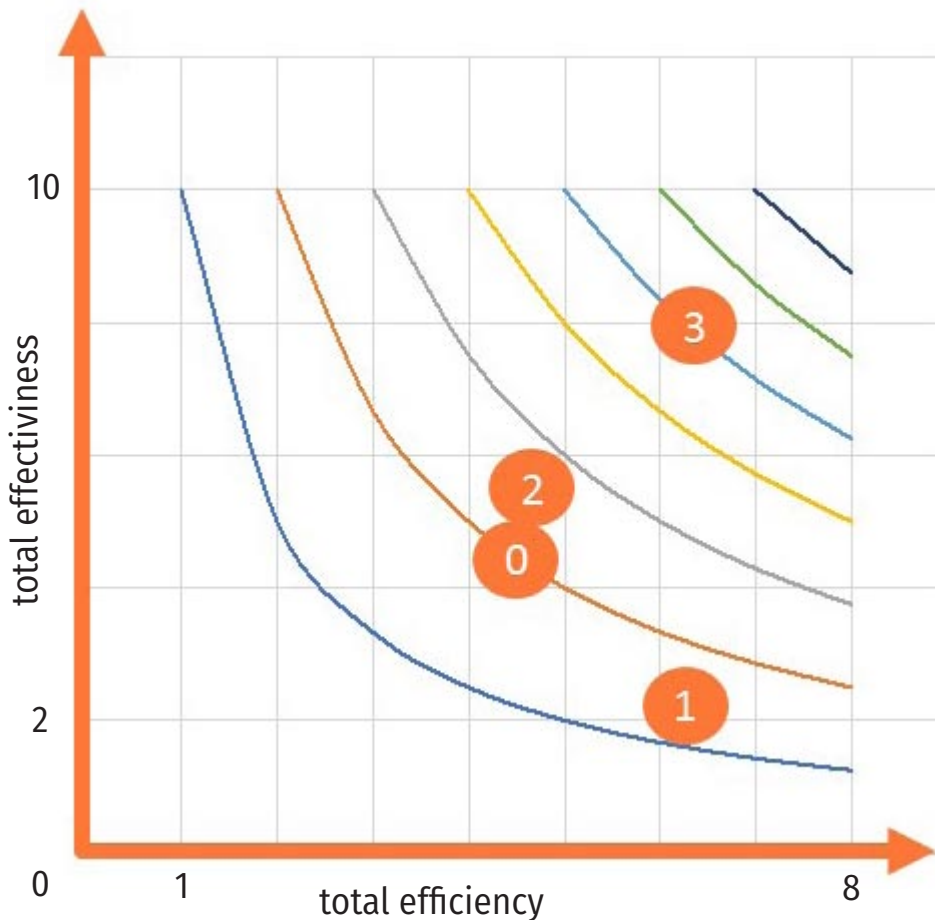

Figure 81: Four options on optimality curves (examples) that combine the effectiveness and efficiency of each option: here option 3 is the best one



The lines symbolize combinations with the same product (efficiency times effectiveness). The wider the distance from the source, the better the option. In the example of Figure 81, option 3 is on the highest optimality curve.

The advantage is that you can see the result with one glance. The disadvantage is that the table hides the combination of different “effectivenesses” to one effectiveness and the same with the three efficiencies.



F05 Target driven optimality

All decision-making models that were shown before ask for a pre-defined pattern of priorities or preferences. When the system of objectives is fixed, the result is more or less a mathematical question. But they cannot answer the question: what happens, when we change the objectives? Is there a **turning point** where the former best option stays back and another option becomes the best one?

Technodiversity suggests a method that exactly answers this question. To do this, we need some general agreements:

- The criteria are fixed by the six sub-objectives
 - Economic efficiency
 - Economic effectiveness
 - Eco-efficiency
 - Ecological compatibility
 - Ergonomy
 - Societal compatibility
- The assessment is done by “scores” as we have used with the utility analysis. And – like with school grades – we accept to treat them like cardinal numbers. That way we can use the mathematical operations of addition and multiplication.

But we don't have fixed priorities or preferences between the six partial objectives. Instead, we play with weighing in order to clarify the effect of changing priorities on option ranking. The following figures are based on an example that is shown in Figure 82.

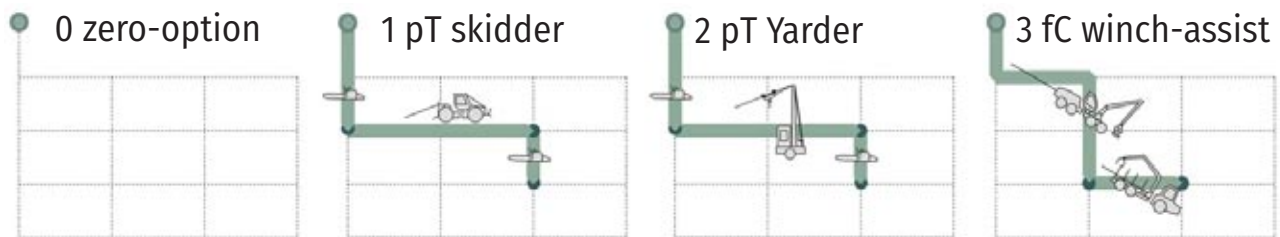

	Economic suitability		Ecological suitability		Social suitability		Utility value
option	Efficiency	Effectiveness	Eco-effic.	Ecol. comp.	Ergonom.	Soc. comp.	total
	?	?	?	?	?	?	1.00
0 zero-option	0	0	9	9	9	9	?
1 pT skidder	5	3	9	3	5	0	?
2 pT yarder	3	9	7	3	5	0	?
3 fC winch-assist	9	7	0	9	9	9	?

Figure 82: Example for target driven optimization



Equal weighting

When we weigh all three pillars equally (that means 1/3 each), we get the following optimal solutions:

- for efficiency,
 - #1 pT skidder
- for effectiveness
 - #3 fC winch-assist
- for suitability (under 50 % efficiency and 50 % effectiveness)
 - #3 fC winch-assist



		Efficiency			efficiency	
		economic efficiency	ecoefficiency	ergonomics	values	ranks
		1/3	1/3	1/3	1,00	
0	zero-opt.	0	9	9	6,00	2nd
1	pT skidder	5	9	5	6,33	1st
2	pT yarder	3	7	5	5,00	last
3	fC winch-ass.	9	0	9	6,00	2nd



		Effectiveness			efficiency	
		economic efficiency	ecoefficiency	ergonomics	values	ranks
		1/3	1/3	1/3	1,00	
0	zero-opt.	0	9	9	6,00	2nd
1	pT skidder	3	3	0	2,00	last
2	pT yarder	9	3	0	4,00	3rd
3	fC winch-ass.	7	9	9	8,33	1st



		Suitability			efficiency	
		economic efficiency	ecoefficiency	ergonomics	values	ranks
		1/3	1/3	1/3	1,00	
0	zero-opt.	0	9	9	6,00	2nd
1	pT skidder	4	6	3	4,33	last
2	pT yarder	6	5	3	4,67	3rd
3	fC winch-ass.	8	5	9	7,33	1st

Figure 83: Ranking of options under equal weighted criteria

Economic focus

When we take economy as the sole criterion (100 % weight), we get the following optimal solutions:

- for efficiency
 - #3 fC winch-assist
- for effectiveness
 - #2 pT yarder
- for suitability
 - #3 fC winch-assist



Efficiency		economic efficiency	eco-efficiency	ergonomics	efficiency values	efficiency ranks
		1	0	0	1,00	
0	zero-opt.	0	9	9	0,00	last
1	pT skidder	5	9	5	5,00	2nd
2	pT yarder	3	7	5	3,00	3rd
3	fC winch-ass.	9	0	9	9,00	1st



Effectiveness		economic efficiency	eco-efficiency	ergonomics	effectiveness values	effectiveness ranks
		1	0	0	1,00	
0	zero-opt.	0	9	9	6,00	last
1	pT skidder	3	3	0	3,00	3rd
2	pT yarder	9	3	0	9,00	1st
3	fC winch-ass.	7	9	9	7,00	2nd



Suitability (50 % effic./ 50 % effectiv.)		economic	ecological	social	suitability values	suitability ranks
		1	0	0	1,00	
0	zero-opt.	0	9	9	0,00	last
1	pT skidder	4	6	3	4,00	3rd
2	pT yarder	6	5	3	6,00	2nd
3	fC winch-ass.	8	5	9	8,00	1st

Figure 84: Example of a ranking with solely economic focus



Ecological focus

If we select ecology as the sole criterion (100 % weight), we get the following optimal solutions:

- for efficiency
 - #0 zero-option and #1 pT skidder
- for effectiveness
 - #0 zero-option and #3 fC winch-assist
- for suitability
 - #0 zero-option

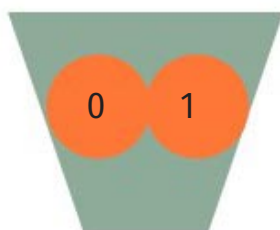

Efficiency		economic efficiency	ecoefficiency	ergonomics	efficiency values	efficiency ranks
		0	1	0	1,00	
0	zero-opt.	0	9	9	9,00	1st
1	pT skidder	5	9	5	9,00	1st
2	pT yarder	3	7	5	7,00	2nd
3	fC winch-ass.	9	0	9	0,00	last

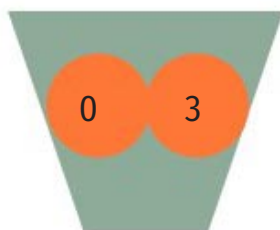

Effectiveness		economic efficiency	ecoefficiency	ergonomics	effectiveness values	effectiveness ranks
		0	1	0	1,00	
0	zero-opt.	0	9	9	9,00	1st
1	pT skidder	3	3	0	3,00	2nd
2	pT yarder	9	3	0	3,00	2nd
3	fC winch-ass.	7	9	9	9,00	1st

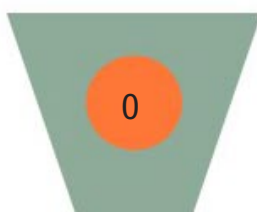

Suitability (50 % effic. / 50 % effectiv.)		economic	ecological	social	suitability values	suitability ranks
		0	1	0	1,00	
0	zero-opt.	0	9	9	9,00	last
1	pT skidder	4	6	3	6,00	3rd
2	pT yarder	6	5	3	5,00	2nd
3	fC winch-ass.	8	5	9	5,00	1st

Figure 85: The same example of a ranking as before with solely ecological focus

Social focus

And finally, if we choose social aspects as the sole criterion (100% weight), we get the following optimal solutions:

- for efficiency, effectiveness, and suitability
 - #0 zero-option and
 - #3 fC winch-assist

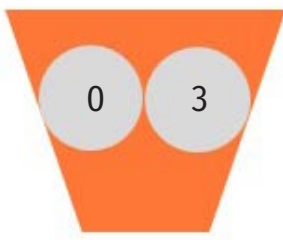

Efficiency		economic efficiency	ecoefficiency	ergonomics	efficiency values	efficiency ranks
		0	0	1	1,00	
0	zero-opt.	0	9	9	9,00	1st
1	pT skidder	5	9	5	5,00	2nd
2	pT yarder	3	7	5	5,00	2nd
3	fC winch-ass.	9	0	9	9,00	1st

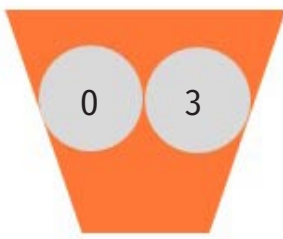

Effectiveness		economic efficiency	ecoefficiency	ergonomics	effectiveness values	effectiveness ranks
		0	0	1	1,00	
0	zero-opt.	0	9	9	9,00	1st
1	pT skidder	3	3	0	0,00	2nd
2	pT yarder	9	3	0	0,00	2nd
3	fC winch-ass.	7	9	9	9,00	1st

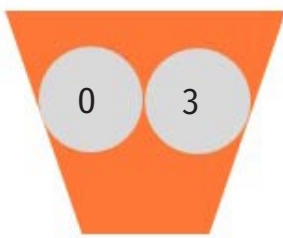

Suitability (50 % effic./ 50 % effectiv.)		economic	ecological	social	suitability values	suitability ranks
		0	0	1	1,00	
0	zero-opt.	0	9	9	9,00	1st
1	pT skidder	4	6	3	3,00	2nd
2	pT yarder	6	5	3	3,00	2nd
3	fC winch-ass.	8	5	9	9,00	1st

Figure 86: The same example of a ranking under solely social focus



The depiction with a rosette

We now see how easily the “winner” will change depending on the weights attributed to the three criteria. By introducing some finer transitions, hopefully we shall find a pattern. We will calculate these transitions with the weights as they are shown in Figure 87 and call this depiction “rosette”.

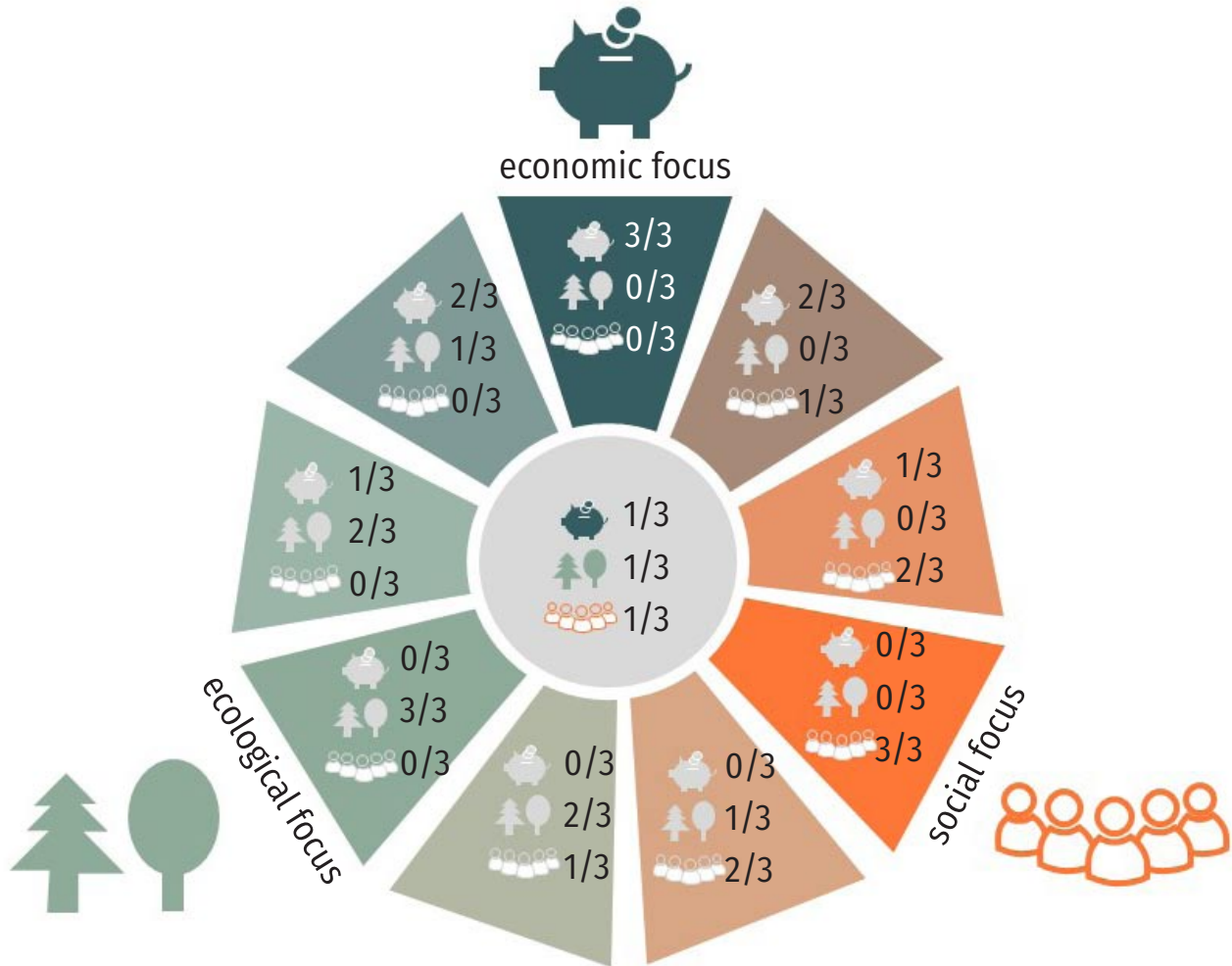

Figure 87: Basic structure of a “rosette” with sliding weights
 Like the winners that we have already found, we can calculate the other combinations in the same way with these intermediate weights.

Rosette of efficiency

For efficiency, we recognize a clear pattern:

- #0 zero-option is the winner, when we don't think at the economic dimension.
- #1 pT skidder wins, when we fade out the ergonomic disadvantages.
- #3 fC winch-assist is the best option under the economic and ergonomic views.

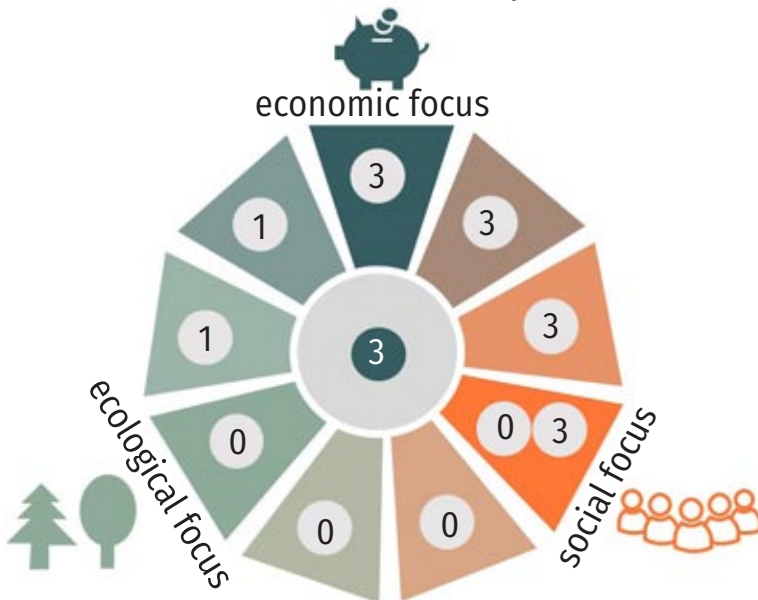

Figure 88: Same example of rating under the viewpoint of efficiency

Rosette of effectiveness

For effectiveness, things are somewhat different:

- #3 fC winch assist is nearly the overall winner.
- #0 zero-option is evaluated on a comparable level when economy is not considered.
- #2 pT yarder is the best option when we simply focus on (economic) effectiveness.

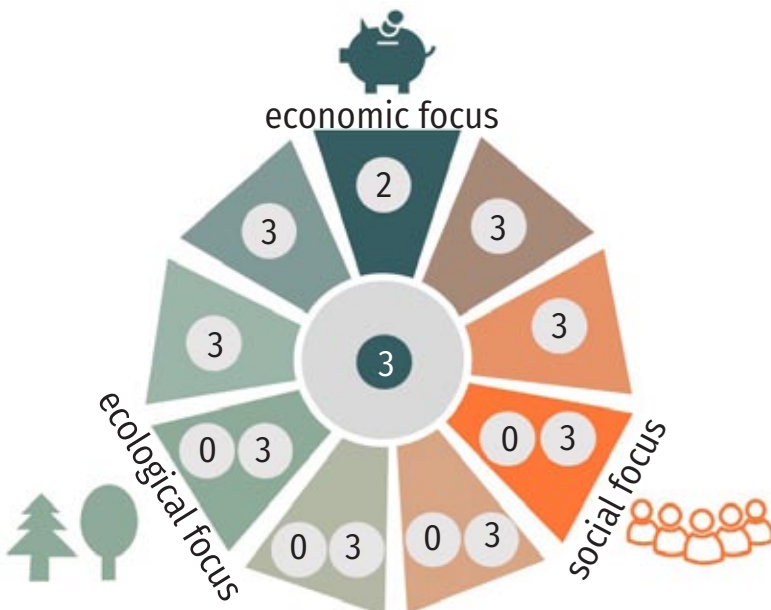

Figure 89: Same example of rating under the viewpoint of effectiveness



Rosette of suitability

To combine efficiency and effectiveness, we weight both with 50 % each. The result is fine for suitability:

- #3 fC winch assist is the best option when economy or societal aspects play a role.
- #0 zero-option is better, when ecology comes to the fore.

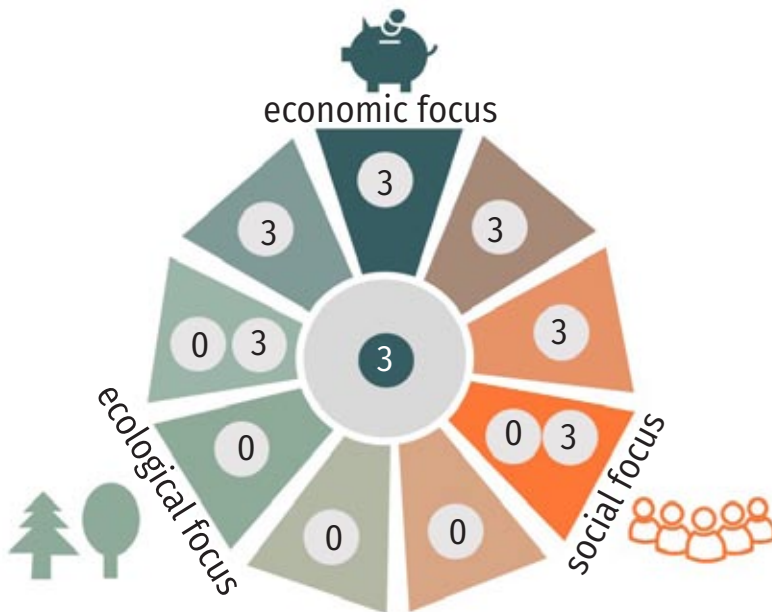

Figure 90: Same example of ranking under equal weighted efficiency and effectiveness, called suitability

Optimal areas

We can turn around the way of argumentation, too, and show under what conditions the options are best:

The zero-option is optimal under ecological and societal focus (see Figure 91).

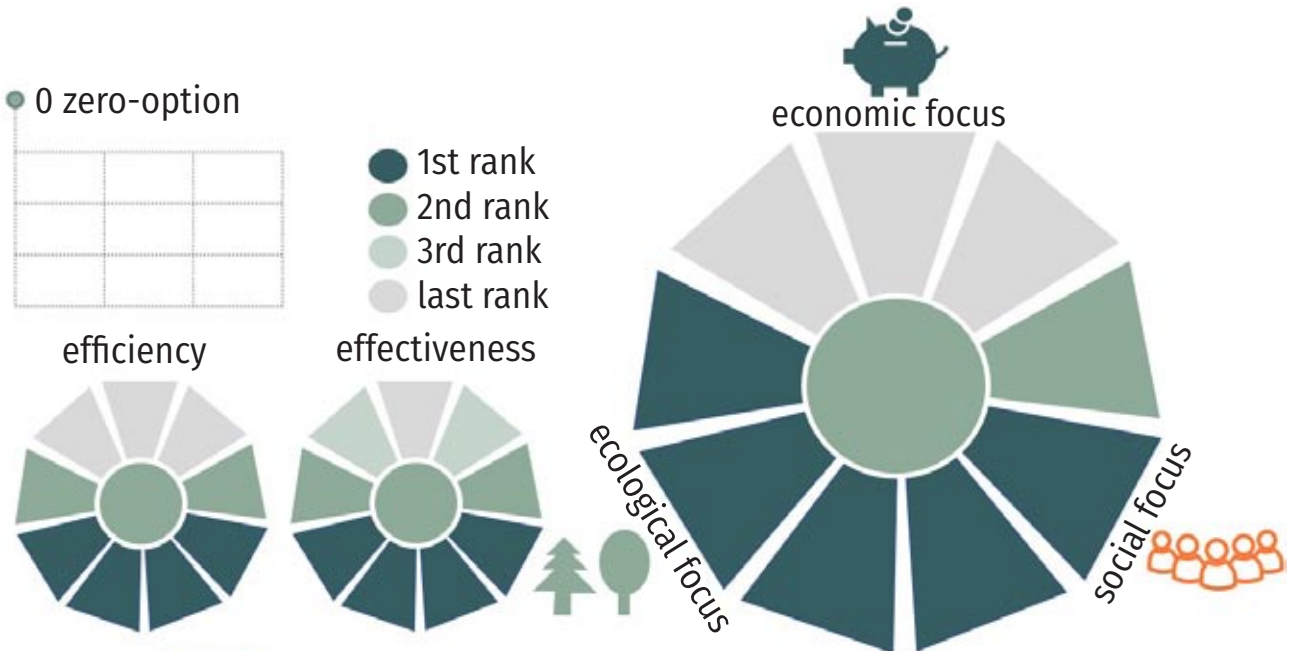

Figure 91: Same example, focus areas where the zero-option is optimal

In contrast, the fully mech. ctl-method with winch-assist system is optimal as far as ecological constraints have not any important influence.

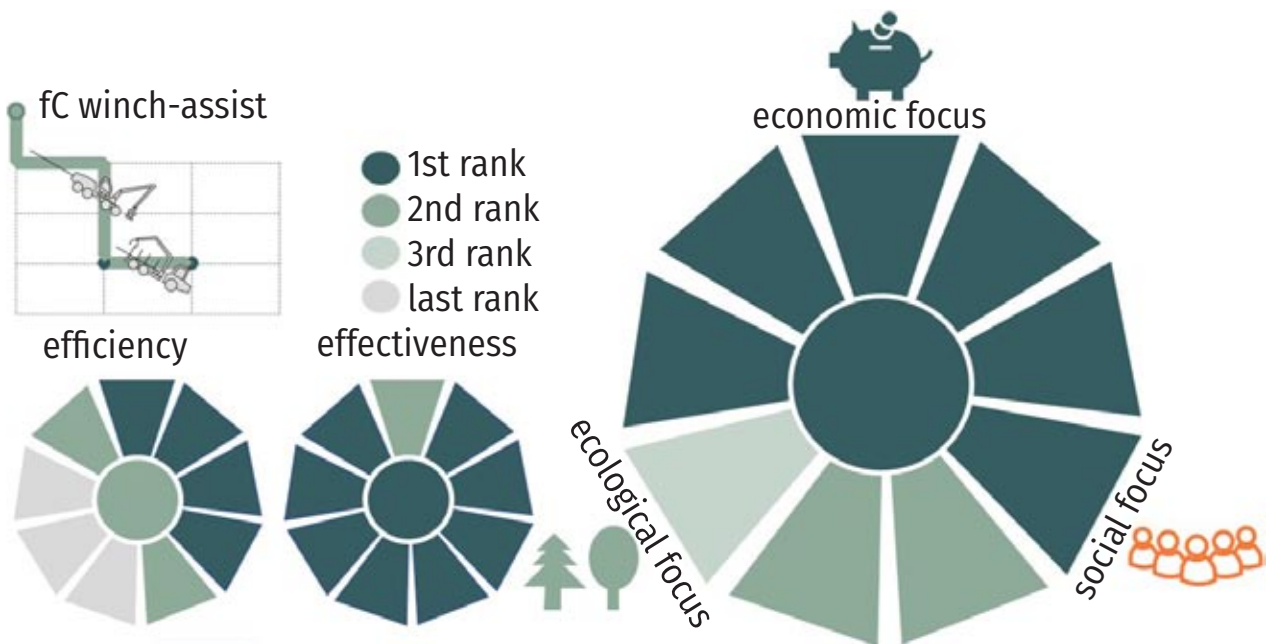

Figure 92: Same example, focus areas where the fully mechanized ctl-method with winch assist systems is optimal





G PORTRAITS OF SUB-PROCESSES

In the following pages, short profiles of sub-processes are presented. They are ordered by the numbers of the starting and ending buffers, using:

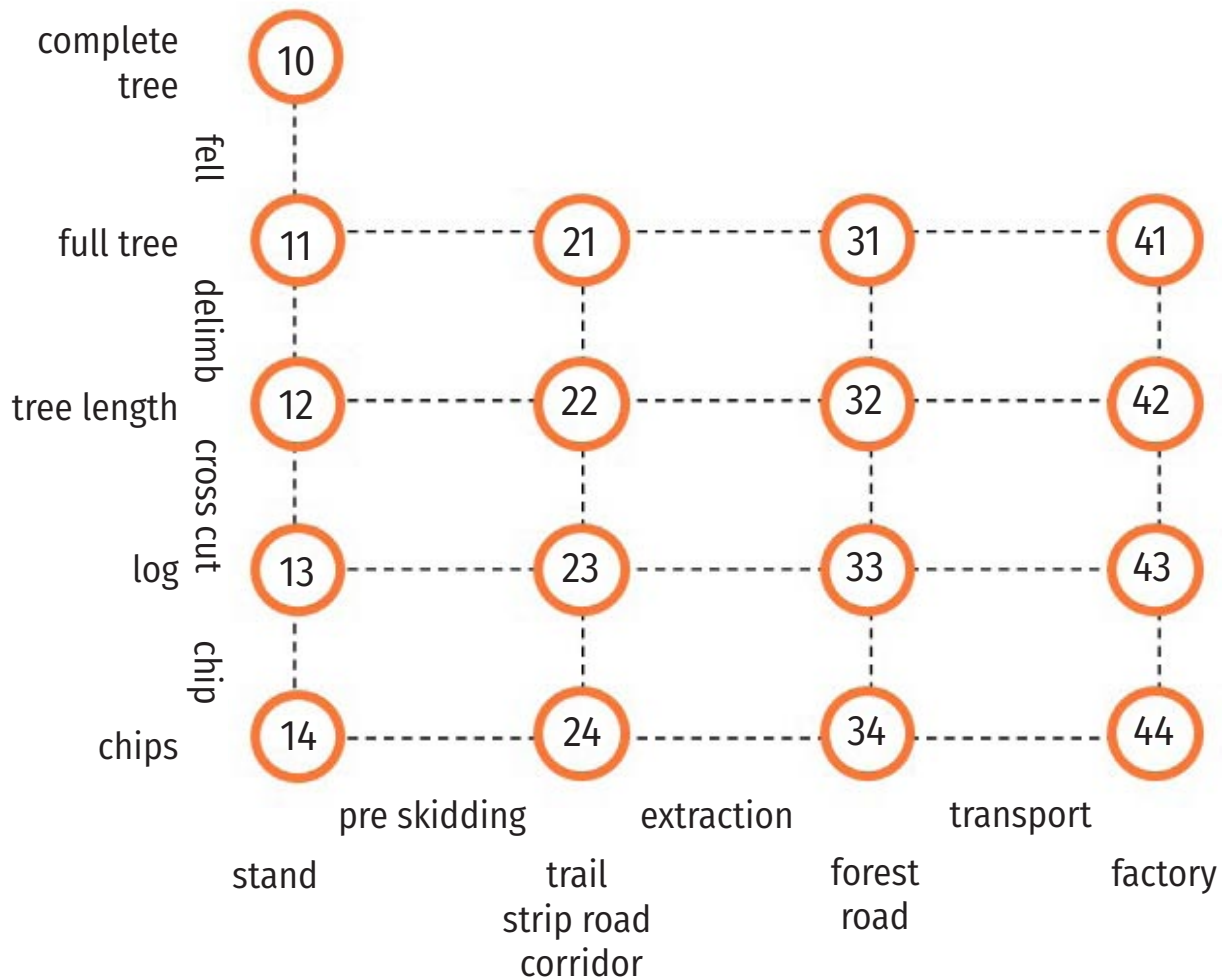
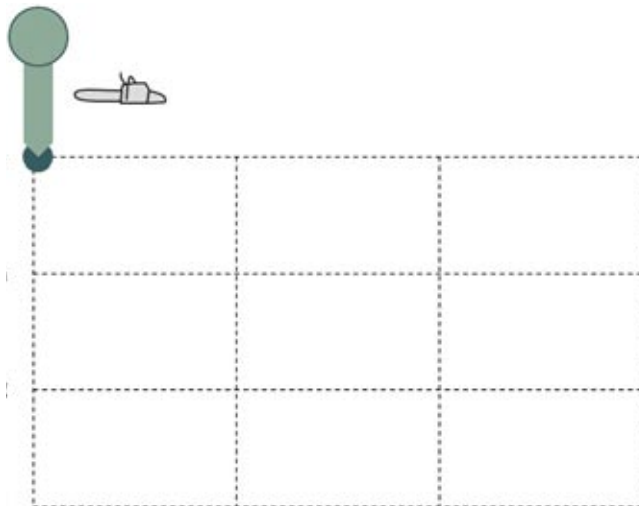

Figure 93: Nomination of the buffers in the functiogram; they are used to define the sub-processes

SP-10-11 motor-manual felling with chainsaw

Cutting tree at the base with chainsaw and fell it in a predefined pattern.

Funciogram



Advantages

- no need to relocate machines
- low investment
- accessibility to almost all terrain conditions
- no need for strip roads (unless needed by extraction vehicles)
- no tree size limitation
- higher productivity than manual work

Limitations, thresholds

- safety: motor-manual felling is very dangerous
- requires high skills
- tiresome, high strains

Main use

- thinning operations (pure selection)
- steep terrain
- broadleaved trees with higher dimensions
- wherever machine access is limited

Economic suitability

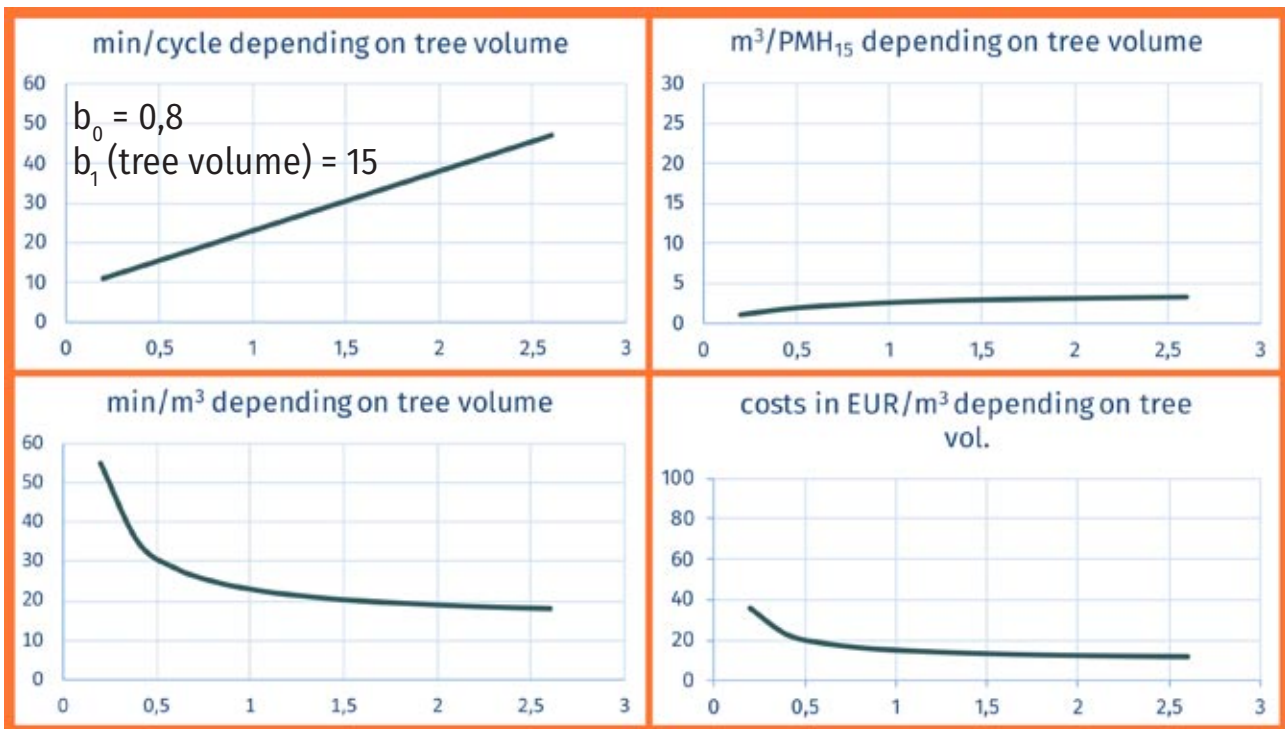

System costs (example)

- machine costs without personal costs: 4.00 Euro/h
- personal costs per person: 35.00 Euro/h
- number of persons: 1
- in total: 39.00 Euro/h

Ecological suitability

- Felling damage can occur when the forest stand is dense; depends on the education and skill of the forest worker

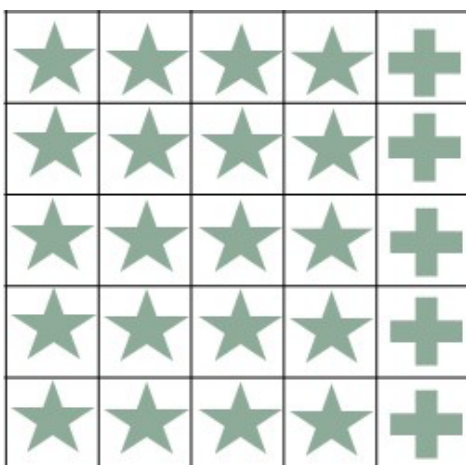

Social suitability:

- S-class: no work on forest roads > S5
- E-class: motor-manual work, very heavy and dangerous > E2

SP-10-12 motor-manual harvesting of tree length

Felling, directly followed by delimiting and topping at the predefined diameter. Important: felling direction in order to minimize the damage in stand at the pre-skidding and extraction operations

Funciogram

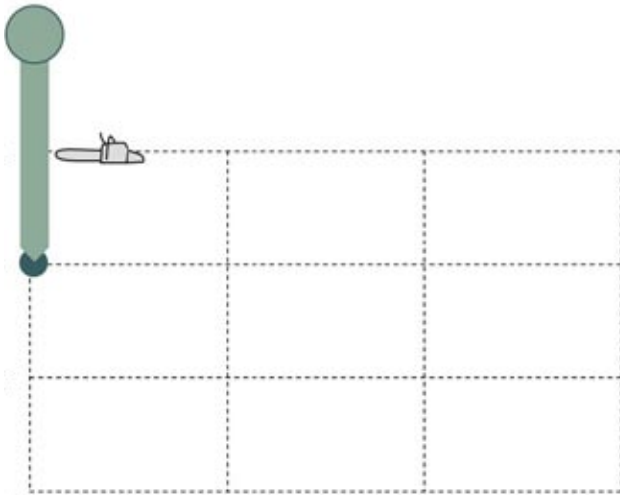

Advantages

- very flexible, nearly every tree can be processed
- no dependency on skid roads
- low investment cost
- low relocation cost

Limitations, thresholds

- high need for skills with increasing stem volume
- dangerous work
- cost with low productivity
- effort: heavy cardio-vascular workload
- need to have at least another (or other two workers) at the worksite. Cannot work alone (legal obligation in some countries, in some certification schemes, too)

Main use

- standard at sites with tree-length skidding
- broadleaved trees, tree volume too high for harvester or stand not accessible for harvester

Economic suitability

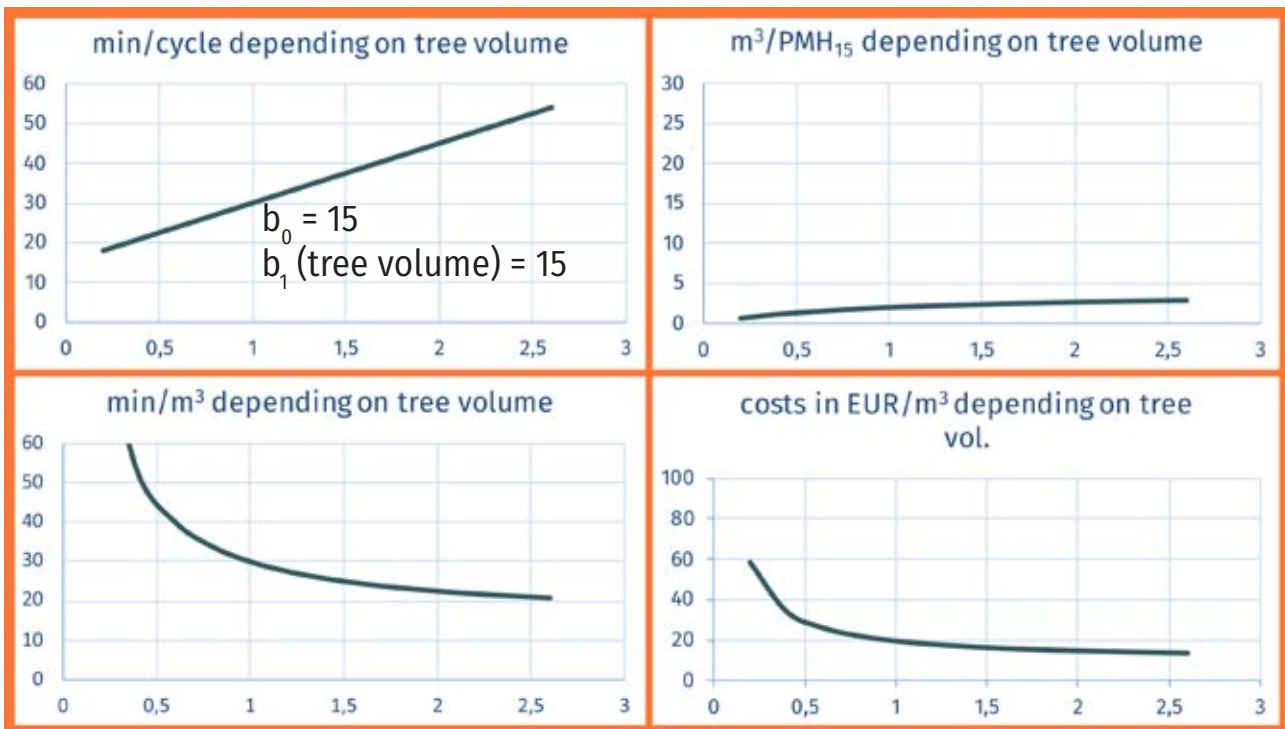

System costs (example)

- machine costs without personal costs: 4.00 Euro/h
- personal costs per person: 35.00 Euro/h
- number of persons involved: 1
- in total: 39.00 Euro/h

Ecological suitability

- Felling damage can occur when the forest stand is dense; depends on the education and skill of the forest worker

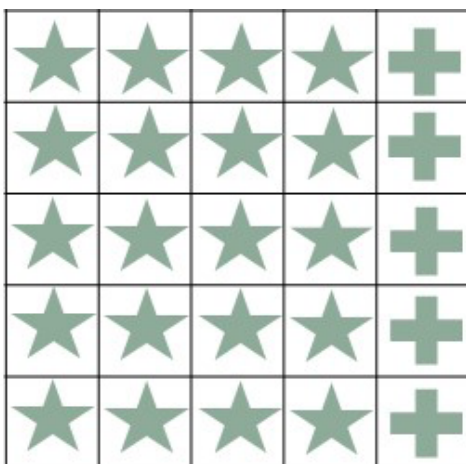

Social suitability:

- S-class: no contact with forest road > S5
- E-class: motor-manual work, very heavy and dangerous work > E2

SP-10-13 motor-manual harvesting of short logs

Felling, delimiting and bucking to standard industrial logs or differentiated assortments directly in the stand

Funciogram



Advantages

- letting nutrients and biomass in the stand
- no transport of waste
- low investment
- low relocation cost

Limitations, thresholds

- dangerous work, ergonomic limitations
- extreme danger at steep terrain
- costs of processing
- high costs of pre-skidding (logs are not bunched/stacked - follows higher cost of forwarding)

Main use

- for lowering the mass of the logs in order to ease manual pre-skidding (animal, hand)

Economic suitability

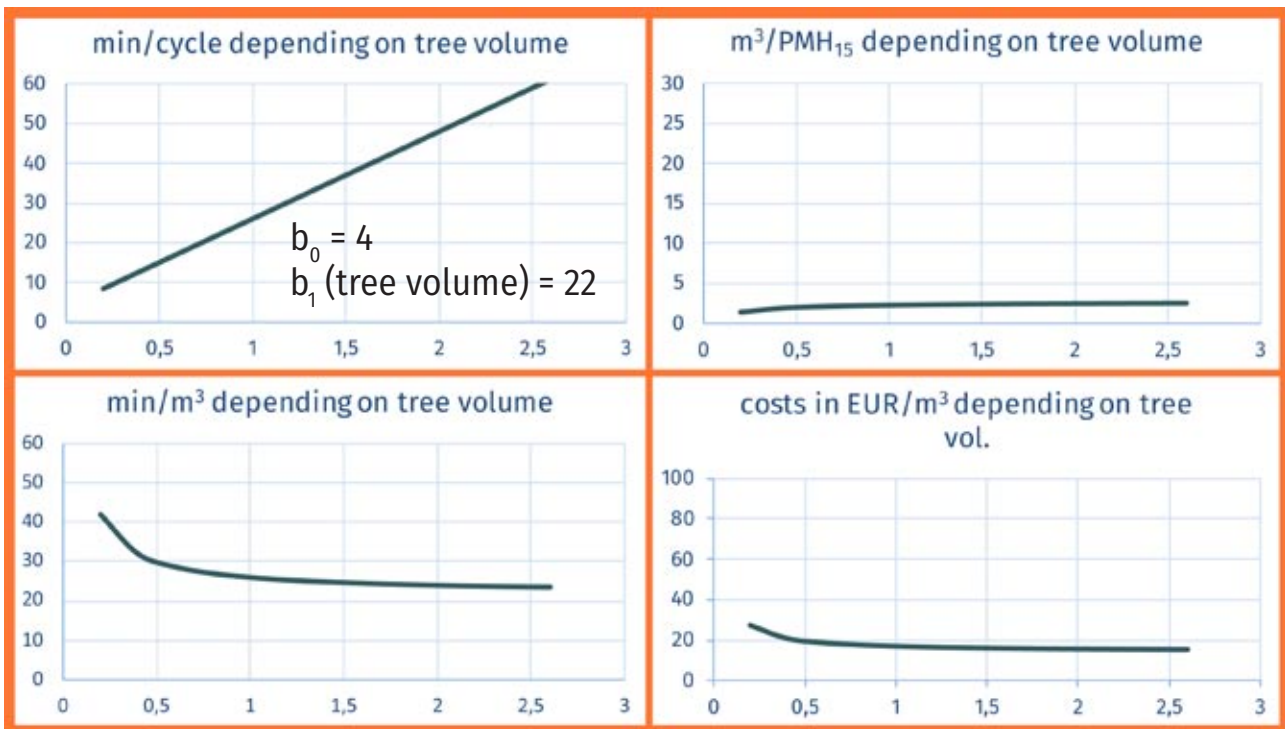

System costs (example)

- machine costs without personal costs: 4,0 Euro/h
- personal costs per person: 35,00 Euro/h
- number of persons: 1
- in total: 39,00 Euro/h

Ecological suitability

- Felling damage can occur when the forest stand is dense; depends on the education and skill of the forest worker

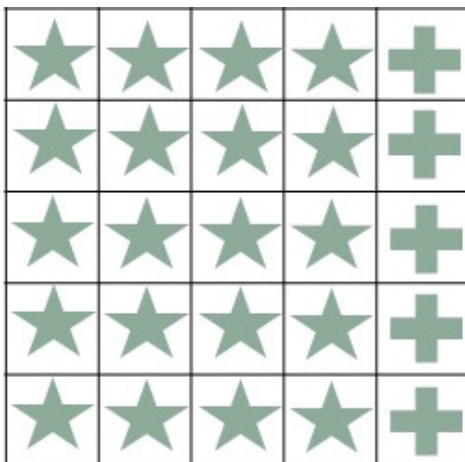

Social suitability:

- S-class: no contact with forest road > S5
- E-class: motor-manual work, very heavy and dangerous > E2

SP-10-21 mechanized felling with a feller

Only felling as a preparation for processing on accessible ground or safer ground, or before grapple skidding.

If this is the only function, the machine is called feller. But a harvester can do the job as well.

Funciogram

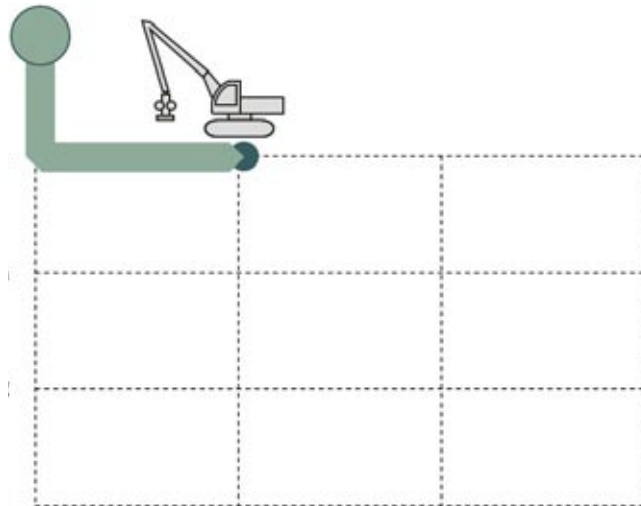

Advantages

- since it is a machine work, the driver is well protected in the cab
- only the activities that are absolutely necessary have to take place under dangerous conditions, before further activities the product is taken out of the danger zone
- bunching tree into a suitable loads and/or laying down in a orderly pattern

Limitations, thresholds

- bringing the felling head to the felling site (skid roads or driving without the limitation on the ground)
- machine accessibility to the site (needs a strip road, no pure selection)

Main use

- first cut in windthrows or on steep terrain
- biomass harvesting in thinning

Economic suitability

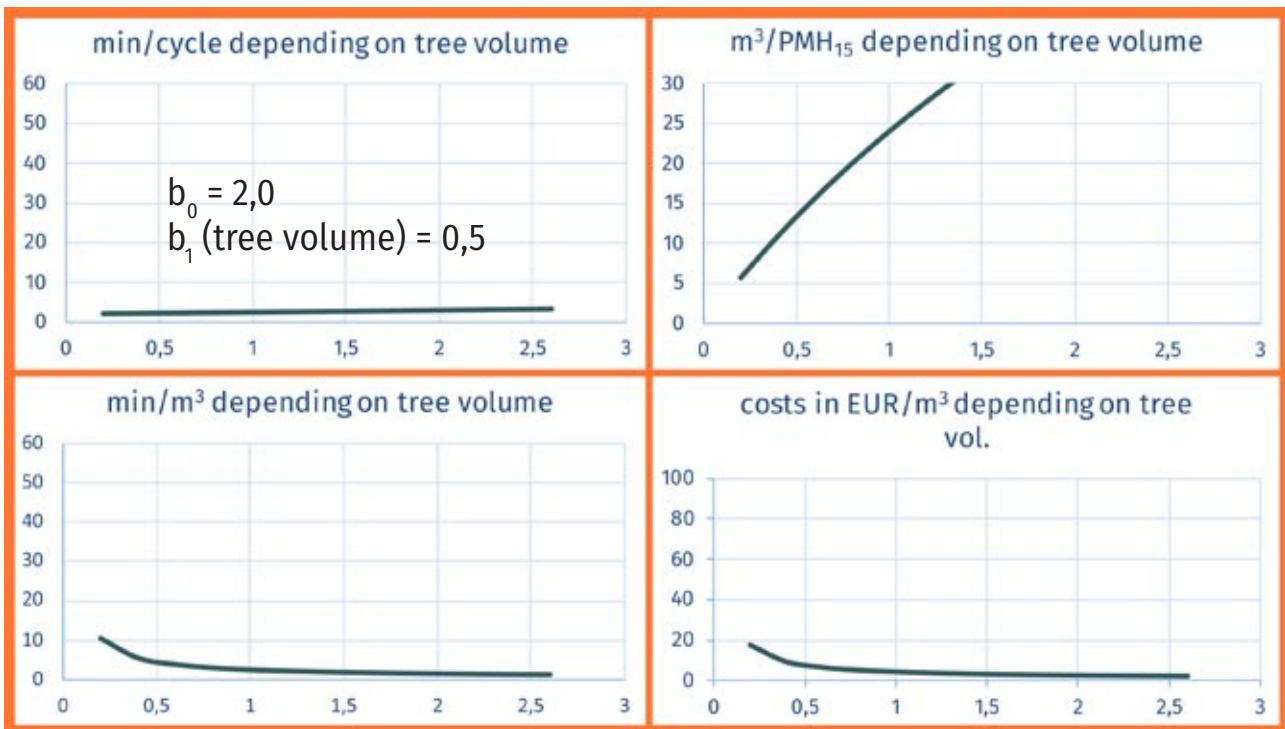

System costs (example)

- machine costs without personal costs: 65,00 Euro/h
- personal costs per person: 35,00 Euro/h
- number of persons: 1
- in total: 100,00 Euro/h

Ecological suitability

- Ecograms: bogies left without bends, right with bends

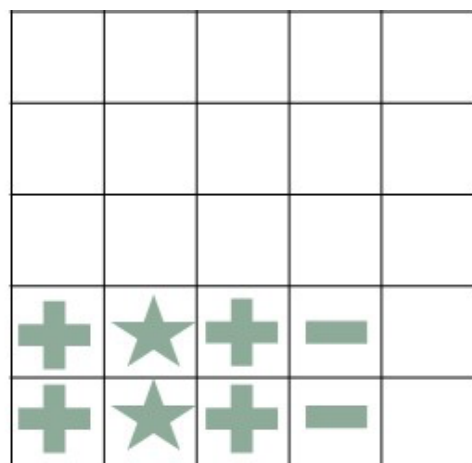
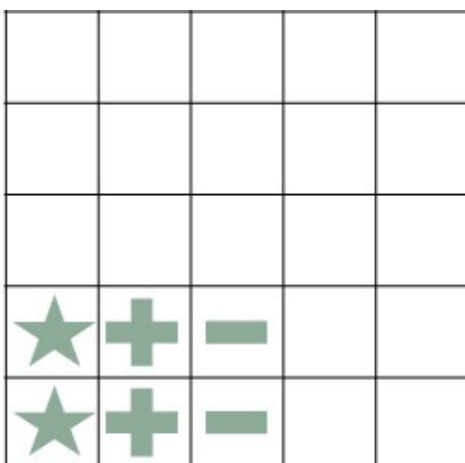

Social suitability:

- S-class: work has no contact with forest roads > S5
- E-class: advanced machine work > E4

SP-10-22 mechanized harvesting of tree length

Trees are felled and delimbed with a harvester, but are not crosscut (generally with the intention of postponing bucking at a better facility in order to maximize value recovery).

Funciogram

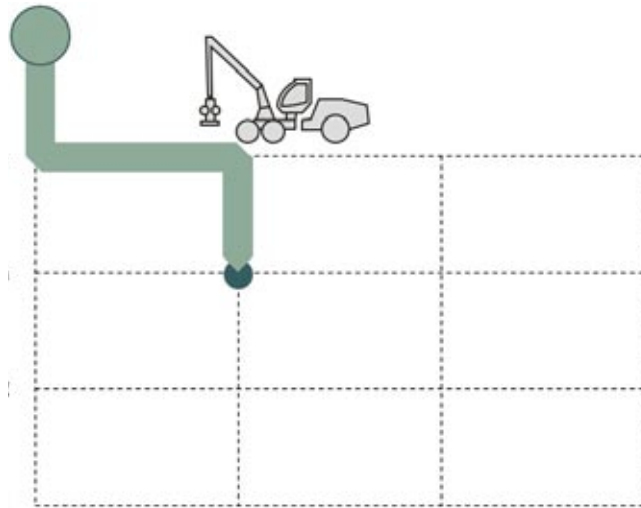

Advantages

- safer compared with motor-manual operations
- faster compared with mechanized harvesting of short logs in clearcuts
- possibility to work on ghost trails and increase distance between skid trails (where ghost trails are allowed)

Limitations, thresholds

- tree-lengths are less manoeuvrable than short logs
- higher potential for residual stand damage, esp. during subsequent extraction

Main use

- plantation forestry, often associated with the use of centralized processing yards

Economic suitability

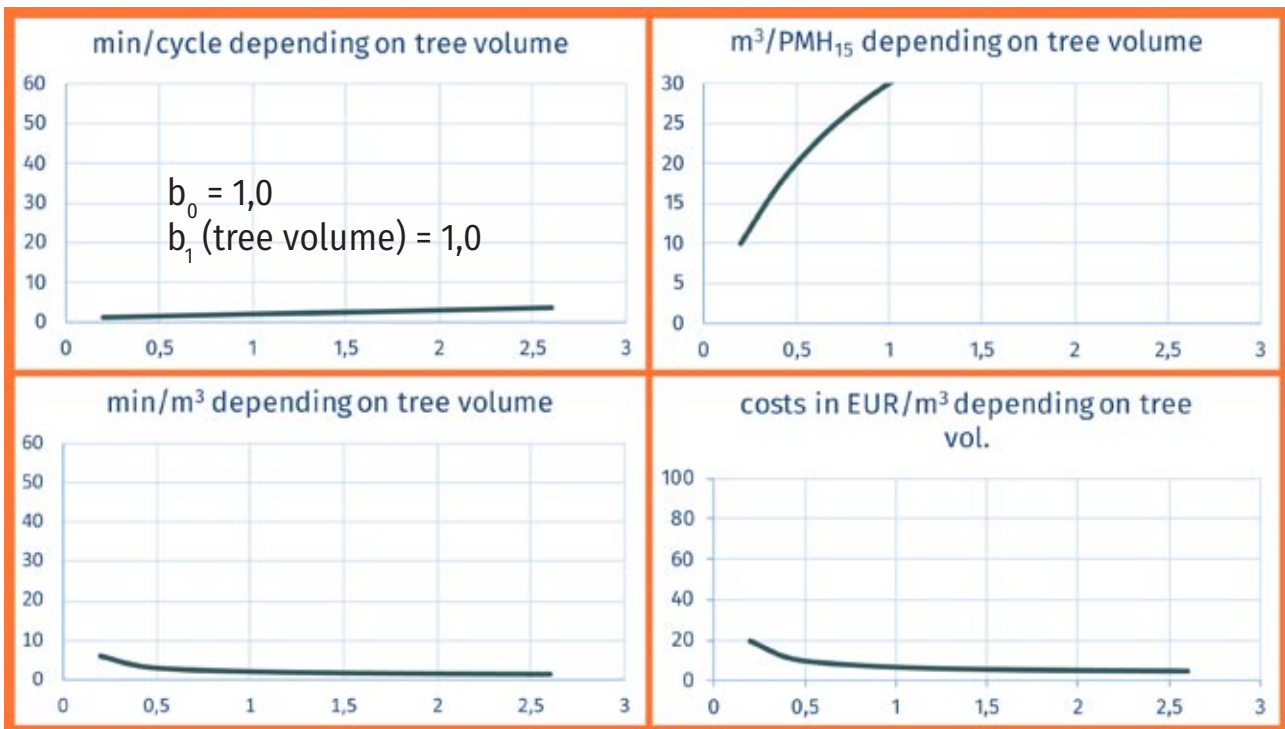

System costs (example)

- machine costs without personal costs: 160,00 Euro/h
- personal costs per person: 35,00 Euro/h
- number of persons: 1
- in total: 195,00 Euro/h

Ecological suitability

- Ecograms: bogies left without bends, right with bends

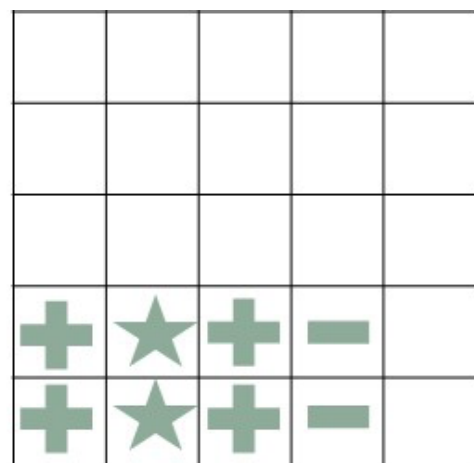
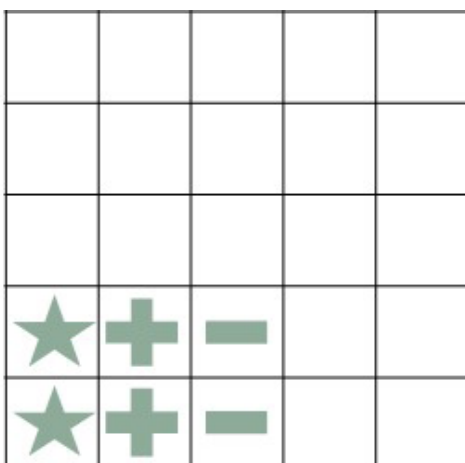

Social suitability:

- S-class: no contact with forest road > S5
- E-class: advanced machine work > E4

SP-10-23 mechanized harvesting of short logs

- harvester standing on skid road
- gripping into stand to fell tree (or in front to open up new skid road)
- pre-skid full tree by lifting the crane
- processing in front of machine, storing along skid road

Funciogram

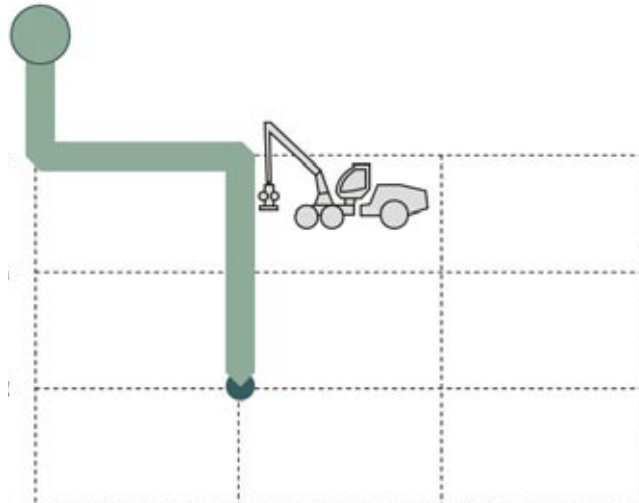

Advantages

- very highly productive
- good working site
- very low damage in stand because of upright pre-skidding and cross-cutting directly at the skid road = before the first curve has to be taken

Limitations, thresholds

- distance of skid roads not more than 2x reach of crane
- coniferous trees or younger broadleaved trees

Main use

- standard method on sites, which are accessible for wheeled machines
- with roads or with traction-line also in steep terrain

Economic suitability

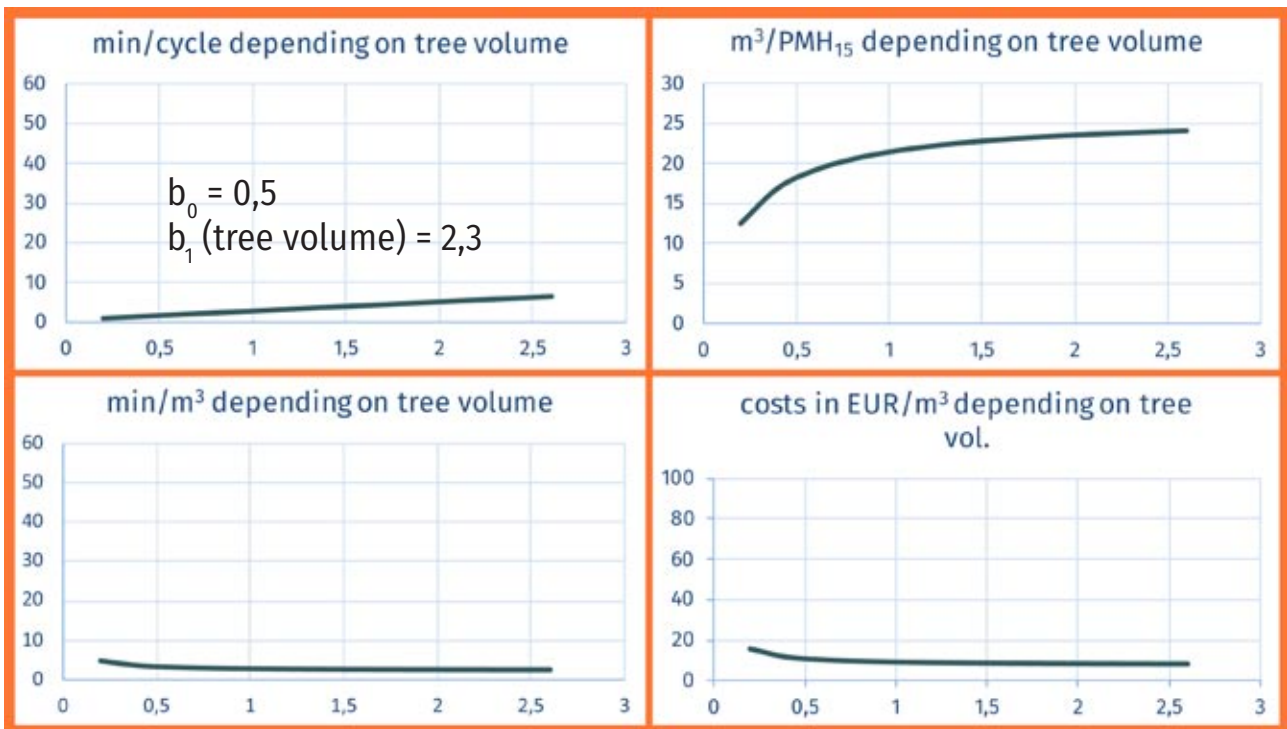

System costs (example)

- machine costs without personal costs: 160,00 Euro/h
- personal costs per person: 35,00 Euro/h
- number of persons: 1
- in total: 195,00 Euro/h

Ecological suitability

- Ecograms: bogies left without bends, right with bends

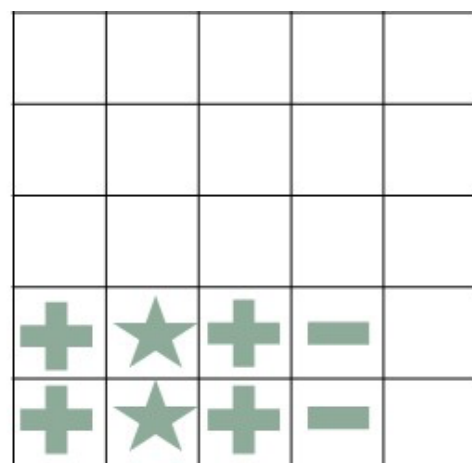
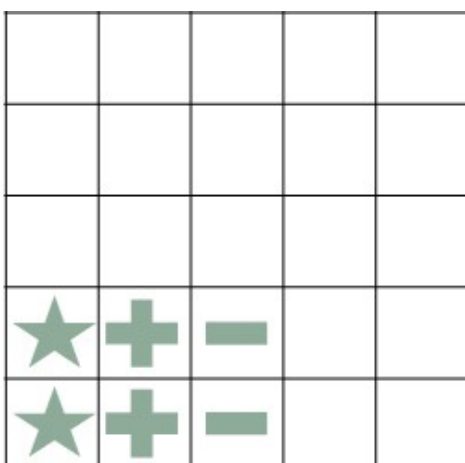

Social suitability:

- S-class: no contact with forest road > S5
- E-class: advanced machine work > E4

SP-10-33 mechanized harvesting and forwarding with harwarder

- Combination of harvester and forwarder: forwarder with harvester head at the tip of the crane
- Working like harvester, but feeding logs directly into the basket until full, then forwarding and unloading

Funciogram

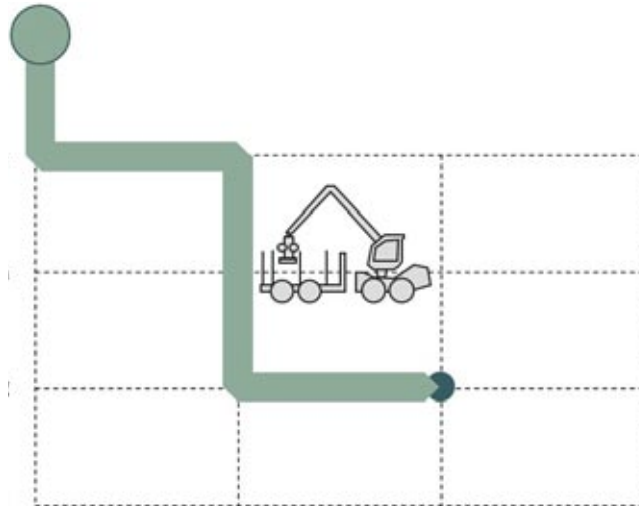

Advantages

- one machine, one driver only once is moving
- no access for the harvester – one turn less on the skid road (but harvester is not important when followed by forwarder)
- cleanest load – no contamination

Limitations, thresholds

- while processing, the forwarder is waiting, and while transporting, the heavy and expensive harvester head is in the stand-by mode
- Possible lower payload/tare ratio?

Main use

- only in areas where there is few harvesting mass (like singular windthrows, trees infested by beetles) so that machine can finish its job at the first access

Economic suitability

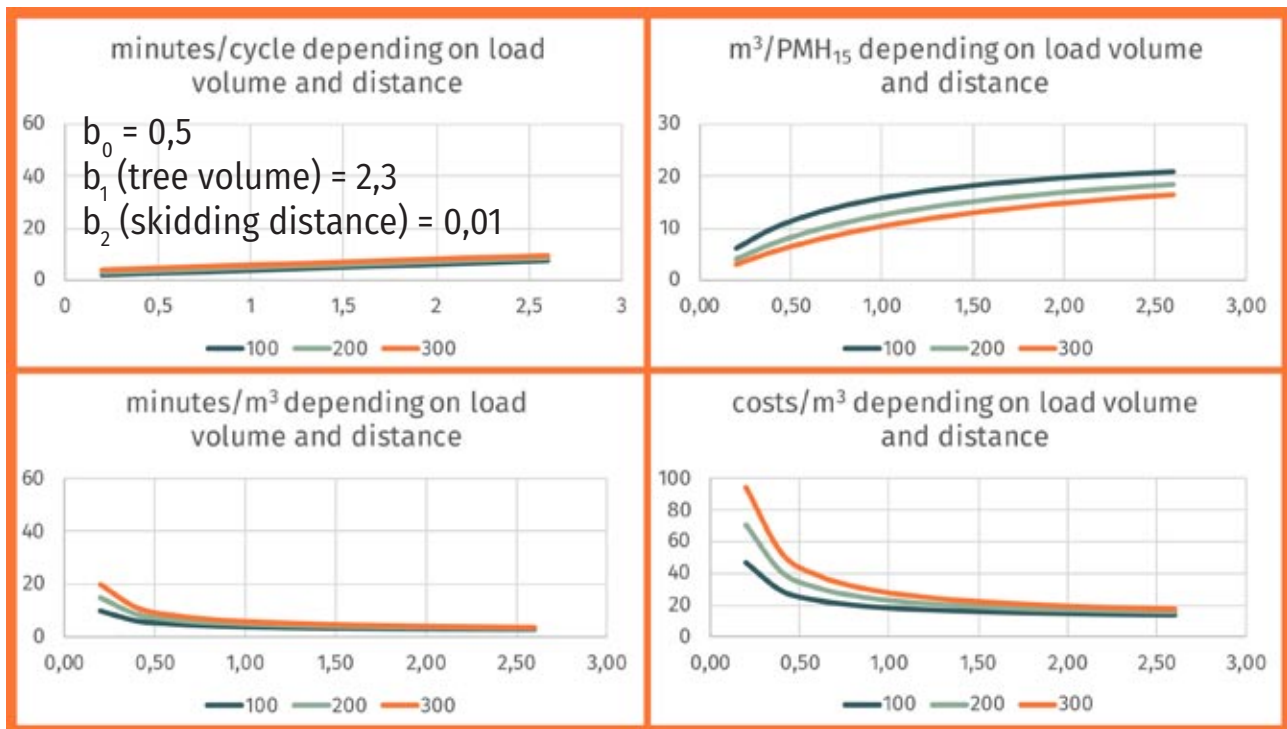

System costs (example)

- machine costs without personal costs: 250,00 Euro/h
- personal costs per person: 39,00 Euro/h
- number of persons: 1
- in total: 285,00 Euro/h

Ecological suitability

- Ecograms: bogies left without bends, right with bends

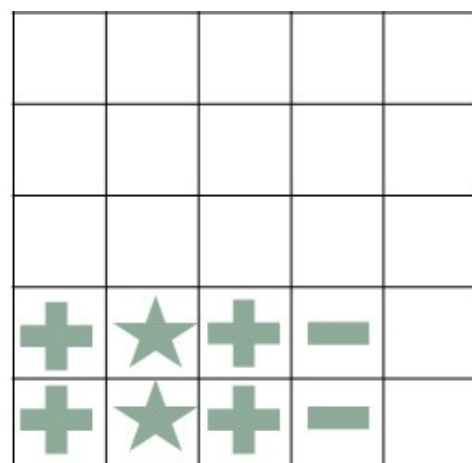
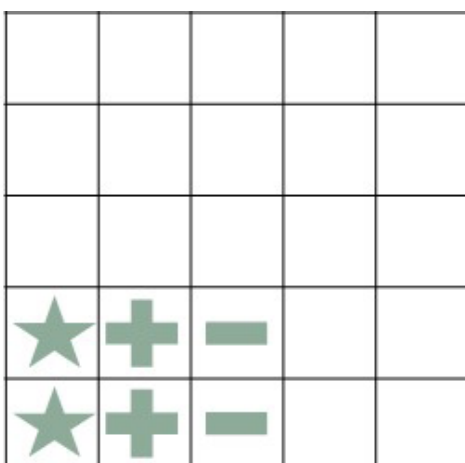

Social suitability:

- S-class: unloading of short wood at forest road > S4
- E-class: advanced machine work, moderate > E4

SP-10-34 mechanized felling and chipping with biomass harvester

One single machine cuts and chips whole trees in one single pass. This system is applied to SRC plantations and the most popular units are based on powerful (≥ 300 Kw) forwarders

Funciogram

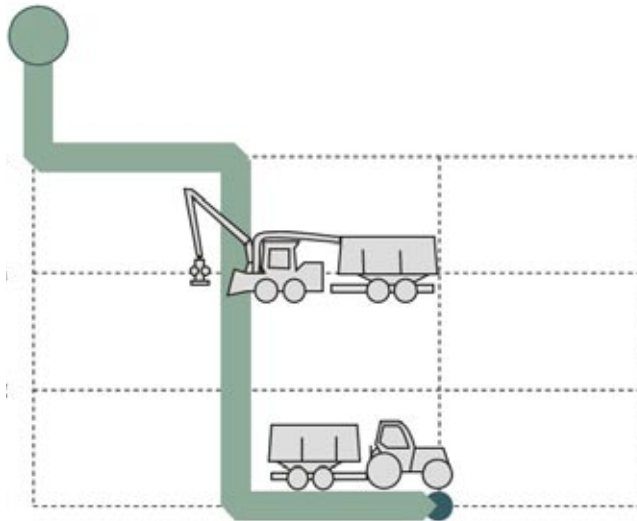

Advantages

- harvesting is simple: one single pass
- high productivity 20-35 t/h
- the base unit can be used for other tasks than SRC harvesting

Limitations, thresholds

- chips are wet and cannot be dried without an energy input (active drying) or losses (passive drying)
- requires flat terrain, solid ground
- requires that the crop is in orderly rows
- rather inflexible for stem size

Main use

- industrial SRC in ex-arable land



Economic suitability

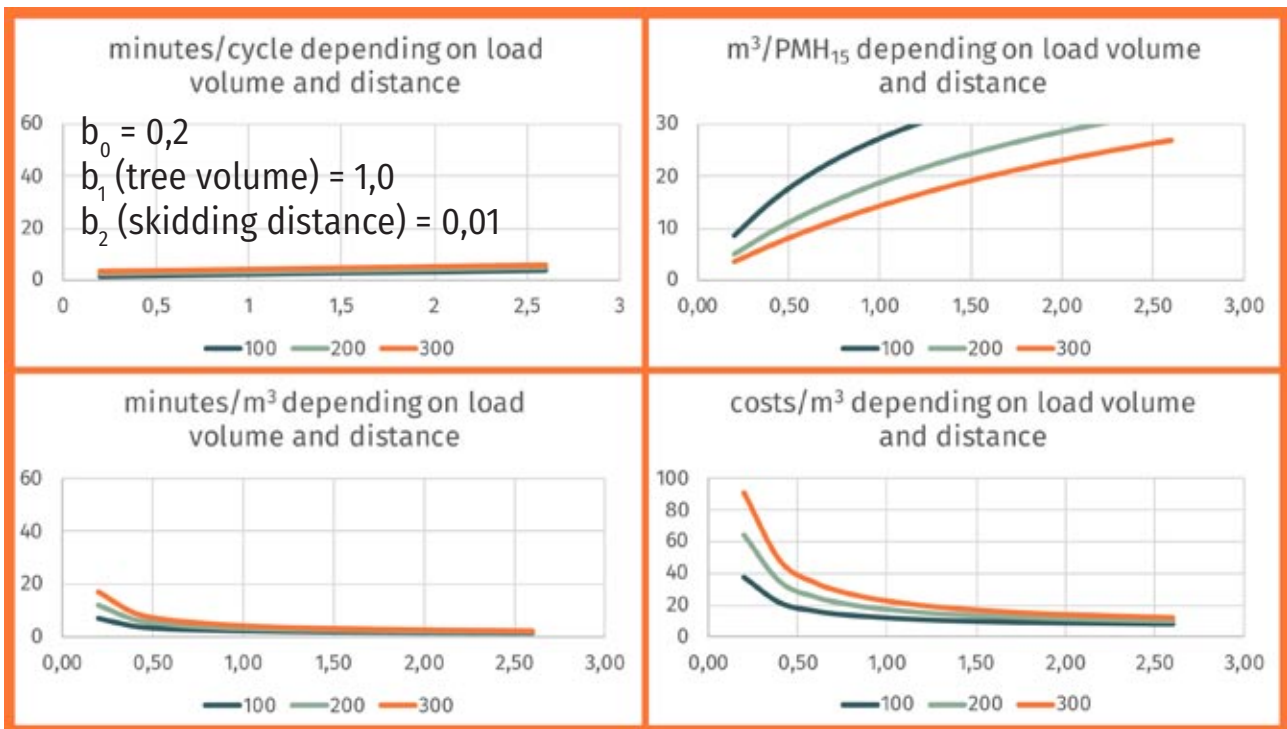

System costs (example)

- machine costs without personal costs: 250,00 Euro/h
- personal costs per person: 35,00 Euro/h
- number of persons: 2
- in total: 320,00 Euro/h

Ecological suitability

- Ecograms: bogies left without bends, right with bends

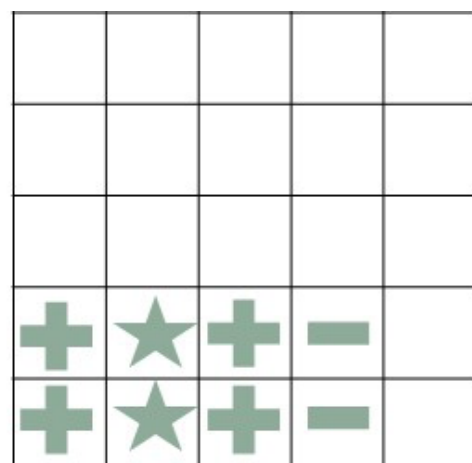
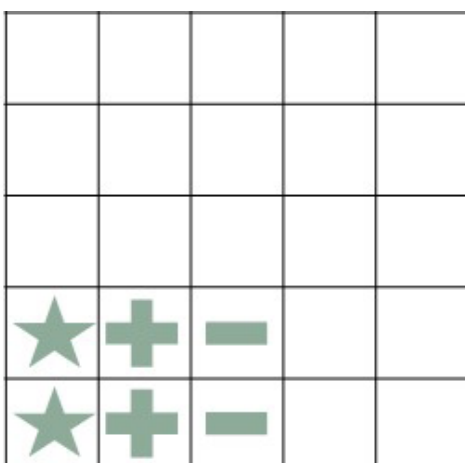

Social suitability:

- S-class: no contact with forest road > S5
- E-class: advanced machine work > E4

SP-x1-x2 manual delimiting

Limbs are to be cut by axe or comparable knives: with one cut the branch should be separated - therefore more suitable for younger trees and conifer species

Funciogram

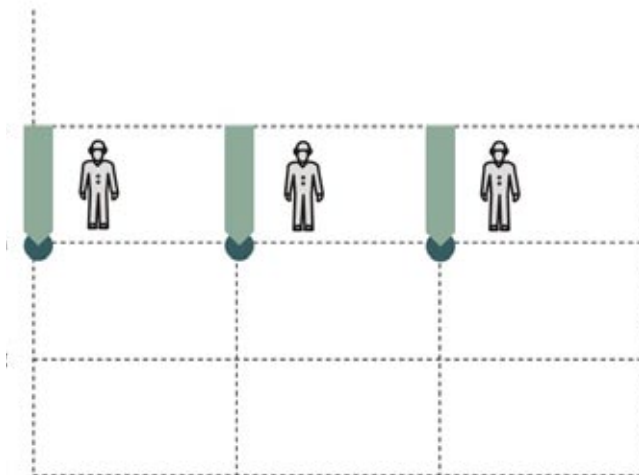

Advantages

- dynamic work as contrast to static, noisy and vibrating work with chainsaw
- easy done by workers who don't have experience with chainsaw
- low investment
- low/no relocation cost

Limitations, thresholds

- diameter of branch max 3 cm
- no. of branches, best if there are only few branches per tree
- heavy physical effort/workload

Main use

- at first thinning in regions with low wage levels

Economic suitability

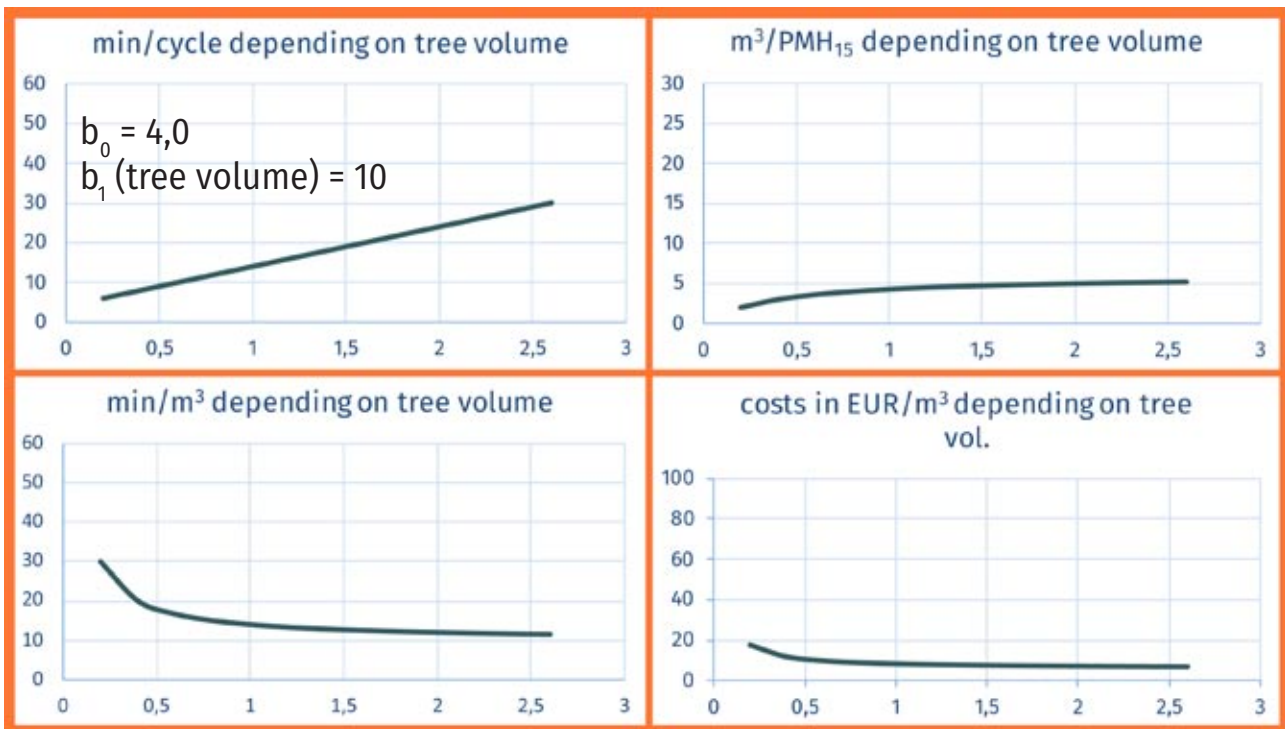

System costs (example)

- machine costs without personal costs: 0,00 Euro/h
- personal costs per person: 35,00 Euro/h
- number of persons: 1
- in total: 35,00 Euro/h

Ecological suitability

- Ecogram

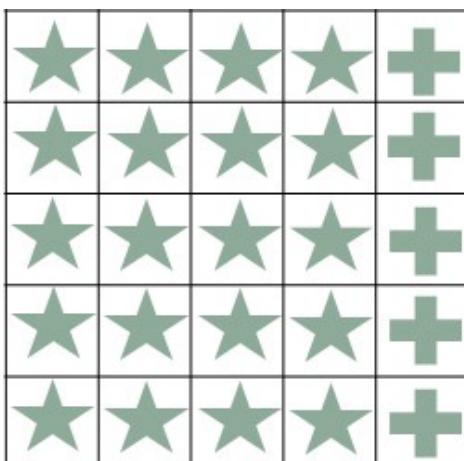

Social suitability:

- S-class: in the stand or on the trail no contact with the forest road > S5
- S-class: processing on the forest road > S2
- E-class: manual work, very heavy and dangerous > E1

SP-x1-x2 motor-manual delimiting

When the tree is felled (lays on ground) the limbs are cut from bottom to top. Three methods: two whorls at a time; whorl by whorl, and from top to the side. When finished the tree is rolled over to continue on the other side.

Funciogram

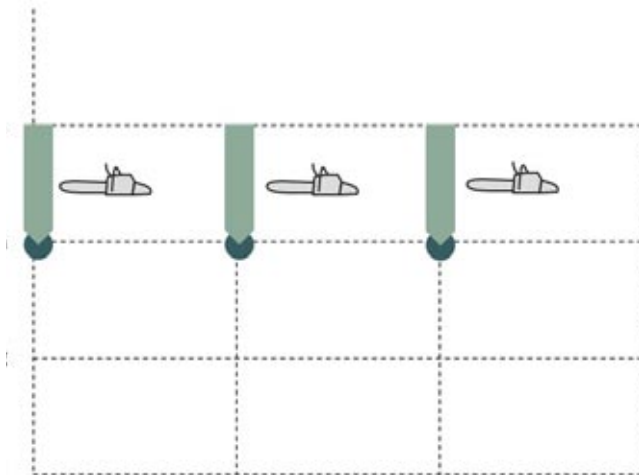

Advantages

- high efficiency
- high work quality (no risk for roller damage, flush cut of branches, better measuring under difficult stem conditions etc.)
- low investment
- low relocation cost

Limitations, thresholds

- open space for standpoint of the worker needed
- danger to hit legs and shoes with chainsaw
- danger to injure the legs and feet
- static strain on backbone
- heavy effort/cardio workload
- low productivity

Main use

- delimiting broadleaved trees
- delimiting conifer trees where no processor/harvester is able to do a good job

Economic suitability

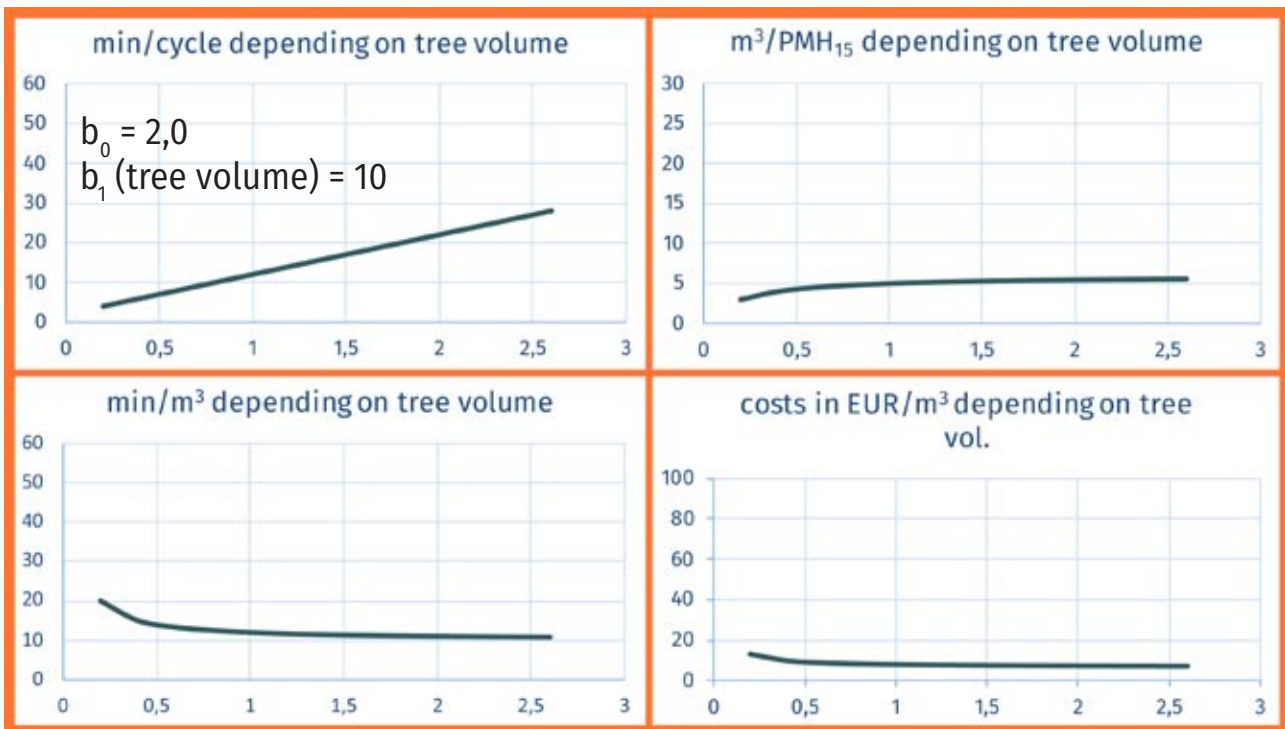

System costs (example)

- machine costs without personal costs: 4,00 Euro/h
- personal costs per person: 35,00 Euro/h
- number of persons: 1
- in total: 39,00 Euro/h

Ecological suitability

- Ecogram

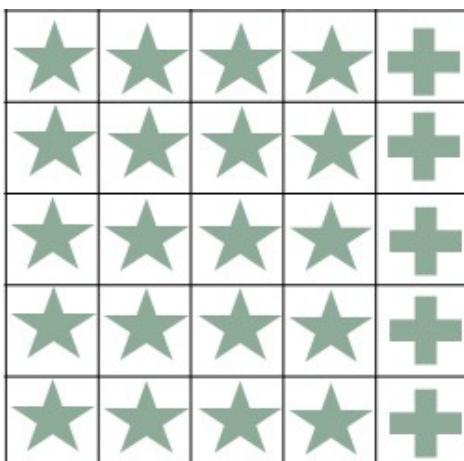

Social suitability:

- S-class: in the stand or on the trail no contact with the forest road > S5
- S-class: processing on the forest road > S2
- E-class: manual work, very heavy and dangerous > E1

SP-11-21 pre-skidding of full trees with animals

After felling, trees are pre-skidded to a strip road using animals, and most commonly draught horses. Different breeds are available in different regions, but the most popular are heavy breeds like French Percherons, Belgian Ardennes, or Italian TPR.

Funciogram

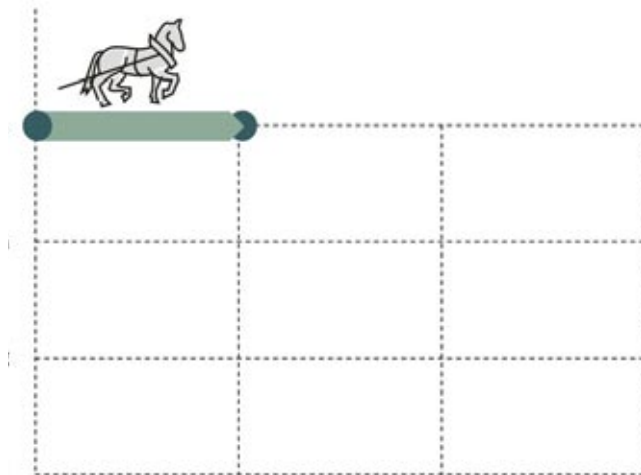

Advantages

- able to work in dense stands that are too narrow for machines
- some species are capable to work on steep terrain
- very low soil and stand impacts
- comfort for the operator due to low stress from the work itself

Limitations, thresholds

- system is suitable for young trees only, as obtained from first and second thinnings, or to coppice harvesting operations.
- distance must not exceed 200 m. Best results are obtained on shorter distances, between 25 and 100 m.
- extraction must proceed on flat terrain or downhill slopes, with a maximum gradient of 50%
- draught animals can only work 5 to 6 hours a day.

Main use

- animal pre-skidding is rarely used in industrialized countries, where it remains a specialist niche. The reason is in the small numbers of horse loggers, ready to accept the constant commitment imposed by animal care.

Economic suitability

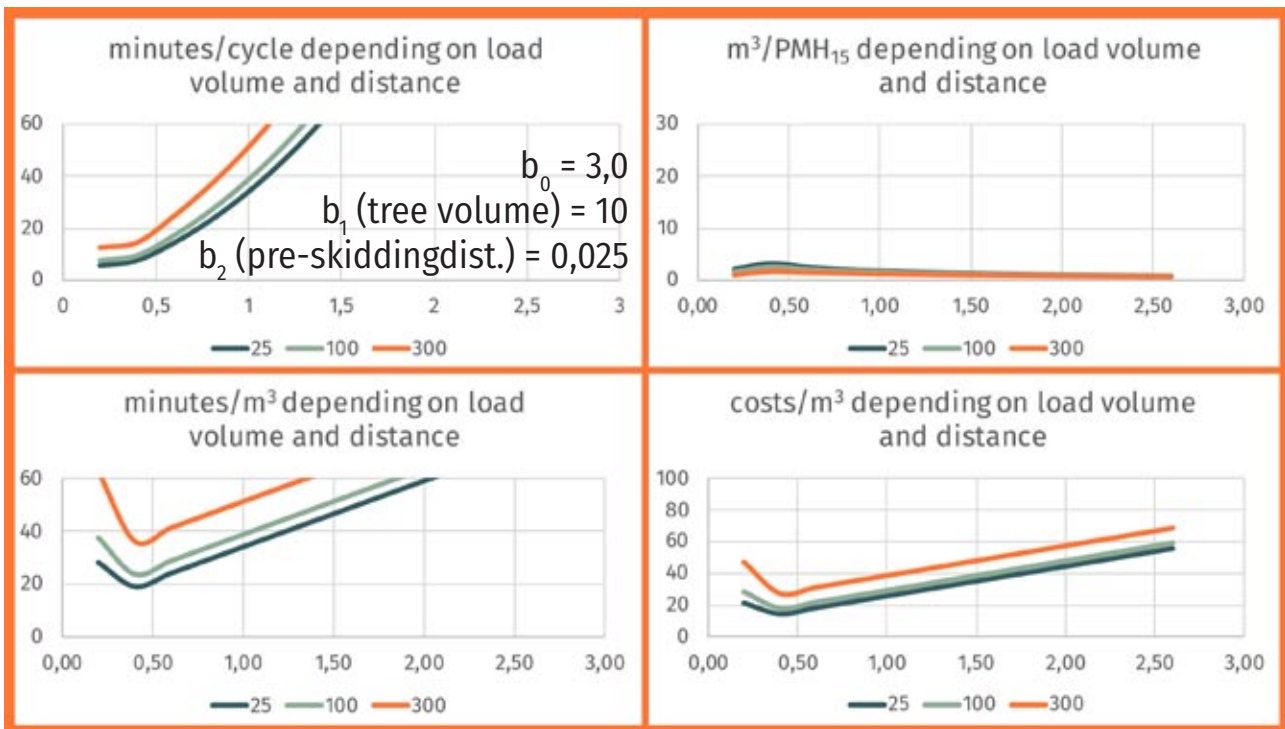

System costs (example)

- system costs without personal costs: 10,00 Euro/h
- personal costs per person: 35,00 Euro/h
- number of persons: 1
- in total: 45,00 Euro/h
- cross-cutting if volume/tree exceeds 0,3 m³

Ecological suitability

★	★	+	-	
★	★	+	-	

Social suitability:

- S-class: no contact with forest road > S5
- E-class: very heavy and dangerous manual work > E1

SP-11-21 pre-skidding of full trees with tractor winch

Pre-skidding of full trees from the felling site to the strip road with a winch that is mounted or attached to a tractor.

Since winch pre-skidding is extremely sensitive to distance, it should be used on very short distances, only. If tree volume is large enough, then one can obtain acceptable results also on medium distances, up to 50 m.

Funciogram

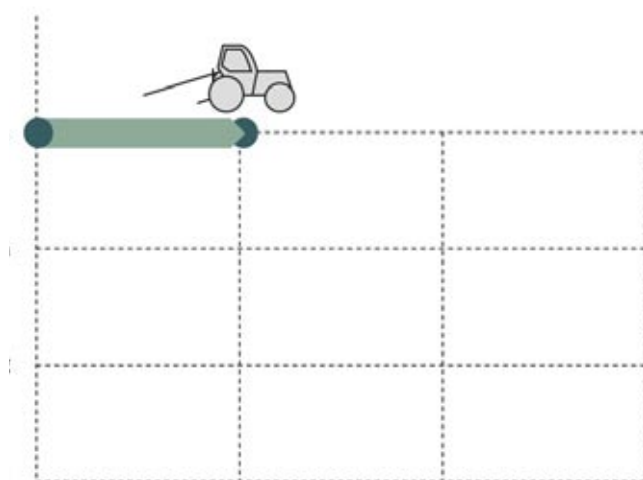

Advantages

- extraction over long distance without driving on the ground
- extracting in steep terrain (uphill)
- bringing trees to a site where machines for delimiting and cross-cutting can operate

Limitations, thresholds

- distance limited by the length of the cable, often mostly up-to 100 m
- distance limited by the weight of the cable that must be pulled by the worker, so on flat terrain not more than 50 m, downhill wider distances are possible
- cable cannot be pulled uphill, therefore no downhill extraction over long steep terrain

Main use

- in stands where fully mechanized methods are not applicable due to ground conditions, tree species (large broadleaved trees)
- with wider distance between trails, where trees must be pulled into the reach of the crane of a machine
- in combination with extraction by means of a tractor

Economic suitability

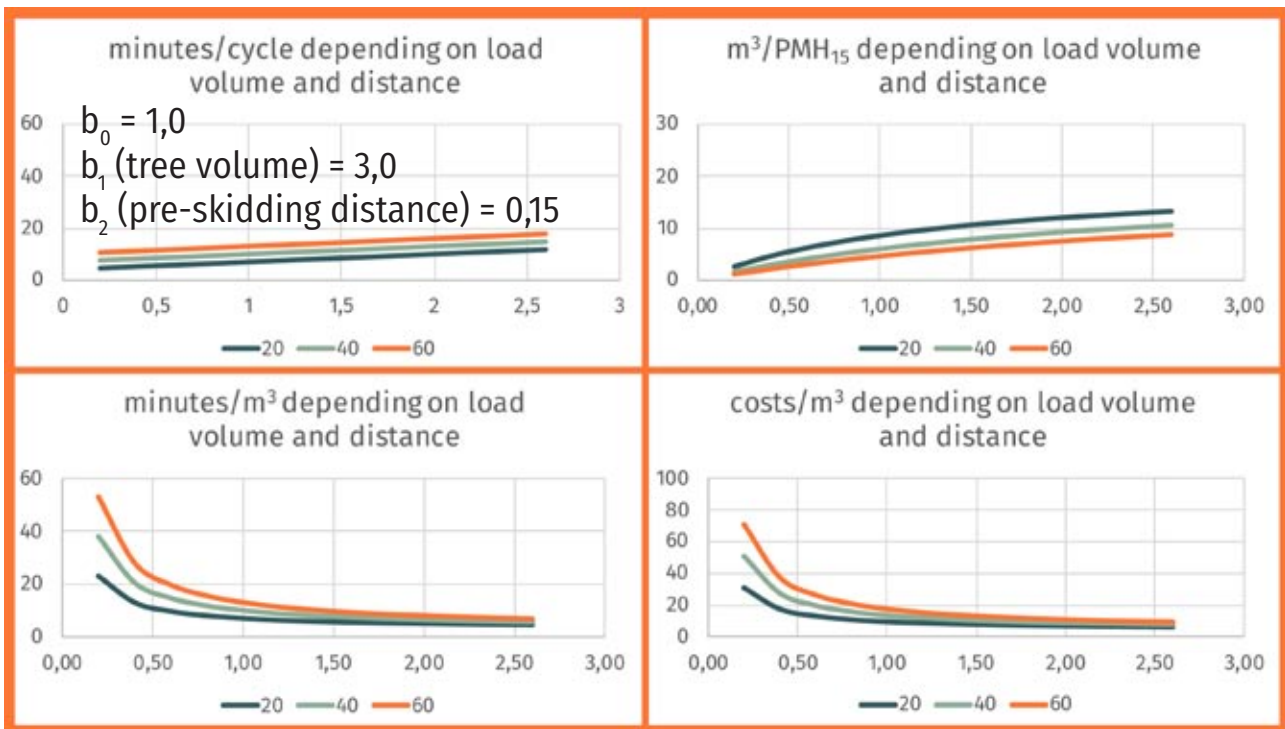

System costs (example)

- machine costs without personal costs: 10,00 Euro/h
- personal costs per person: 35,00 Euro/h
- number of persons: 2
- in total: 80,00 Euro/h

Ecological suitability

- Ecograms: wheels left without traction chains, right with traction chains

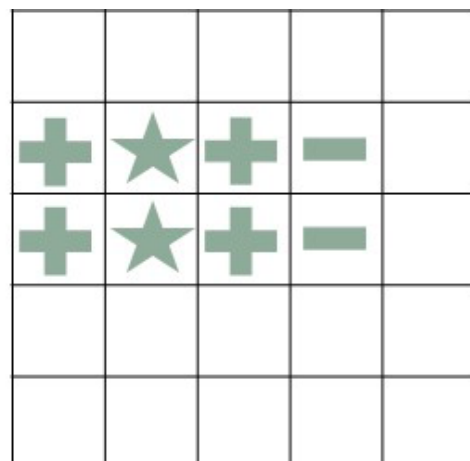
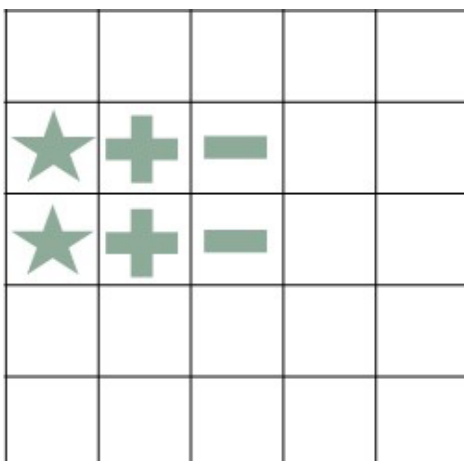

Social suitability:

- S-class: no contact with forest road > S5
- E-class: simple machine work, heavy and dangerous > E3

SP-11-31 pre-skidding and skidding of full trees with a tractor

Felled trees are pulled to a trail by means of a tractor winch; when some full trees are collected, the tractor extracts them to the forest road and unloads alongside the road.

Funciogram

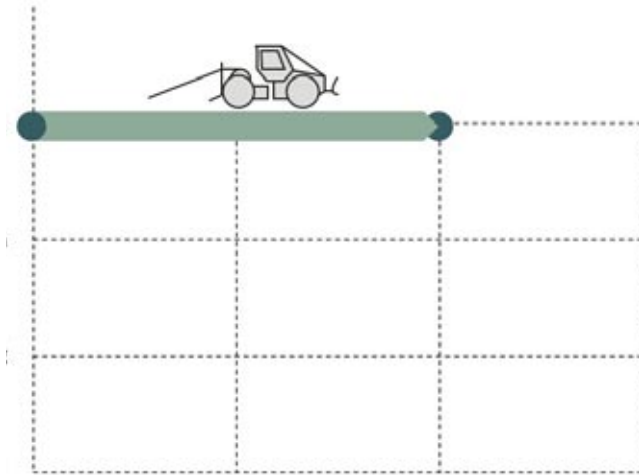

Advantages

- due to the cable, the area from which full trees can be extracted, is large
- capable for steep terrain (pre-skidding uphill)

Limitations, thresholds

- extraction length of the cable limited by the human power, maximum 50 m
- damage caused by the full trees

Main use

- small scale forestry with own tractors

Economic suitability

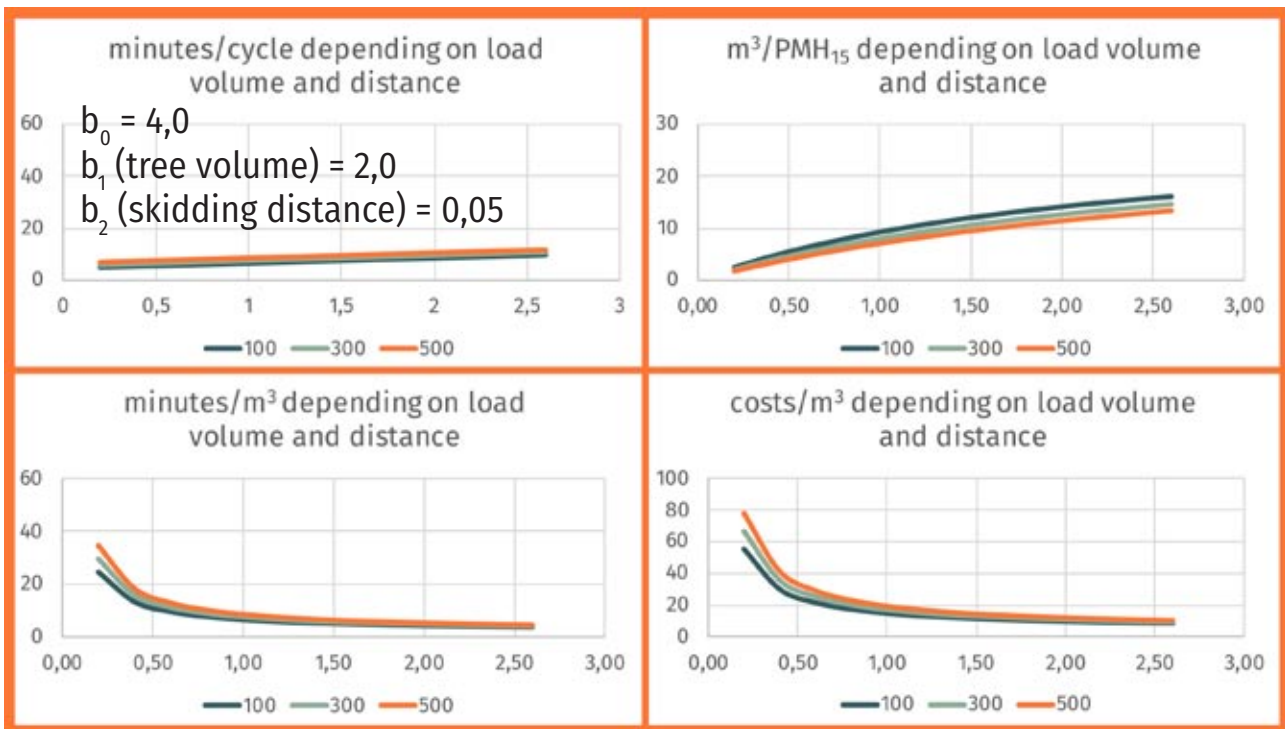

System costs (example)

- machine costs without personal costs: 65,00 Euro/h
- personal costs per person: 35,00 Euro/h
- number of persons: 2
- in total: 135,00 Euro/h

Ecological suitability

- Ecograms: wheels left without traction chains, right with traction chains

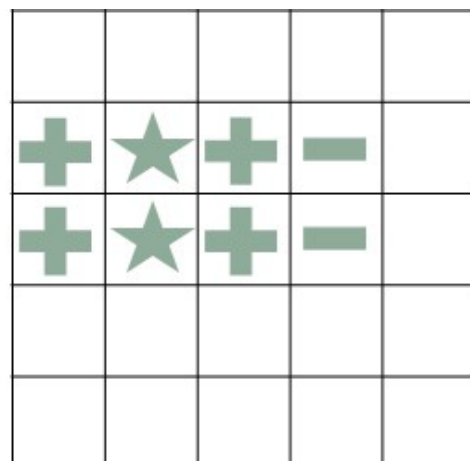
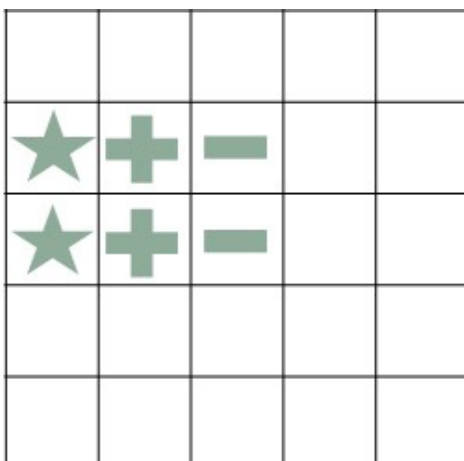

Social suitability:

- S-class: unloading full trees on forest road > S3
- E-class: simple machine work, heavy and dangerous > E3

SP-11-31 pre-skidding and skidding of full trees with yarder

Full trees are moved to a landing (roadside landing, landing pad etc.) suspended under a carriage that runs on a cable (skyline). In a certain distance, trees can be pulled from the sides to the skyline.

Different types and configurations are available (live, standing, running skyline, self-propelled carriage, swing yarders – carriages with cable or grapple).

Funciogram

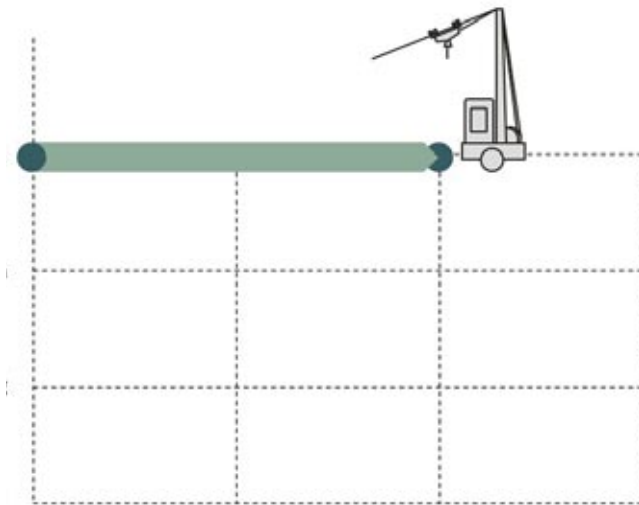

Advantages

- capable of working in steep terrain
- less soil disturbance than for ground-based
- capable of pre-skidding loads (drop line)
- can work with limited road network

Limitations, thresholds

- relatively long set-up and dismantle time
- because the time for set-up and dismantle of the skyline is high, the volume that is extracted by it must be high
- high planning effort
- requires high operator skill

Main use

- mountain operations
- alpine forestry
- on soft terrain as reduced-impact alternative to ground-based extraction

Economic suitability

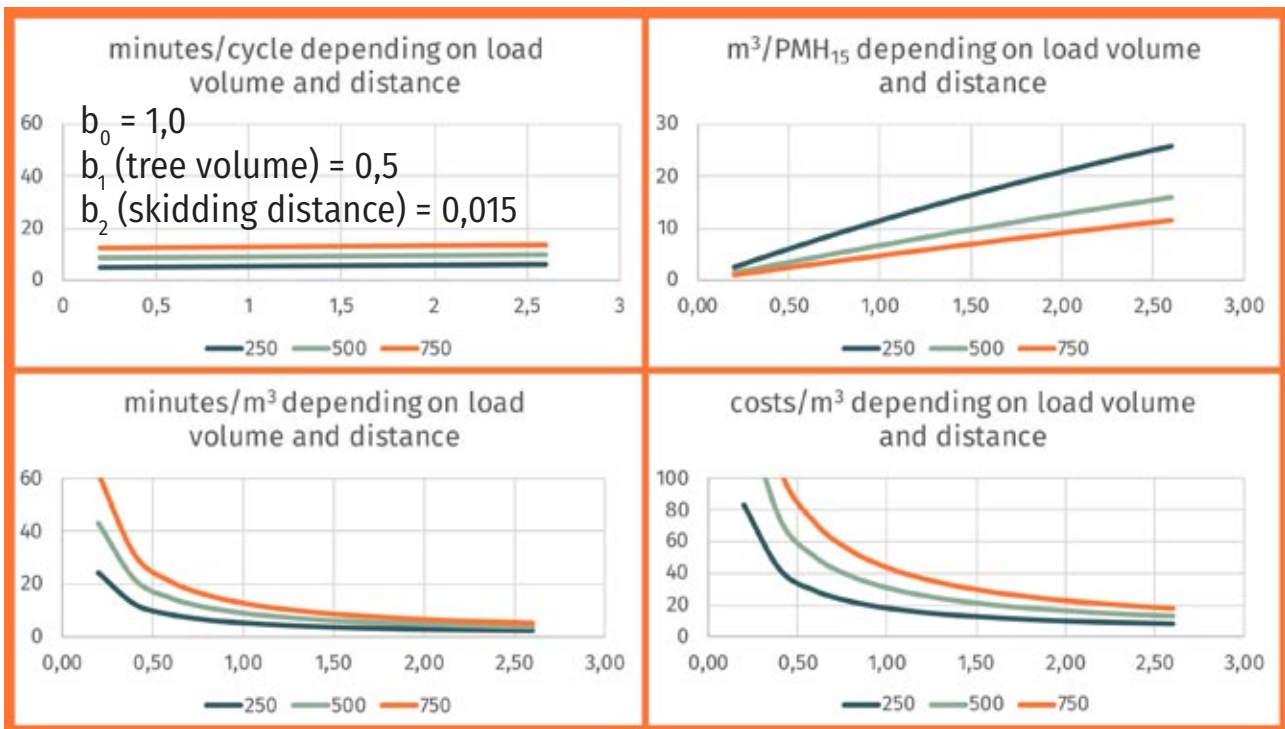

System costs (example)

- machine costs without personal costs: 100,00 Euro/h
- personal costs per person: 35,00 Euro/h
- number of persons: 3
- in total: 205,00 Euro/h
- plus costs for installation and dismantle of the cable system

Ecological suitability

- Ecogram

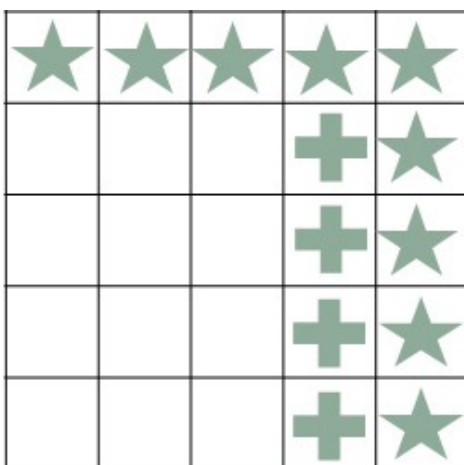

Social suitability:

- S-class: unloading full trees on forest road > S3
- E-class: simple machine work, heavy and dangerous > E3

SP-x2-x3 motor-manual cross-cutting

After measuring and decision where the optimal cuts have to be set, the trunk is cut into two or more pieces, (nearly) each of them marketable assortment.

Funciogram

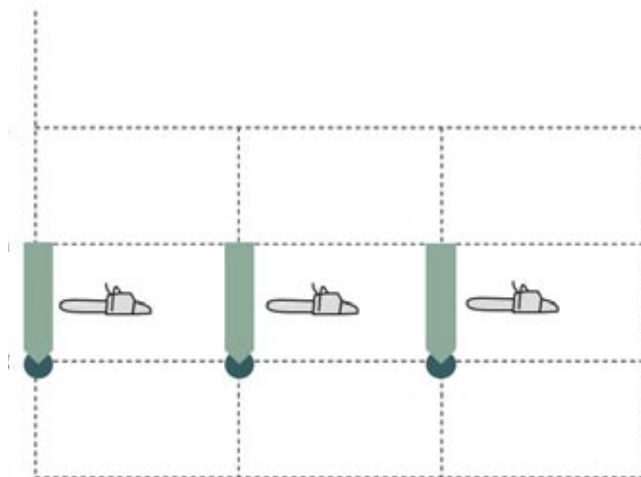

Advantages

- to separate assortments, due to the requirements of different customers
- enable collecting machines (like forwarder) to collect, lower damage in stand and on soil

Limitations, thresholds

- costs
- dangerous work on steep terrain

Main use

- separating logs to different assortments
- on skid road = separate forwarding
- poplar plantations in Italy (buyer-marked)
- high-value assortment production, customer-driven grading (veneer)

Economic suitability

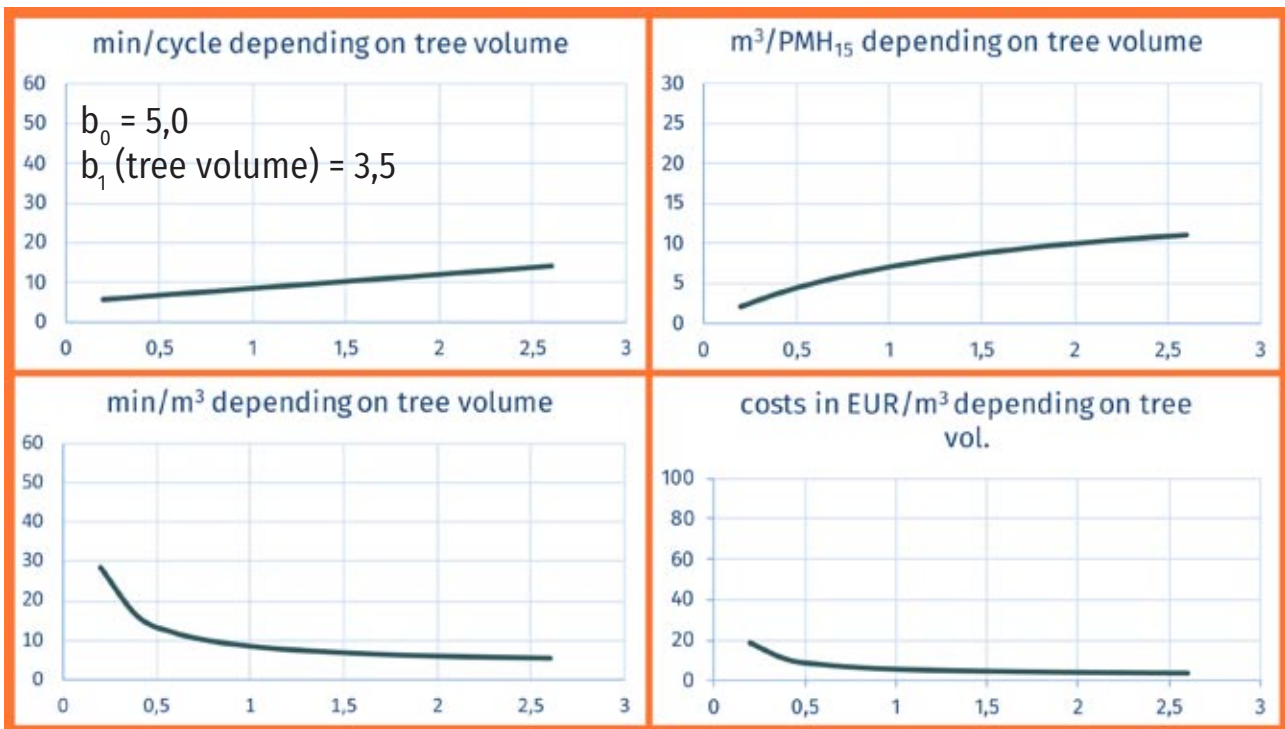

System costs (example)

- machine costs without personal costs: 4,00 Euro/h
- personal costs per person: 35,00 Euro/h
- number of persons: 1
- in total: 39,00 Euro/h

Ecological suitability

- Ecogram

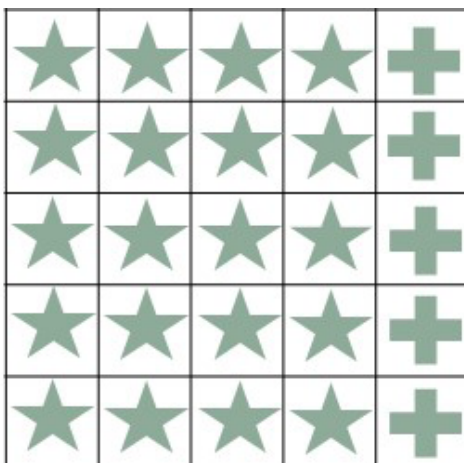

Social suitability:

- S-class: in the stand or on the trail no contact with the forest road > S5
- S-class: processing on the forest road > S2
- E-class: motor-manual work, very heavy and dangerous > E2

SP-12-22 pre-skidding of tree lengths with a horse

After felling, delimiting, and topping, tree lengths are pre-skidded to a strip road using animals, and most commonly draught horses. Different breeds are available in different regions, but the most popular are heavy breeds like French Percherons, Belgian Ardennes, or Italian TPR.

Funciogram

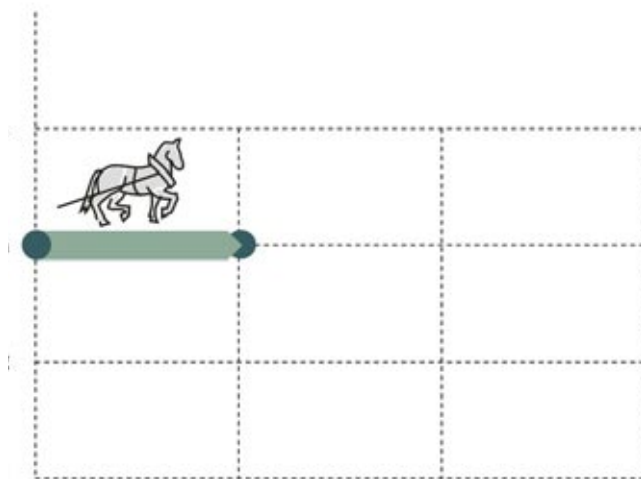

Advantages

- able to work in dense stands that are too narrow for machines
- some species are capable to work on steep terrain
- very low soil and stand impacts
- comfort for the operator due to low stress from the work itself

Limitations, thresholds

- the system is suitable for young trees only, as obtained from first and second thinnings, or to coppice harvesting operations.
- distance must not exceed 200 m. Best results are obtained on shorter distances, between 25 and 100 m.
- extraction must proceed on flat terrain or downhill slopes, with a maximum gradient of 50%
- draught animals can only work 5 to 6 hours a day.

Main use

- Animal pre-skidding is rarely used in industrialized countries, where it remains a specialist niche. The reason is in the small numbers of horse loggers, ready to accept the constant commitment imposed by animal care.

Economic suitability

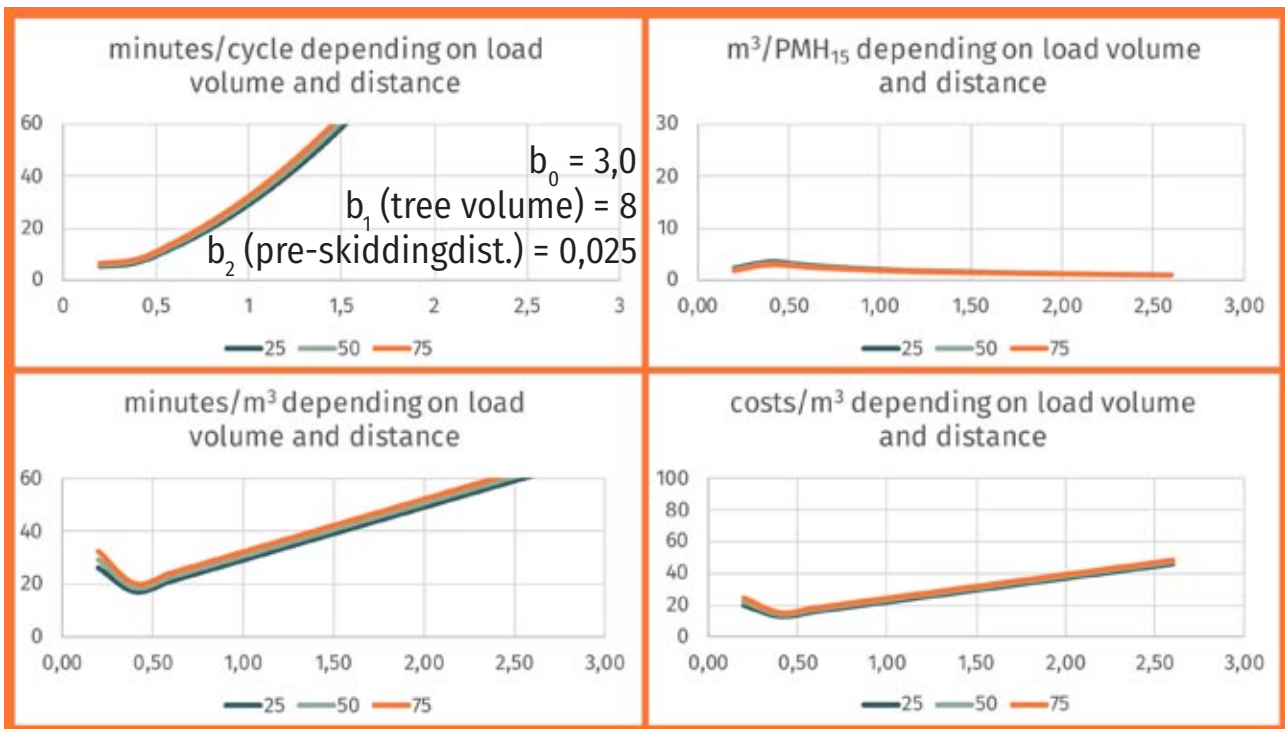

System costs (example)

- machine costs without personal costs: 10,00 Euro/h
- personal costs per person: 35,00 Euro/h
- number of persons: 1
- in total: 45,00 Euro/h

Ecological suitability

- Ecogram

★	★	+	-	
★	★	+	-	

Social suitability:

- S-class: no contact with forest road > S5
- E-class: manual work, very heavy and dangerous > E1

SP-11-22 pre-skidding of tree lengths with tractor winch

Tree lengths that are felled and delimbed are pulled to the trail with a winch that is mounted or attached to a tractor.

Funciogram

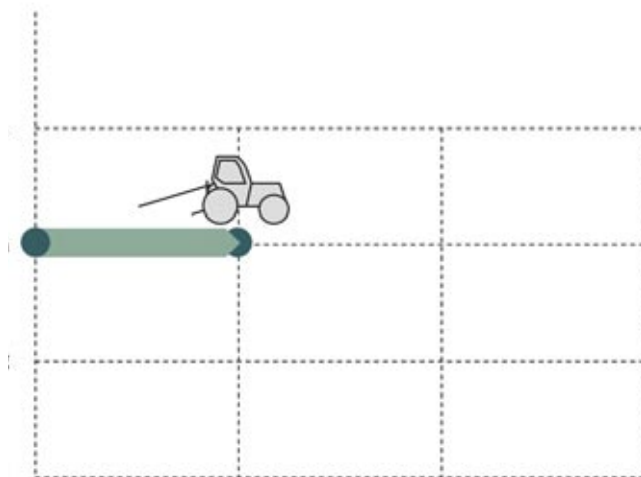

Advantages

- extraction over long distance without driving on the ground
- extracting in steep terrain (uphill)
- bringing trees to a site where machines for delimiting and cross-cutting can operate
- compared with full trees, tree-lengths offer less resistance to drag and are easier to move within the stand
- compared with full trees, no nutrient removal

Limitations, thresholds

- distance limited by the length of the cable, often up to 100 m
- distance limited by the weight of the cable that must be pulled by the worker, so on flat terrain not more than 50 m, downhill wider distances are possible
- cable cannot be pulled uphill, therefore no downhill extraction over longer distance

Main use

- in stands where fully mechanized methods are not applicable due to ground conditions, tree species (large broadleaved trees, e.g.)
- with wider distance between trails, where trees must be pulled into the reach of the crane of a machine
- in combination with extraction by means of a tractor



Economic suitability

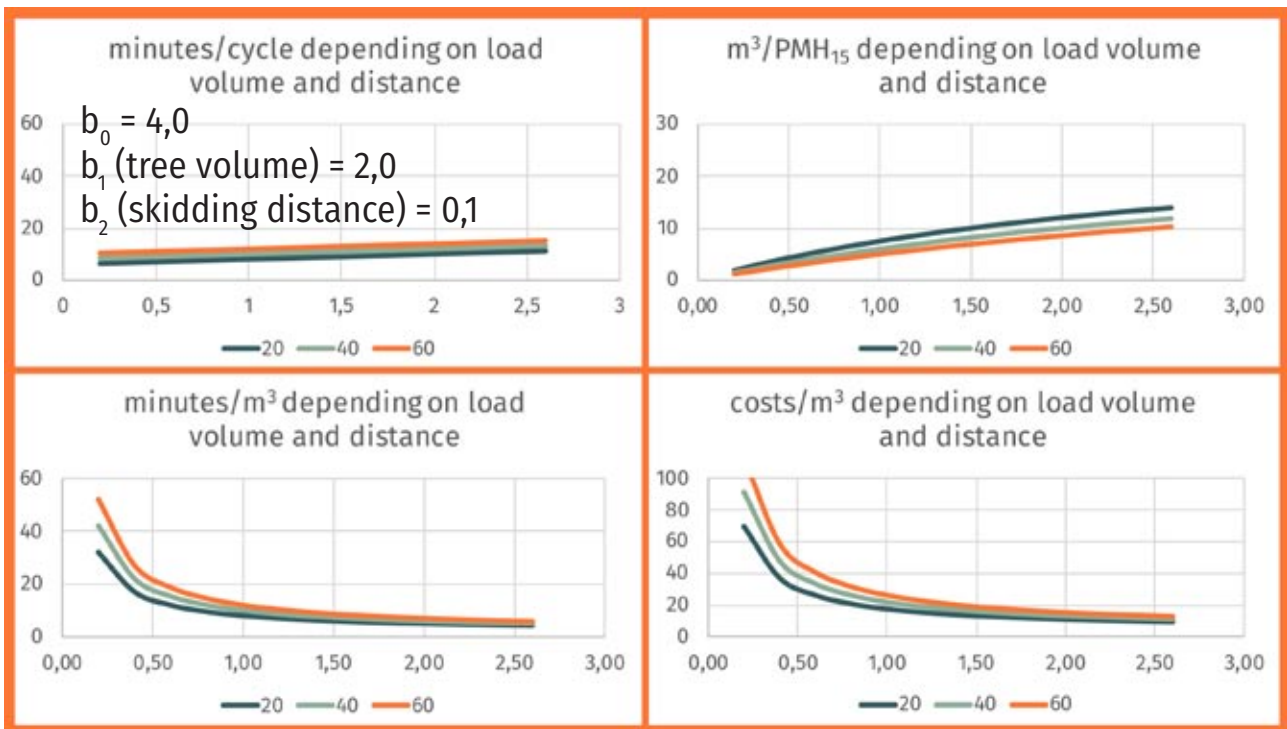

System costs (example)

- machine costs without personal costs: 60,00 Euro/h
- personal costs per person: 35,00 Euro/h
- number of persons: 2
- in total: 130,00 Euro/h

Ecological suitability

- Ecograms: wheels left without traction chains, right with traction chains

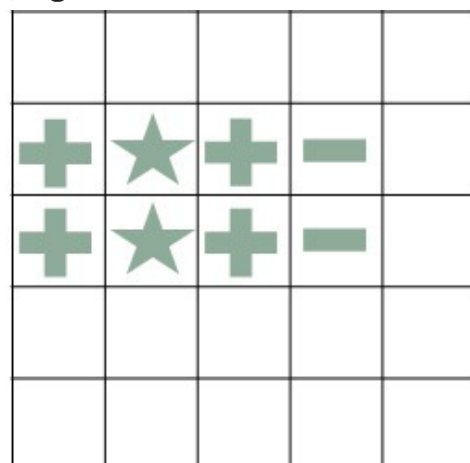
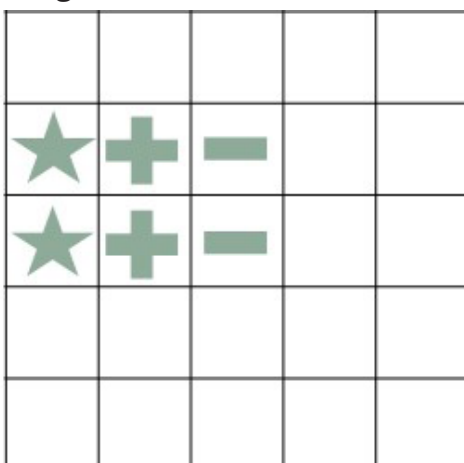

Social suitability:

- S-class: no contact with forest road > S5
- E-class: simple machine work, heavy and dangerous > E3

SP-11-32 mechanized pre-skidding and skidding of tree lengths with skidder

Tree-lengths are dragged to the landing by a tractor equipped with a single or double-drum winch. The winch is used for assembling the load and for pre-skidding the tree-lengths to the skid trail if necessary.

Funciogram

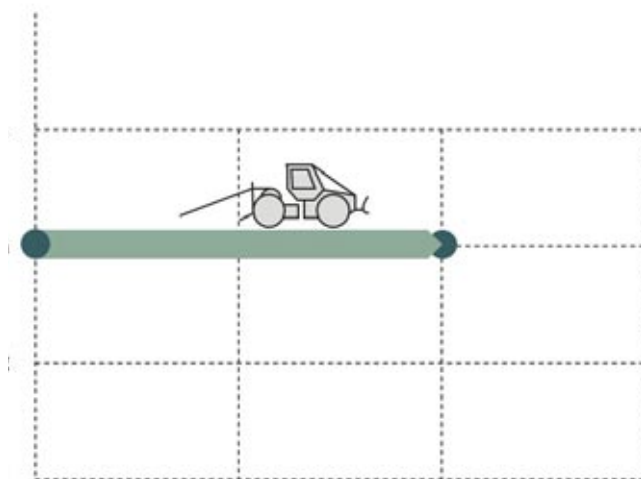

Advantages

- independent pre-skidding and extraction capacity in one unit
- can operate on steep terrain, if skid trails are available at a suitable spacing

Limitations, thresholds

- slow (pre-skidding)
- need an assistant (chokerman) and/or the driver needs to leave the cab (uncomfortable)
- limited load capacity

Main use

- mountain operations
- small-scale forestry
- traditional extraction method when crosscutting should not be done before reaching the forest road (or the customer)



Economic suitability

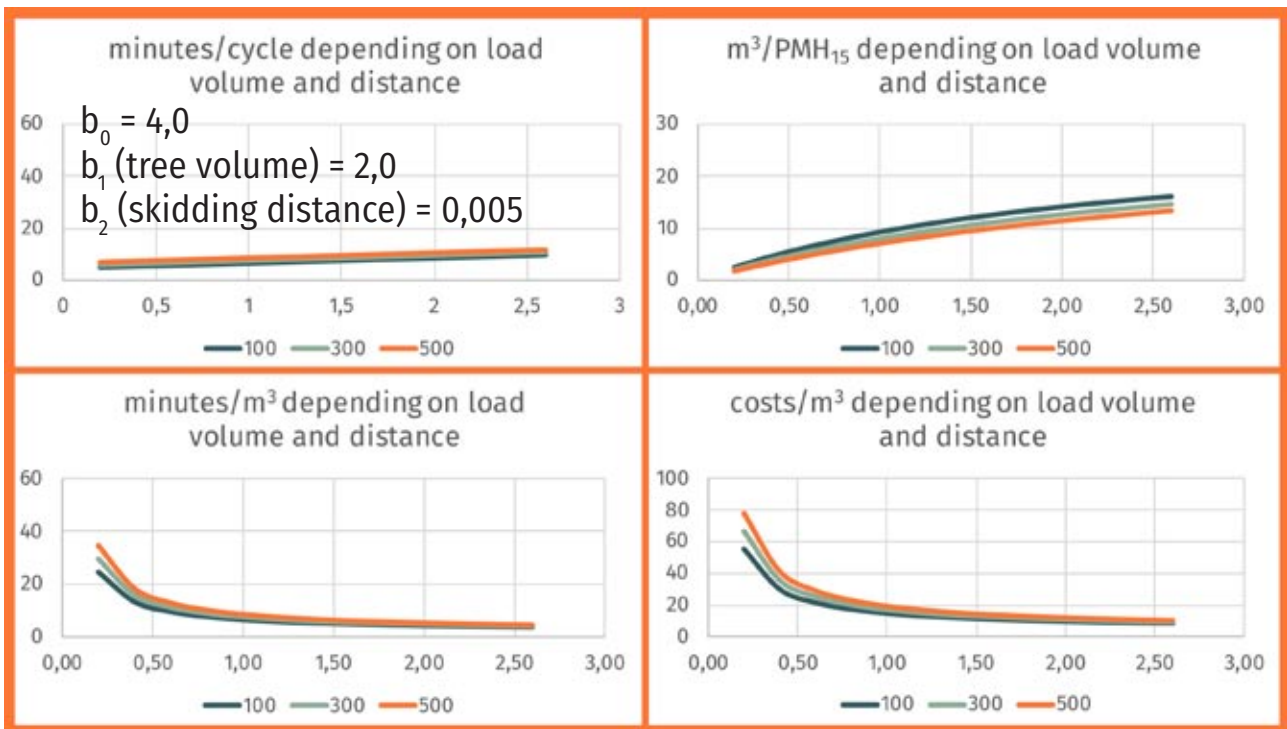

System costs (example)

- machine costs without personal costs: 65,00 Euro/h
- personal costs per person: 35,00 Euro/h
- number of persons: 2
- in total: 135,00 Euro/h

Ecological suitability

- Ecograms: wheels left without traction chains, right with traction chains

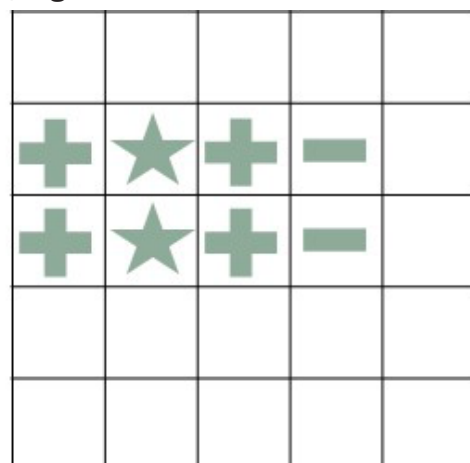
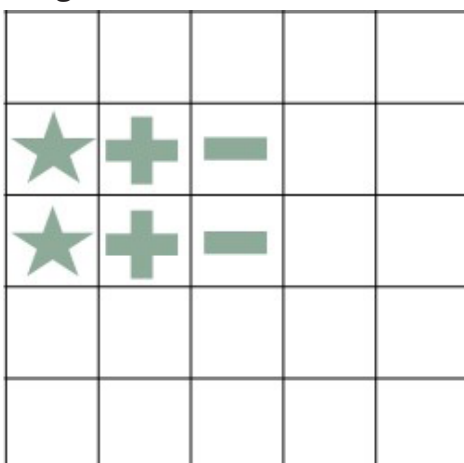

Social suitability:

- S-class: unloading tree length on the road > S3
- E-class: simple machine work, heavy and dangerous > E3

SP-12-32 mechanized pre-skidding and skidding of tree lengths with yarder

Tree lengths are moved to a landing (roadside landing, landing pad etc.) suspended under a carriage that runs on a cable (skyline). Different types and configurations are available (live, standing, running skyline, self-propelled carriage, swing yarders – carriages with cable or grapple)

Funcdiagram

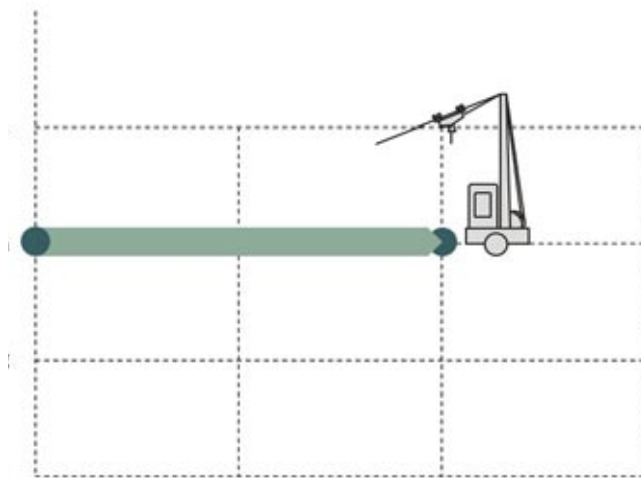

Advantages

- capable of working in steep terrain
- less soil disturbance than for ground-based
- capable of pre-skidding loads (drop line)
- can work with limited road network

Limitations, thresholds

- relatively long set-up and dismantle time
- Fixed set-up and dismantle time require relative intensive removal (ca. 0.5-1 m³/ m line)
- high planning effort
- requires high operator skill

Main use

- mountain operations
- alpine forestry

Economic suitability

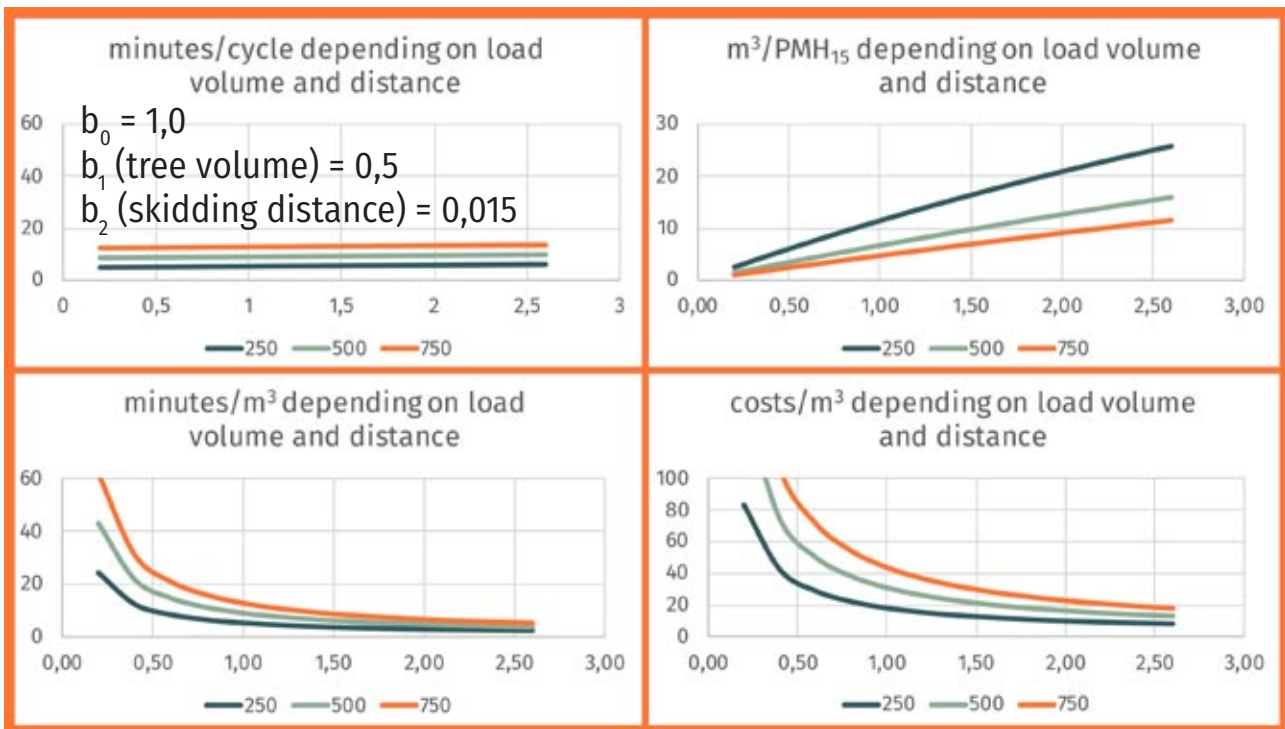

System costs (example)

- machine costs without personal costs: 100,00 Euro/h
- personal costs per person: 35,00 Euro/h
- number of persons: 3
- in total: 205,00 Euro/h

Ecological suitability

- Ecogram

★	★	★	★	★
			+	★
			+	★
			+	★
			+	★

Social suitability:

- S-class: unloading tree length on the road > S3
- E-class: simple machine work, heavy and dangerous > E3

SP-13-32 manual pre-skidding of short logs

Short logs can be moved manually by workers by throwing them downhill, or sliding them with the use of sappies or chutes.

Funciogram

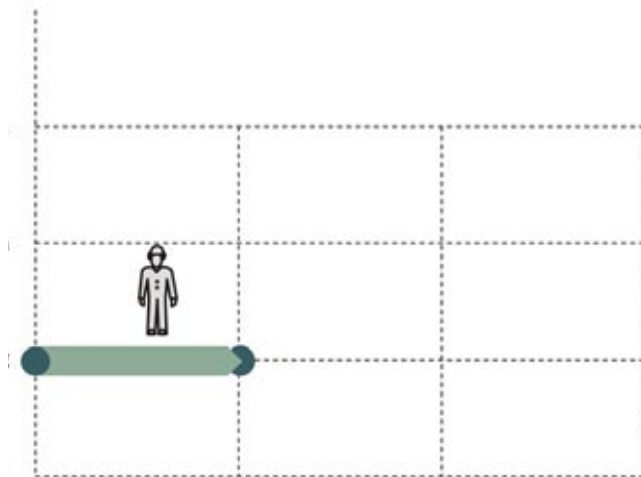

Advantages

- limited (or no) investment for manual sliding
- capacity to deal with almost any terrain conditions
- limited impact

Limitations, thresholds

- short distance only
- downhill if sliding or throwing
- very low productivity
- only works with relatively small and short logs that are within the weight capacity of human power

Main use

- small scale forestry

Economic suitability

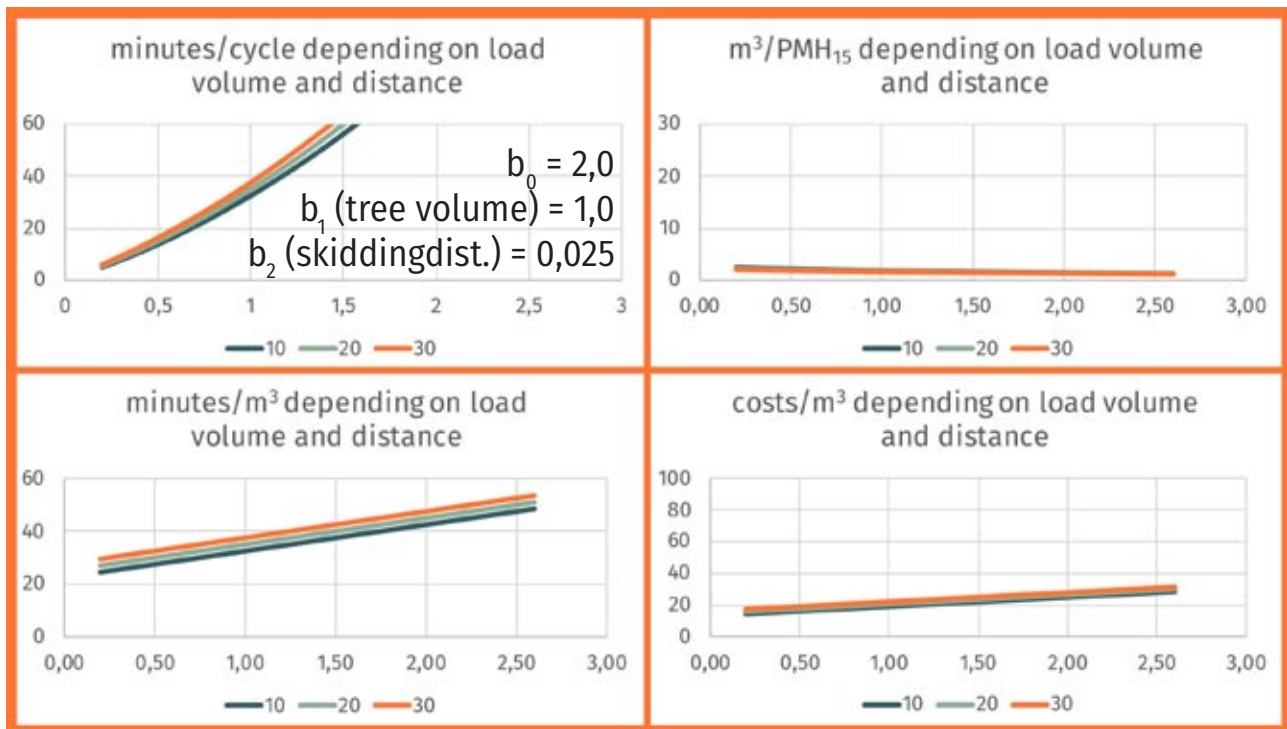

System costs (example)

- without special equipment no machine costs
- personal costs per person: 35,00 Euro/h
- number of persons: 1
- in total: 35,00 Euro/h
- maximal load per cycle 0,1 m^3 t

Ecological suitability

- Ecogram

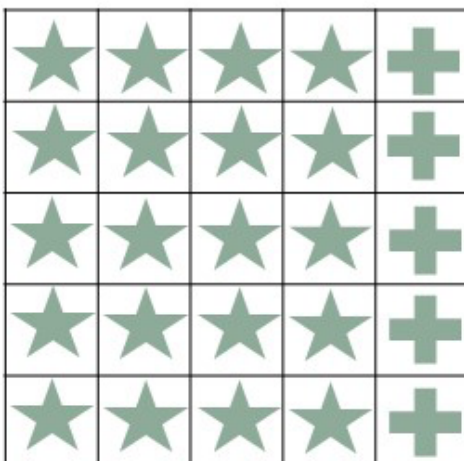

Social suitability:

- S-class: no contact with forest road > S5
- E-class: manual work, very heavy and dangerous > E1

SP-13-23 pre-skidding of logs with animal

Short logs can be pre-skidded (dragged or carried) by draught horses or mules

Funcdiagram

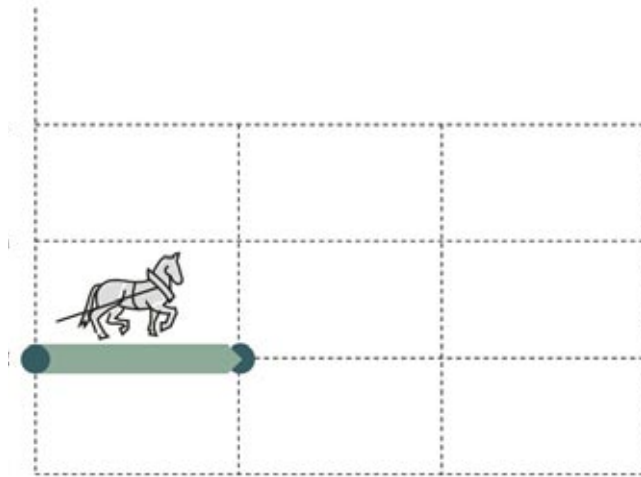

Advantages

- capacity to deal with almost any terrain conditions
- limited impact

Limitations, thresholds

- short distance only
- animals need training and constant care
- low productivity
- only works with relatively small and short logs that are within the weight capacity of animal power

Main use

- small scale forestry

Economic suitability

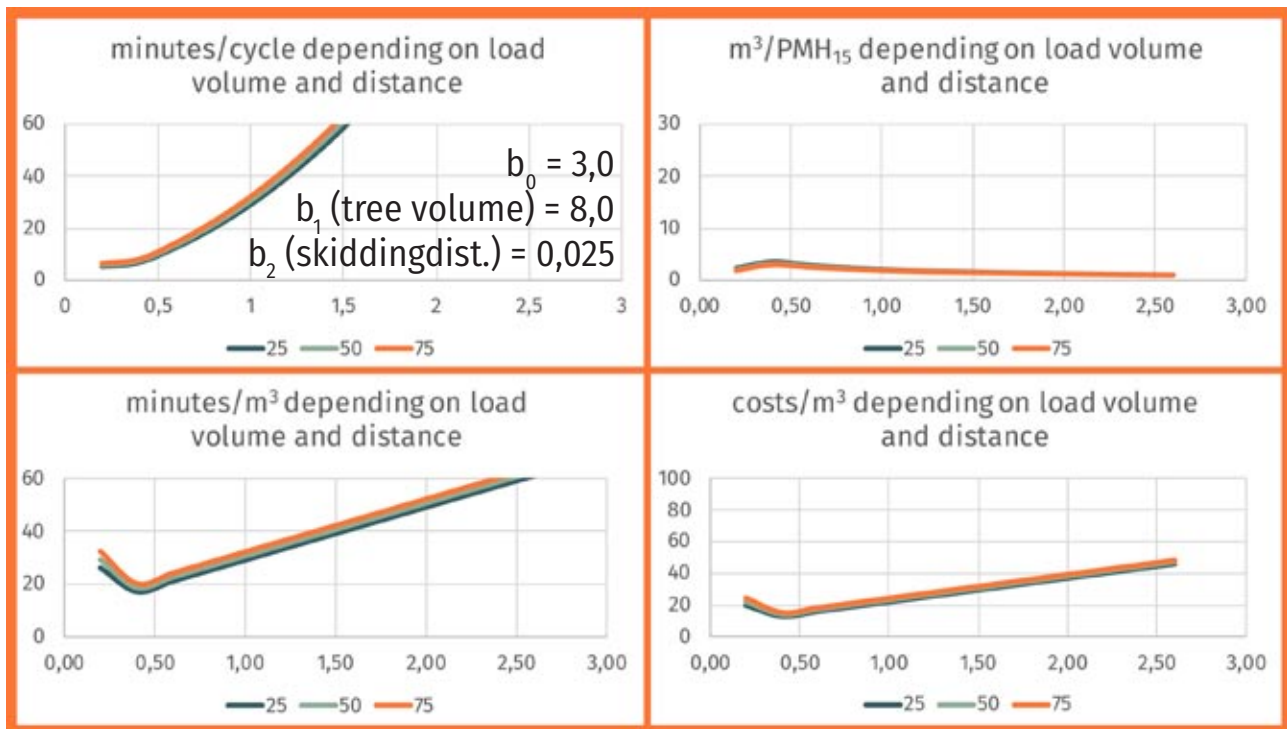

System costs (example)

- costs without personal costs: 10,00 Euro/h
- personal costs per person: 35,00 Euro/h
- number of persons: 1
- in total: 45,00 Euro/h

Ecological suitability

- Ecogram

★	★	+	-	
★	★	+	-	

Social suitability:

- S-class: no contact with forest road > S5
- E-class: manual work, very heavy and dangerous > E1

SP-13-23 mechanized pre-skidding of logs

When trees are delimited and cross-cut at the felling site, the logs must be pre-skidded to the trail separately. This is only rational when the weight of the tree length is too high. For example, the bottom log can be separated from the rest of the stem before pre-skidding.

Funciogram

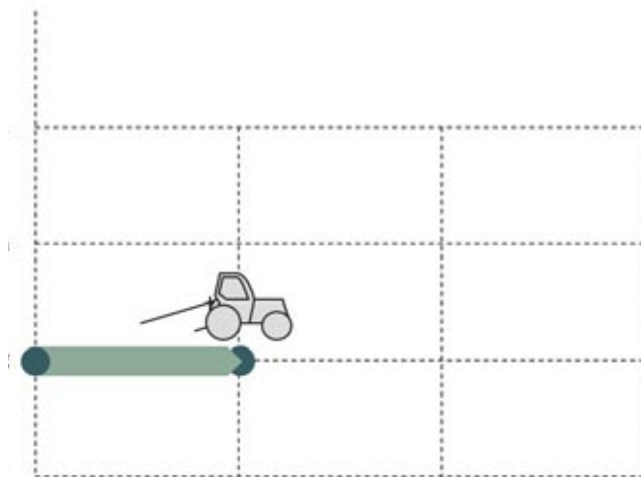

Advantages

- low weights, lower damage in the stand

Limitations, thresholds

- low productivity

Main use

- small scale forestry
- simple, light machines with a single drum winch



Economic suitability

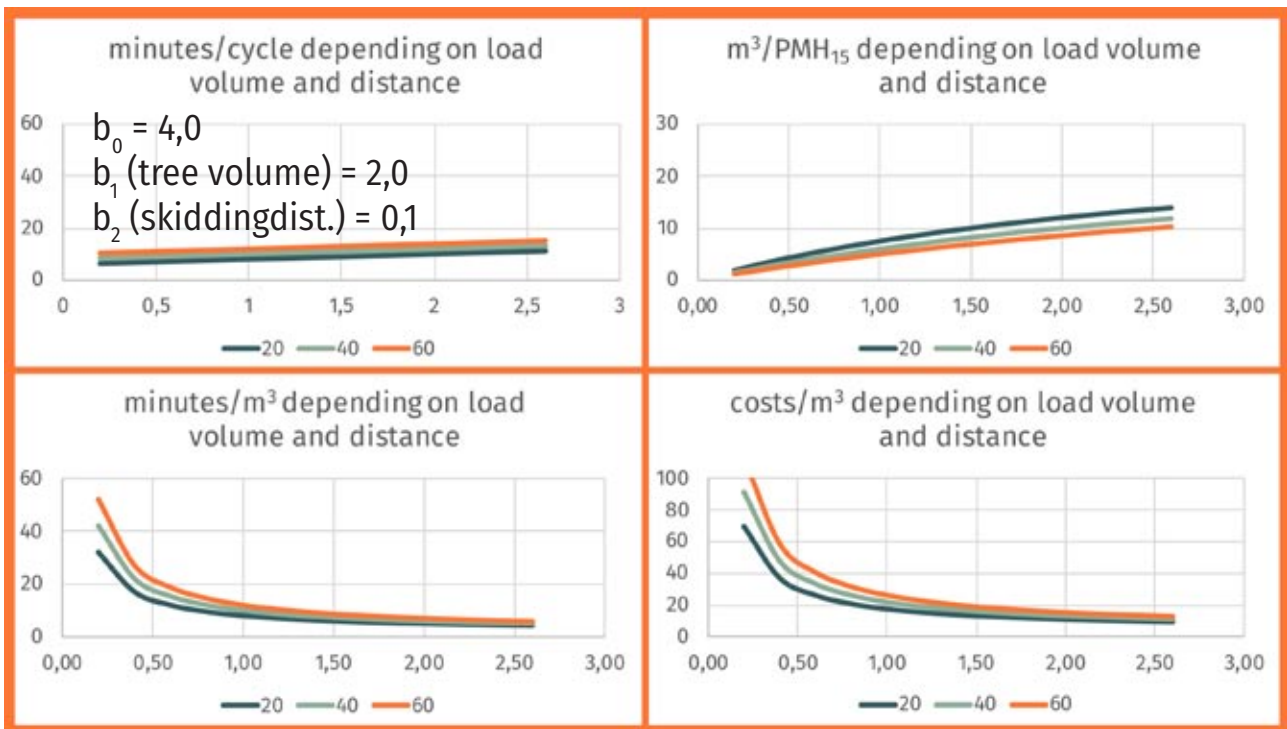

System costs (example)

- machine costs without personal costs: 60,00 Euro/h
- personal costs per person: 35,00 Euro/h
- number of persons: 2
- in total: 130,00 Euro/h

Ecological suitability

- Ecograms: wheels left without traction chains, right with traction chains

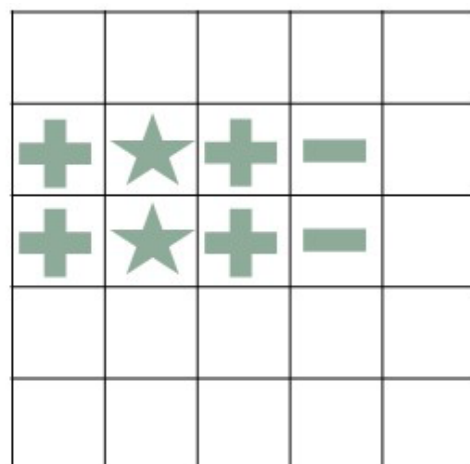
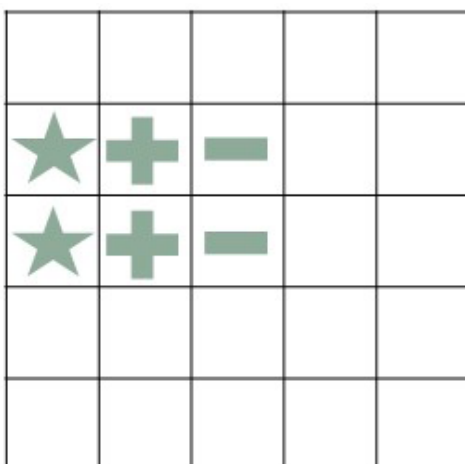

Social suitability:

- S-class: no contact with forest road > S5
- E-class: simple machine work, heavy and dangerous > E3

SP-21-23 mechanized processing on the trail

Processor (or harvester) standing on skid road processing the full tree that is laying down in reach of a crane. The processing includes measuring, forecasting dimension, suggesting assortments, delimiting and cross-cutting.

Funciogram

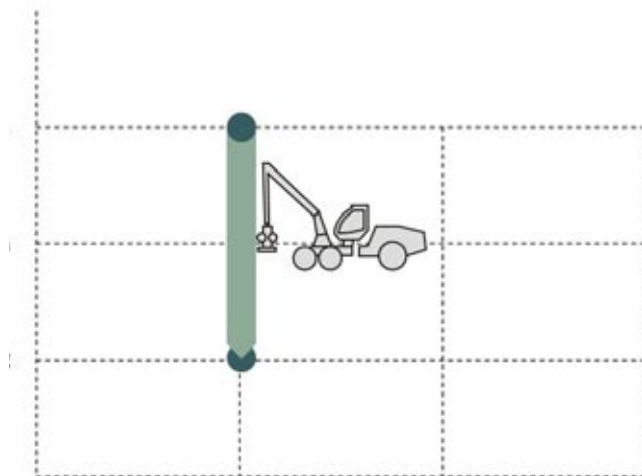

Advantages

- high productivity, low price (if fully utilized)
- low danger, low ergonomic injuries

Limitations, thresholds

- good for coniferous trees with straight stems
- limited with bigger, crooked or broadleaves trees

Main use

- on accessible skid roads
- coniferous trees, younger broadleaves trees
- distance of skid roads > 2x reach of crane



Economic suitability

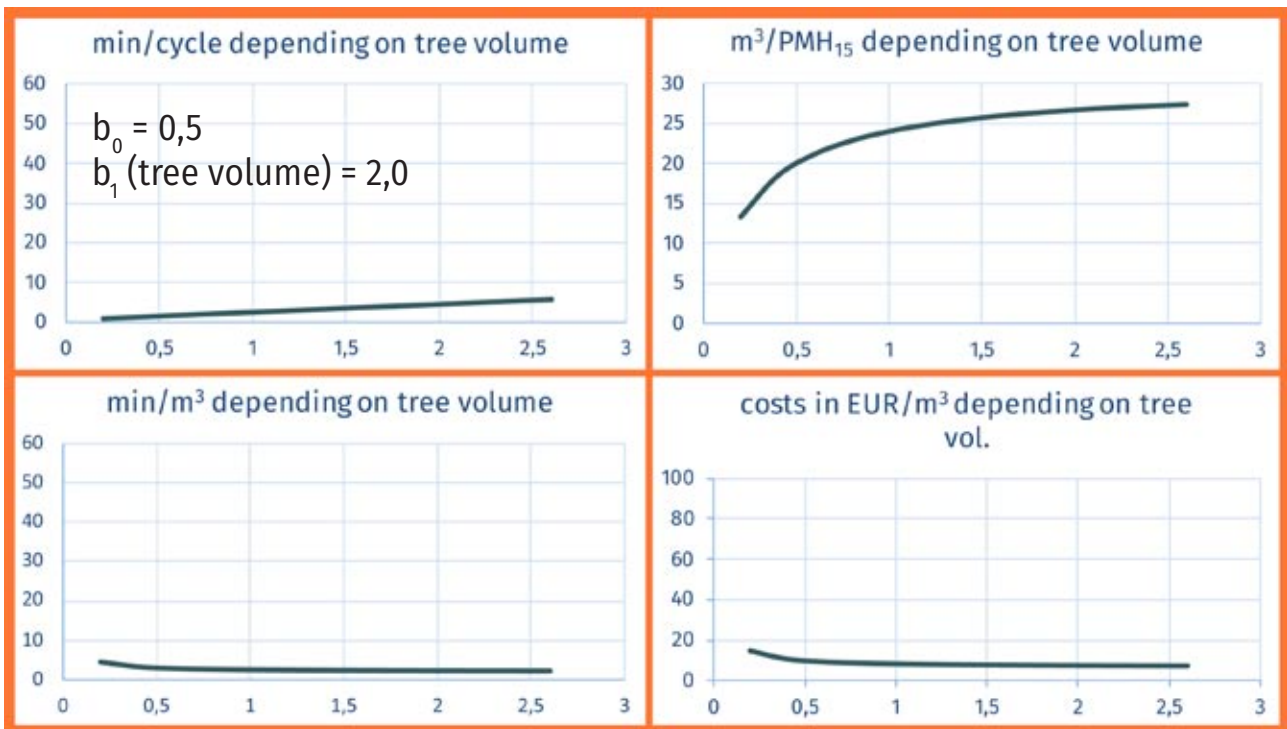

System costs (example)

- machine costs without personal costs: 160,00 Euro/h
- personal costs per person: 35,00 Euro/h
- number of persons: 1
- in total: 195,00 Euro/h

Ecological suitability

- Ecograms: bogies left without bends, right with bends

★	+	—		
★	+	—		
★	+	—		
★	+	—		

+	★	+	—	
+	★	+	—	
+	★	+	—	
+	★	+	—	

Social suitability:

- S-class: no contact with forest road > S5
- E-class: automatic machine work, moderate > E5

SP-21-31 skidding of full trees with clam-bunk skidder

Full trees are skidded with their butts resting on the rear axle of the skidder, while tree tops dragged on the ground. The butts are retained on top of the rear axle by an inverted grapple (clambunk) and placed on that grapple using a hydraulic loader.

Funciogram

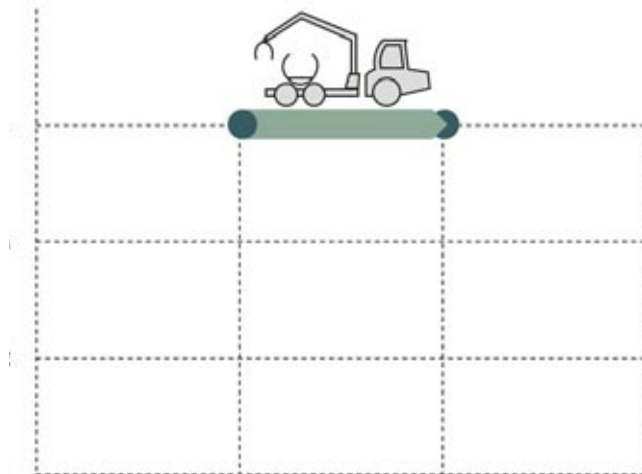

Advantages

- much reduced friction, soil disturbance and contamination
- larger loads can be assembled, than it would be possible with a cable or grapple skidder

Limitations, thresholds

- large machine, very heavy and expensive
- limited maneuverability, clumsy

Main use

- plantation forestry
- boreal forests on solid ground
- whenever long assortments need to be produced, and logs cannot be cut short (conversion kits for forwarders and skidders available)
- costs per m³ depending on tree volume



Economic suitability

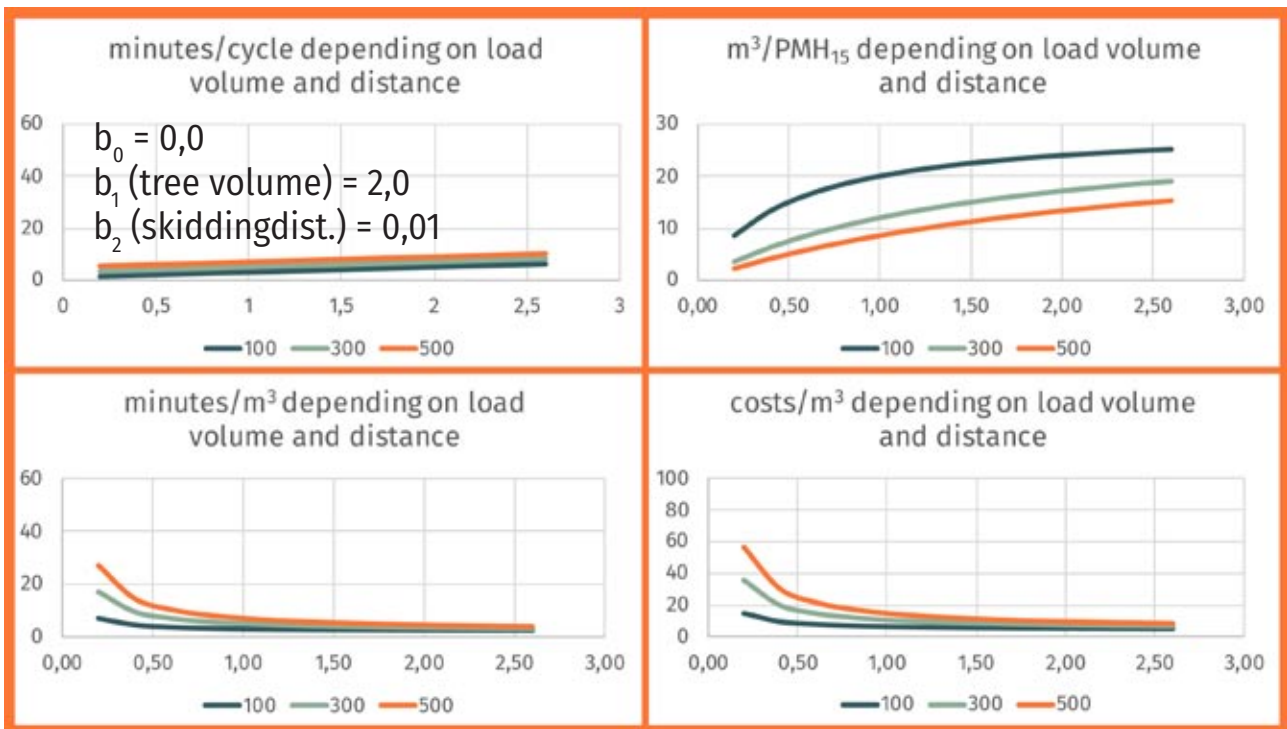

System costs (example)

- machine costs without personal costs: 90,00 Euro/h
- personal costs per person: 35,00 Euro/h
- number of persons: 1
- in total: 125,00 Euro/h

Ecological suitability

- Ecograms: wheels left without traction chains, right with traction chains

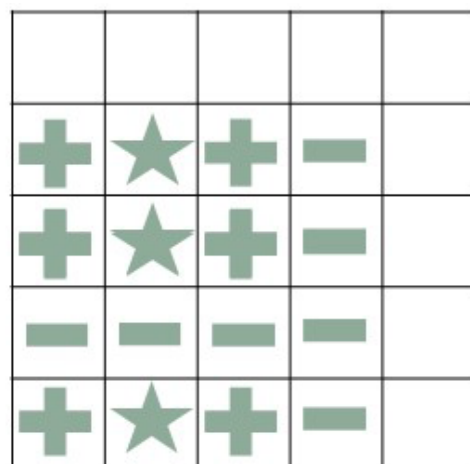
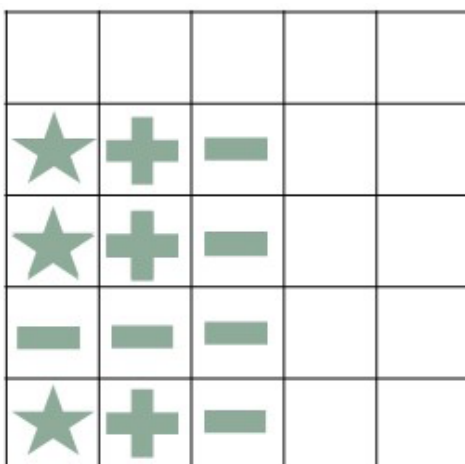

Social suitability:

- S-class: unloading full trees on the road > S3
- E-class: advanced machine work, moderate > E4

SP-21-31 mechanized skidding of full tree with grapple skidder

Full trees are dragged to the roadside landing by a machine that uses a grapple to grab and hold the trees.

Funciogram

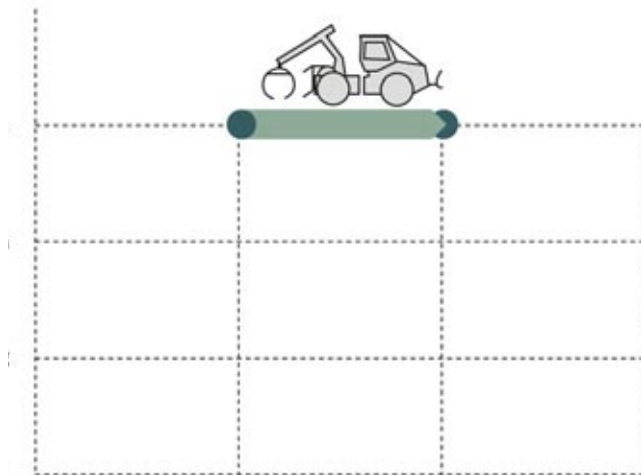

Advantages

- very fast loading and unloading
- no need to have an assistant to hook the loads
- no need for the operator to leave the cab
- by chains also possible on softer soils

Limitations, thresholds

- trees need to be pre-bunched for the system to be efficient
- smaller payload than for a clambunk or a forwarder
- high speed and many repetitive cycles are heavy on the operator

Main use

- plantation forestry (grapple-skidders on pre-bunched trees)



Economic suitability

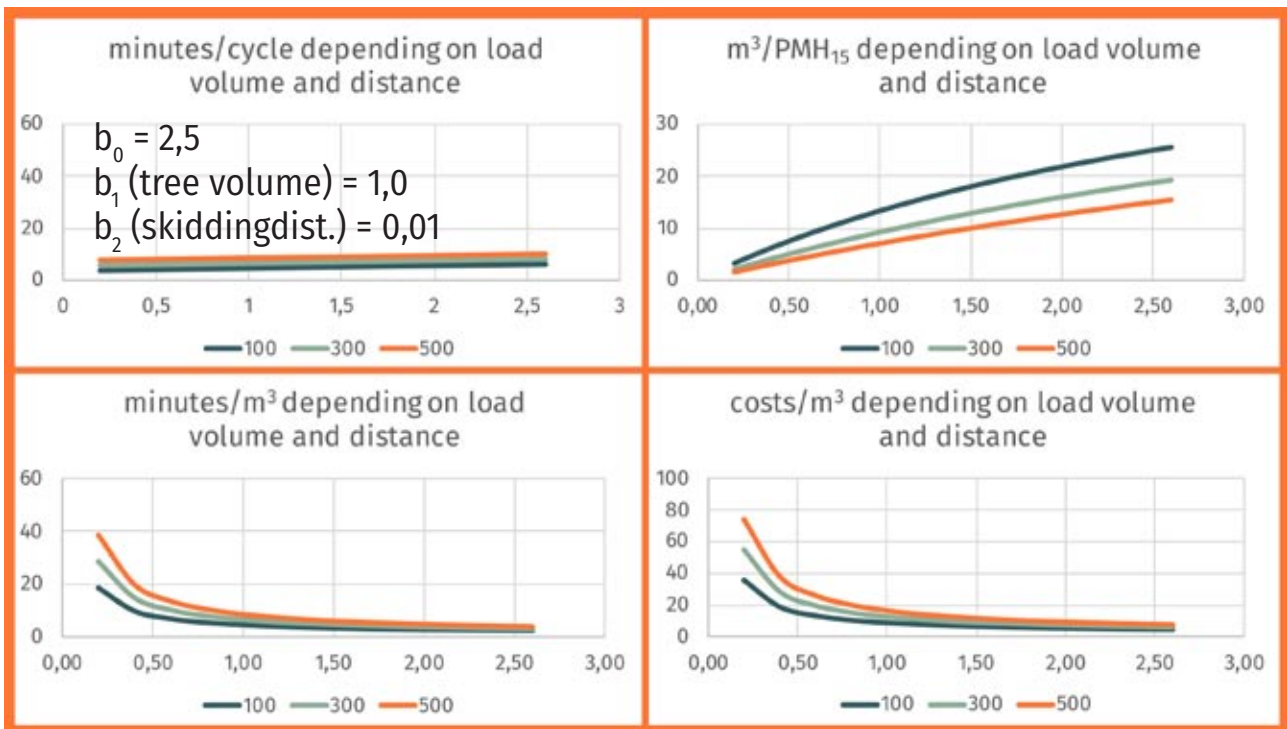

System costs (example)

- machine costs without personal costs: 80,00 Euro/h
- personal costs per person: 35,00 Euro/h
- number of persons: 1
- in total: 115,00 Euro/h

Ecological suitability

- Ecograms: wheels left without traction chains, right with traction chains

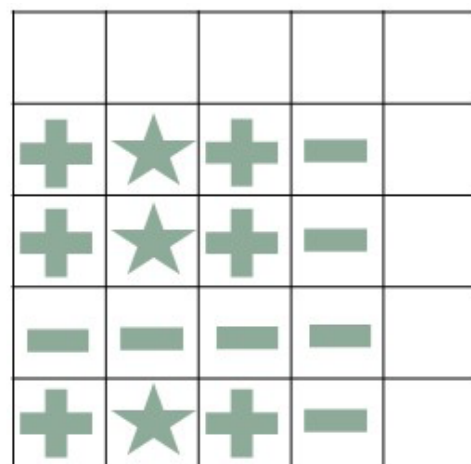
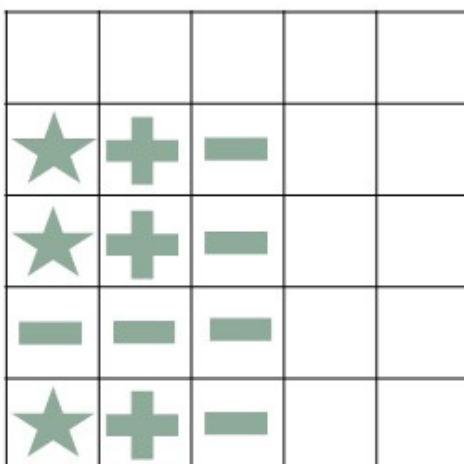

Social suitability:

- S-class: unloading full trees on the road > S3
- E-class: advanced machine work, moderate > E4

SP-21-31 mechanized skidding of full trees with skidder

Full trees are dragged to the roadside landing by a tractor (dedicated skidder, crawler, forestry fitted farm tractor) using chains or cable.

Funciogram

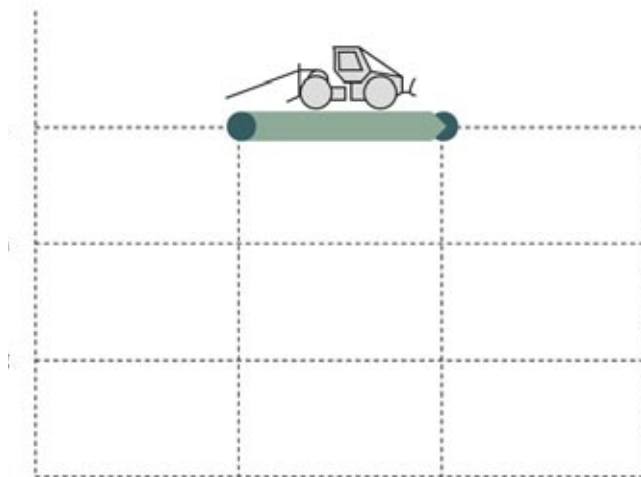

Advantages

- it does not require to process the trees in the forest
- simple machine and procedure
- it can drag long loads
- high speed

Limitations, thresholds

- it requires large landings or a separate loader
- needs skid trail in dense stands and or on steep terrain
- relatively small payload
- high speed and many repetitive cycles are heavy on the operator
- aggressive on the soil (esp. crawlers in steep terrain)
- operator needs to leave the cab and re-enter the cab twice per cycle, unless an assistant is available to do so (uncomfortable)

Main use

- mountain operations
- when we are not able to run a harvester-forwarder system and want to mechanize at roadside by processor (or chipper)



Economic suitability

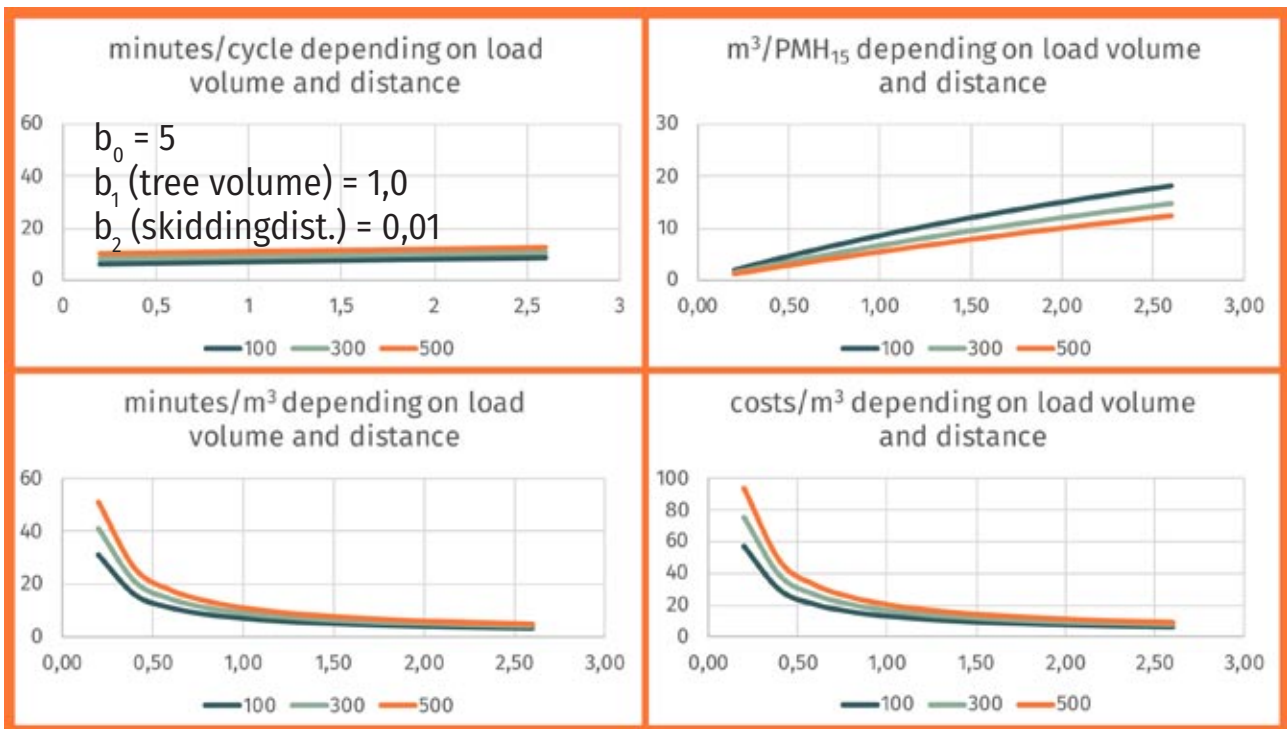

System costs (example)

- machine costs without personal costs: 40,00 Euro/h
- personal costs per person: 35,00 Euro/h
- number of persons: 2
- in total: 110,00 Euro/h

Ecological suitability

- Ecograms: wheels left without traction chains, right with traction chains

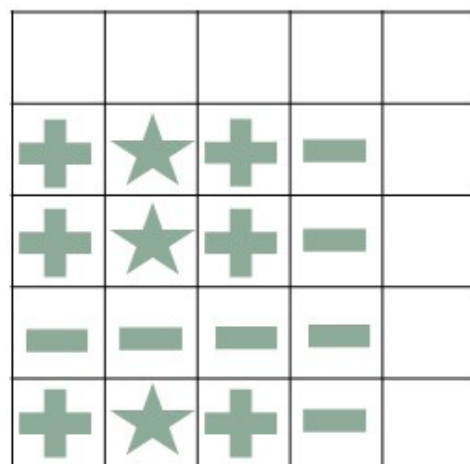
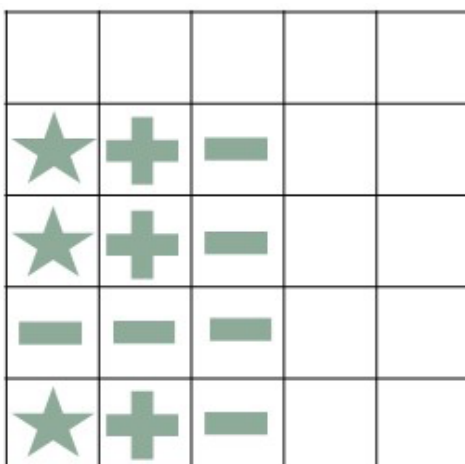

Social suitability:

- S-class: unloading full trees on the road > S3
- E-class: simple machine work, heavy and dangerous > E3

SP-21-34 mechanized chipping of full trees on the trail

Full trees that are laid down alongside the trail are chipped by a self-propelled chipper or a tractor powered chipper with off-road capability. Chips are blown into an integrated bin and then transferred to a chip shuttle (forwarder-based) or into a bin trailer, towed by the same tractor or by an accompanying tractor.

Funciogram

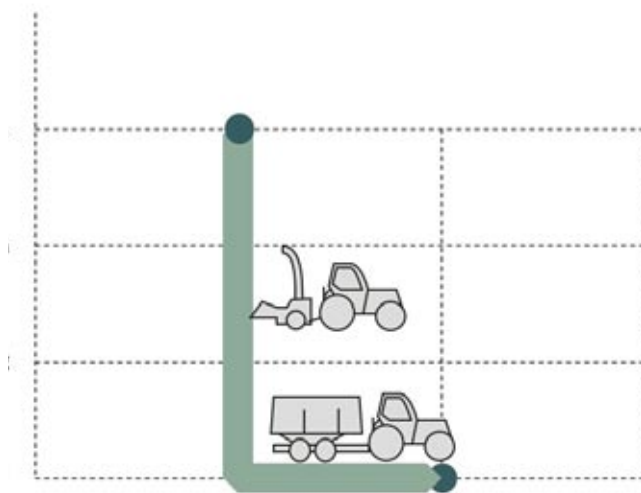

Advantages

- trees are converted into chips as early as possible to accrue all advantages of bulk density reduction and “fluidization“
- minimum tree handling
- minimum contamination

Limitations, thresholds

- needs suitable terrain conditions
- expensive machinery
- potential for interaction delays in the chipper-shuttle interface
- temptation to use the integral bin as a chip-forwarder (only on a very short distances)

Main use

- Danish forestry – thinning there is very effective



Economic suitability

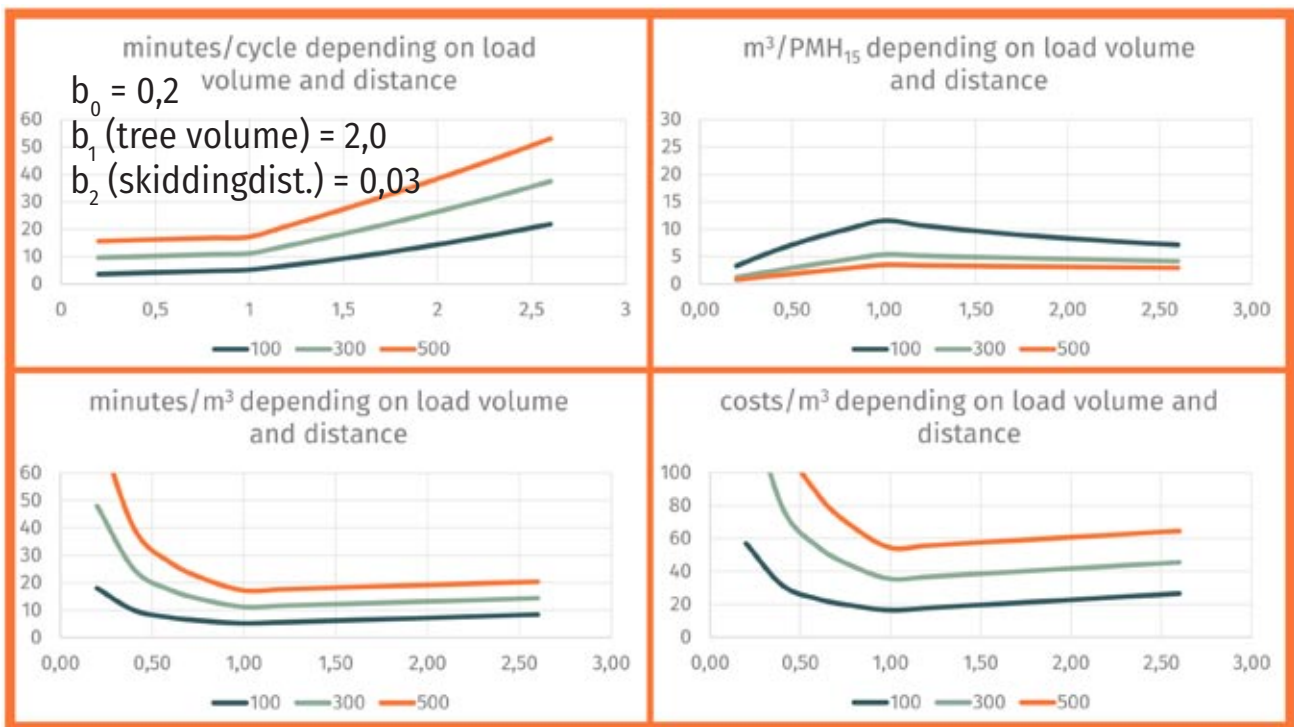

System costs (example)

- machine costs without personal costs: 120,00 Euro/h
- personal costs per person: 35,00 Euro/h
- number of persons: 2
- in total: 190,00 Euro/h

Ecological suitability

- Ecograms: wheels left without traction chains, right with traction chains

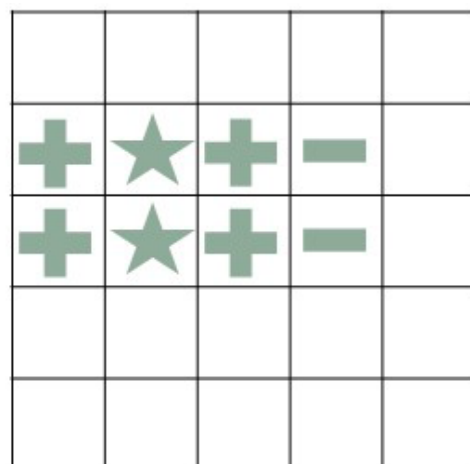
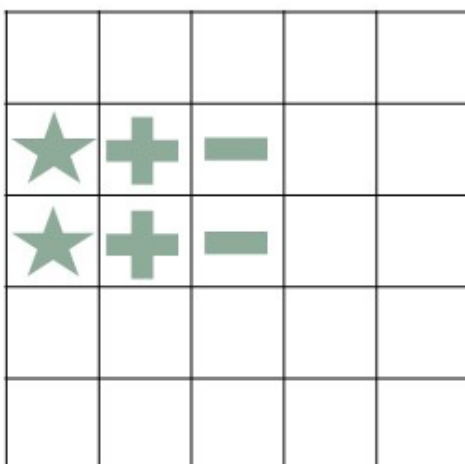

Social suitability:

- S-class: no contact with forest road > S5
- E-class: advanced machine work, moderate > E4

SP-22-32 mechanized skidding of tree lengths with clam-bunk skidder

Tree lengths that are pre-skidded to the trail are skidded to the forest road using a clam-bunk skidder. This includes: loading the trees with the crane into the clam-bunk, skidding them to forest road, storing them alongside road or a landing.

Funciogram

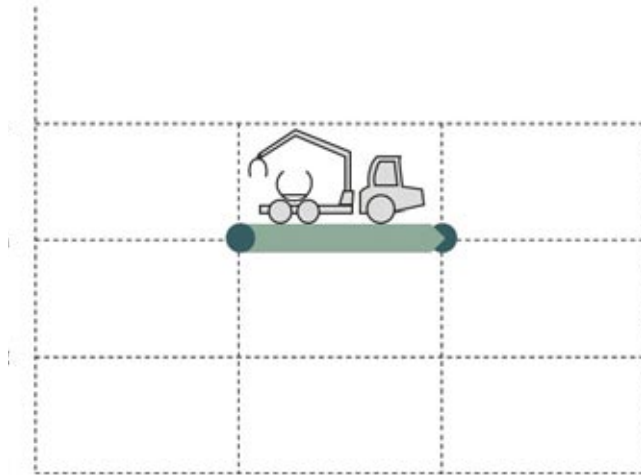

Advantages

- compared with full trees one can build bigger loads (about 30 %)
- compared with skidder, the driver can remain in the cabin
- high productivity

Limitations, thresholds

- large machine, very heavy and expensive
- limited maneuverability, clumsy

Main use

- traditional extraction method when crosscutting should not be done before reaching the forest road (or the customer)
- high extraction volume like clear-cuts or wind-throws

Economic suitability

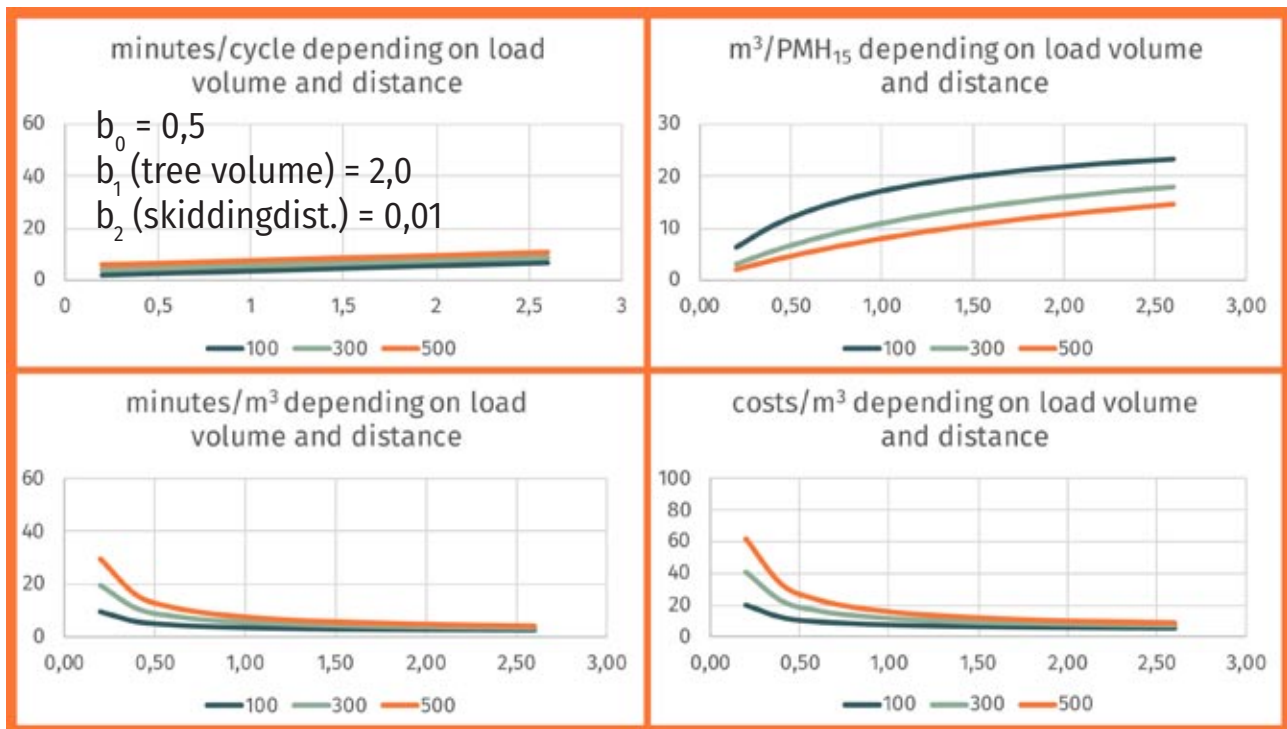

System costs (example)

- machine costs without personal costs: 90,00 Euro/h
- personal costs per person: 35,00 Euro/h
- number of persons: 1
- in total: 125,00 Euro/h

Ecological suitability

- Ecograms: bogies left without bends, right with bends

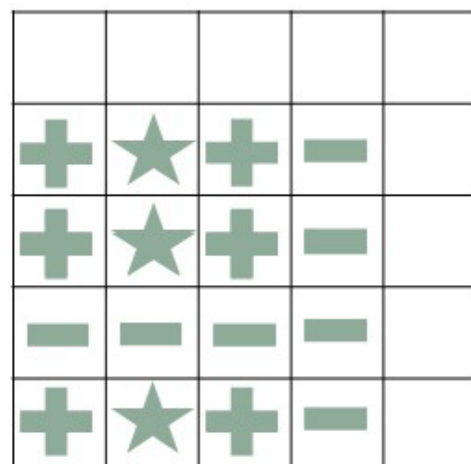
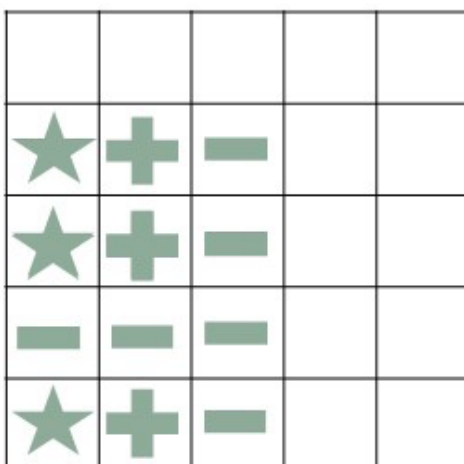

Social suitability:

- S-class: unloading tree length on the road > S3
- E-class: advanced machine work, moderate > E4

SP-22-32 mechanized skidding of tree lengths with skidder

Tree lengths that are pre-skidded to the trail are skidded to the forest road. This includes: setting chokers on several tree-lengths to optimize the load, skidding them to forest road, storing them alongside road or a landing.

Funciogram

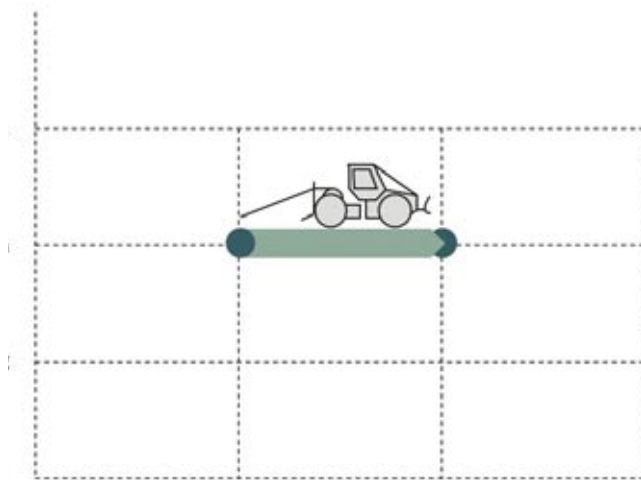

Advantages

- high productivity because of high mass/load
- versatile machine, esp. if farm-tractor based (farm work, snow work, transportation etc.)
- relatively cheap machine
- independent relocation

Limitations, thresholds

- damages in remaining stand at curves
- damage to ground (rutting)
- damage and dirt on logs

Main use

- extraction method when crosscutting should not be done before reaching the forest road (or the customer)
- very common method in broadleaved trees

Economic suitability

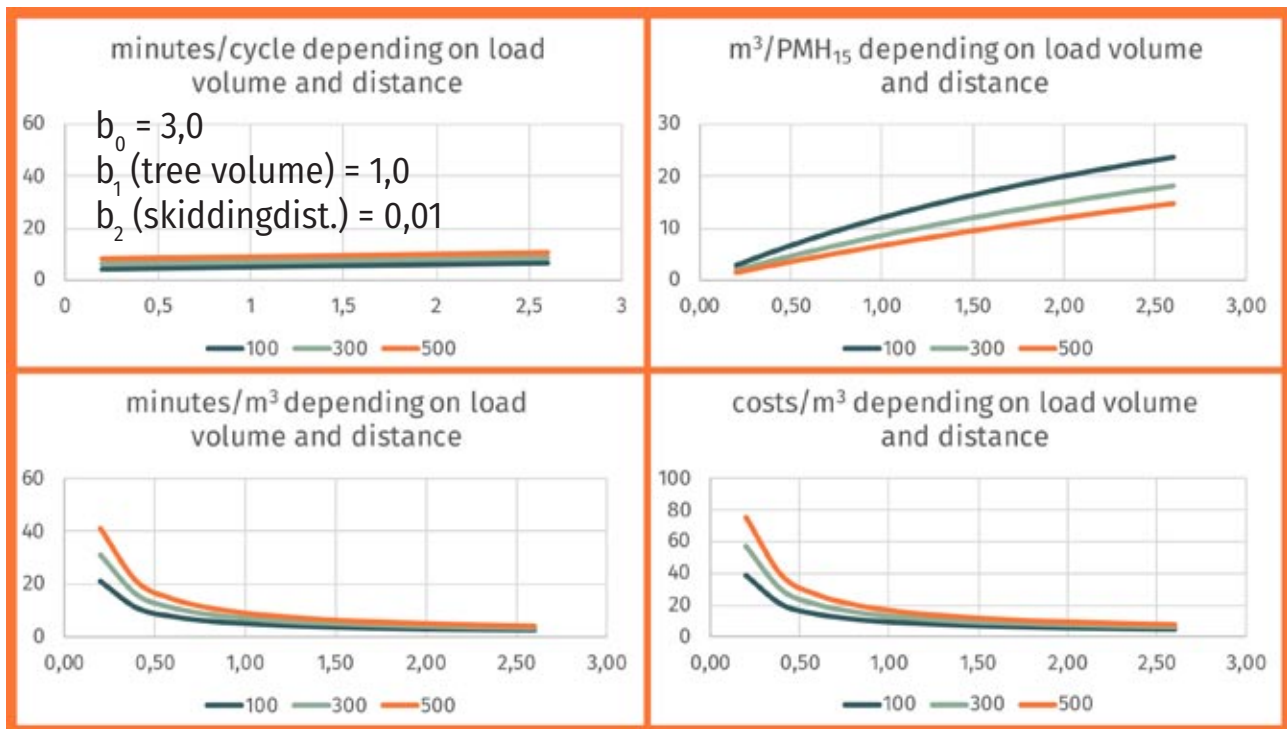

System costs (example)

- machine costs without personal costs: 40,00 Euro/h
- personal costs per person: 35,00 Euro/h
- number of persons: 2
- in total: 110,00 Euro/h

Ecological suitability

- Ecograms: wheels left without traction chains, right with traction chains

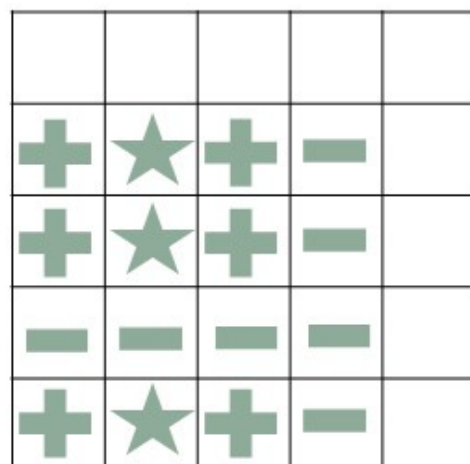
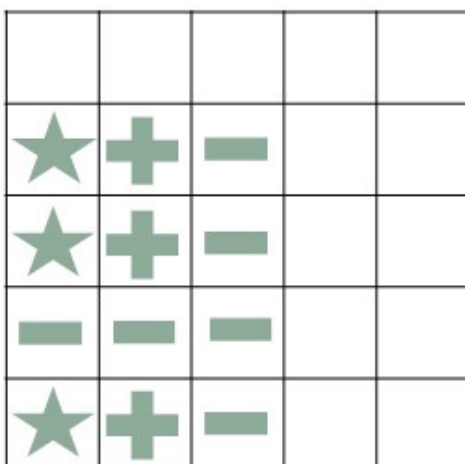

Social suitability:

- S-class: unloading tree length on the road > S3
- E-class: simple machine work, heavy and dangerous > E3

SP-22-33 mechanized forwarding of short logs with forwarder

Picking up logs that are stored alongside skid road, normally separating different assortments, forwarding them to forest road, unloading.

Funciogram

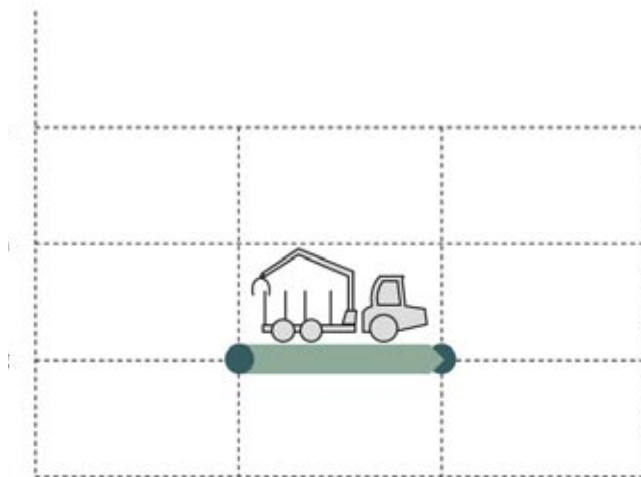

Advantages

- high performance
- ideal as a supplement to the harvester

Limitations, thresholds

- several passes on forest ground
- high ground pressure
- velocity and starting/slowing down in high frequency

Main use

- standard on trafficable stand and ground

Economic suitability

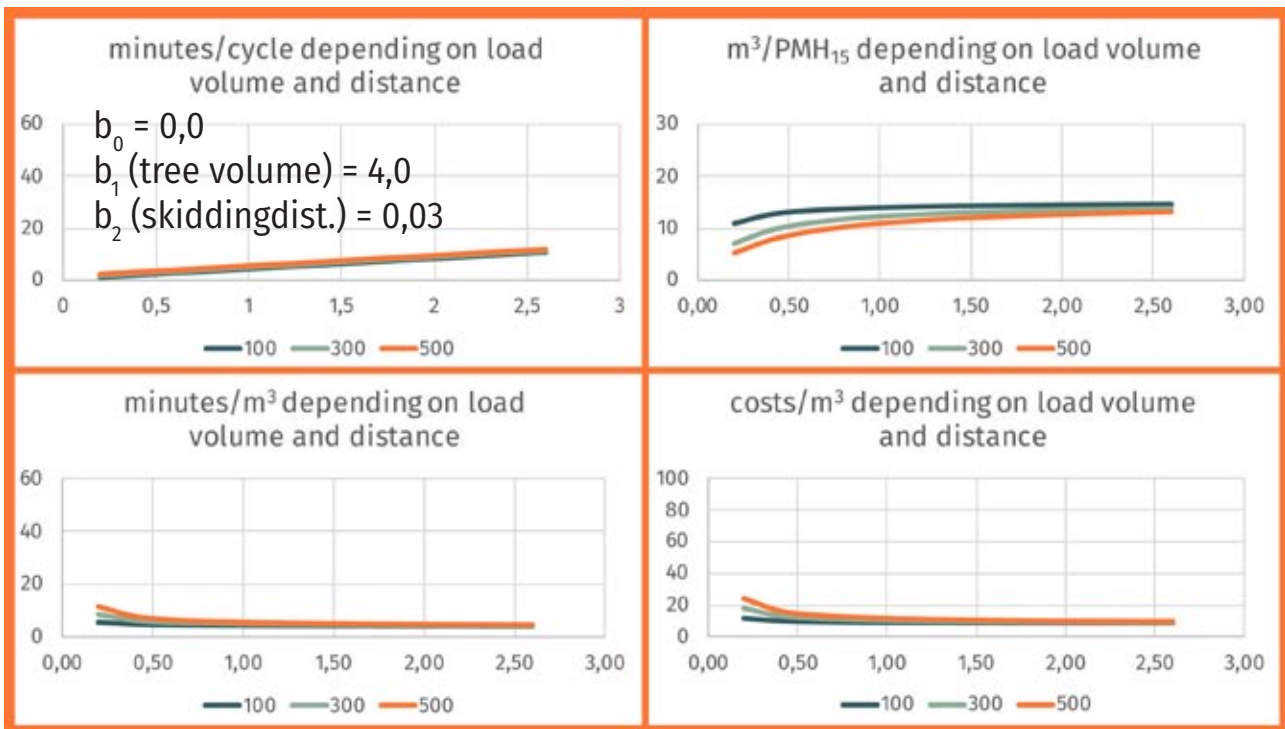

System costs (example)

- machine costs without personal costs: 90,00 Euro/h
- personal costs per person: 35,00 Euro/h
- number of persons: 1
- in total: 125,00 Euro/h

Ecological suitability

- Ecograms: bogies left without bends, right with bends

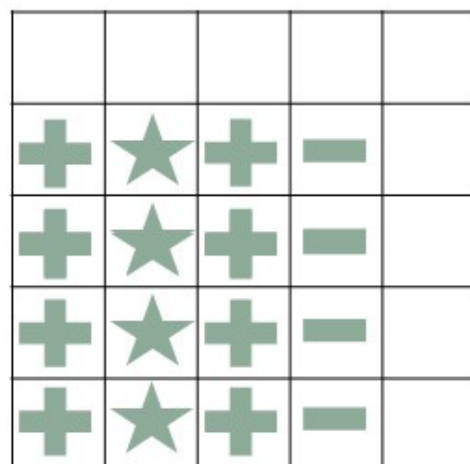
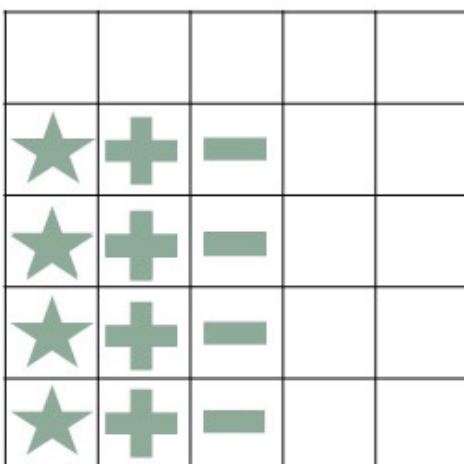

Social suitability:

- S-class: unloading short logs on the road > S4
- E-class: advanced machine work, moderate > E4

SP-23-33 mechanized forwarding of short logs with tractor and trailer

Picking up logs that are stored alongside skid road, normally separating different assortments, forwarding, unloading.

Funciogram

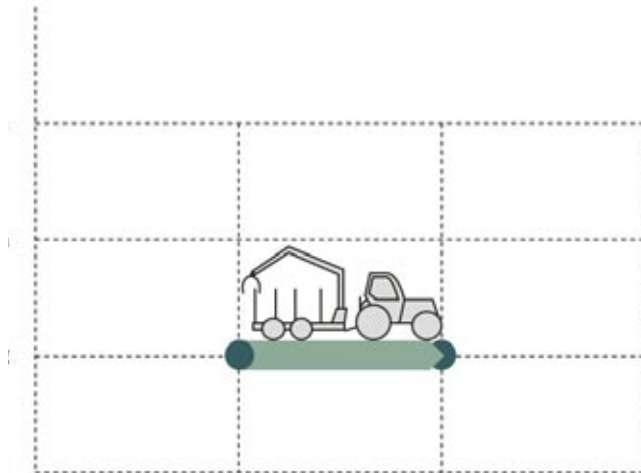

Advantages

- cheaper trailer combined with farm tractor, that can be utilized in better way
- tractor and trailer is faster than forwarder on roads and is road-legal in many countries – intermediate and short distance transportation

Limitations, thresholds

- lower performance than professional forwarder
- lower maximum load
- less off-road mobility than forwarder

Main use

- as combination in private forests, where the tractor is used for various purposes



Economic suitability

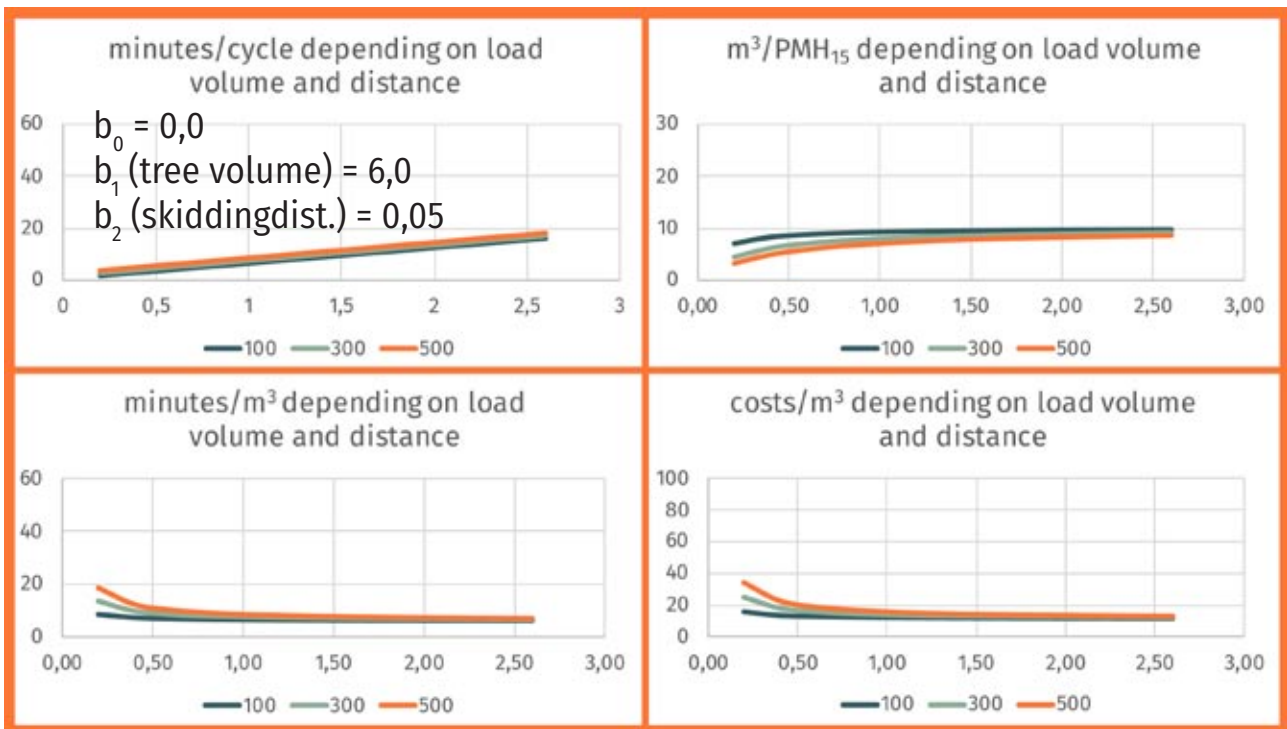

System costs (example)

- machine costs without personal costs: 75,00 Euro/h
- personal costs per person: 35,00 Euro/h
- number of persons: 1
- in total: 110,00 Euro/h

Ecological suitability

- Ecograms: wheels left without traction chains, right with traction chains

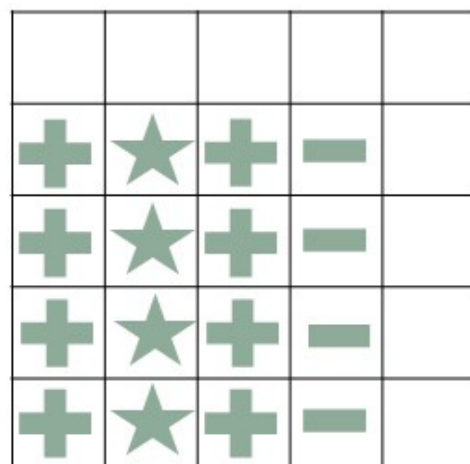
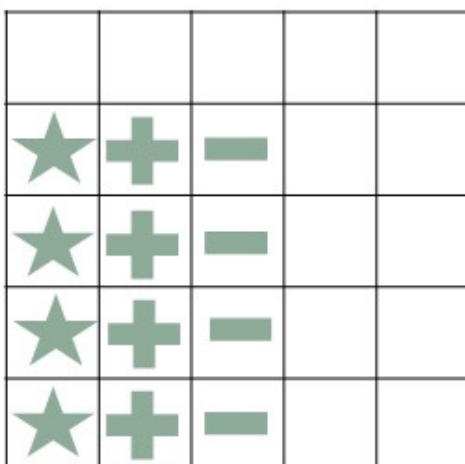

Social suitability:

- S-class: unloading short logs on the road > S4
- E-class: advanced machine work, moderate > E4

SP-23-34 mechanized chipping of residues on the trail

Logs are chipped by a self-propelled chipper or a tractor-powered chipper, fed by a loader. Chips are blown into a bin trailer, towed by the same tractor or by an accompanying machine. The most effective team is that composed by a self-propelled chipper with integrated loader and bin and a chip-shuttle (forwarder-based eg. Silvatec)

Funciogram

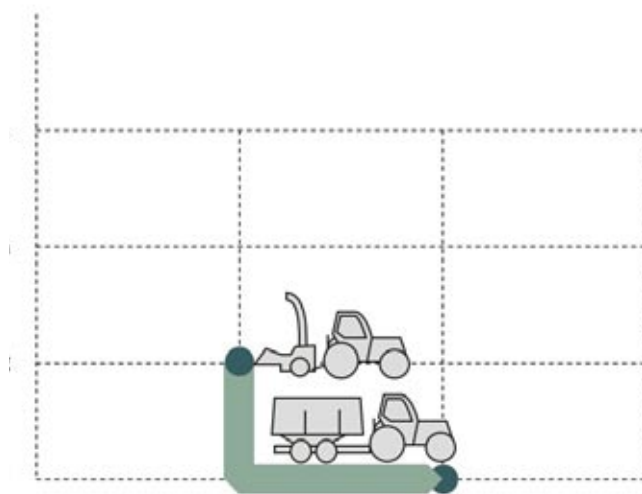

Advantages

- may facilitate replanting in clearcuts
- reduction of fuel loads
- chips are very clean, as the wood is not dragged and contaminated
- machines can move on a brash mat

Limitations, thresholds

- nutrient removal
- possible small volume concentration
- low product quality
- low productivity of terrain chippers compared with roadside chippers
- more terrain traffic with heavier units
- the interface between chipper and chip-shuttle can cause substantial interaction delays

Main use

- nordic countries
- poplar plantations



Economic suitability

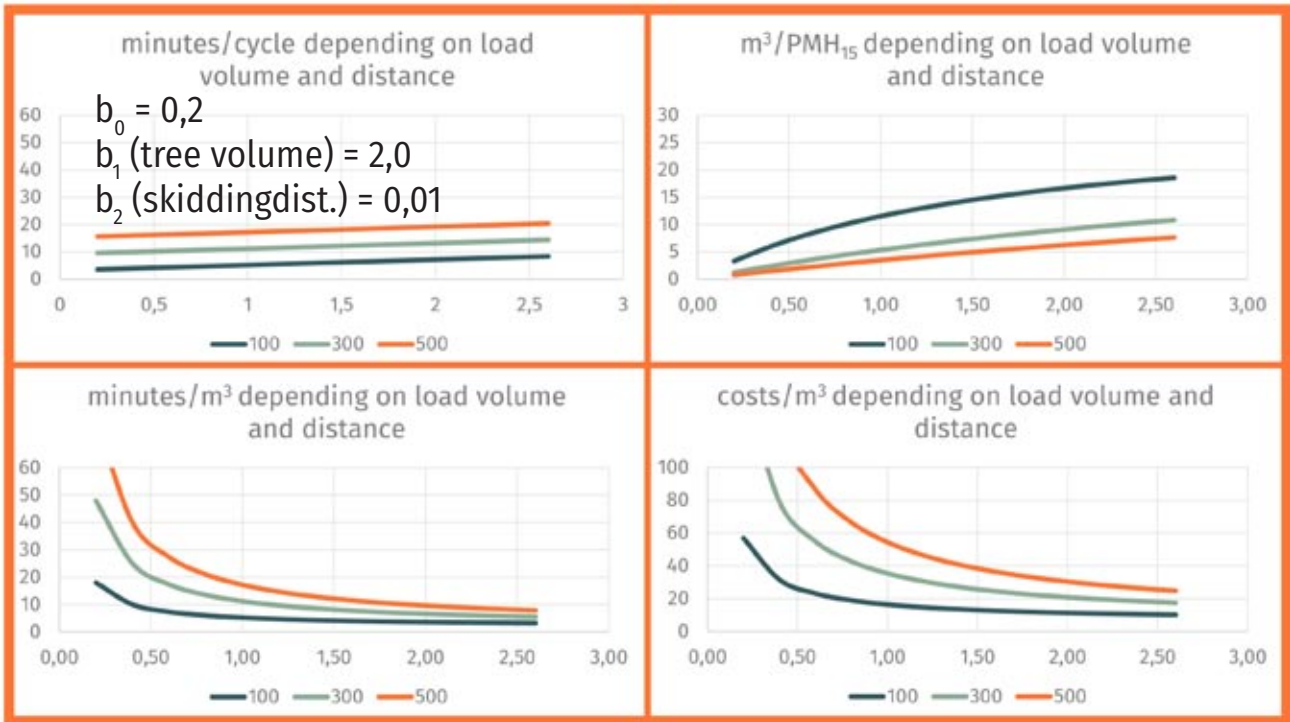

System costs (example)

- machine costs without personal costs: 120,00 Euro/h
- personal costs per person: 35,00 Euro/h
- number of persons: 2
- in total: 190,00 Euro/h

Ecological suitability

- Ecograms: wheels left without traction chains, right with traction chains

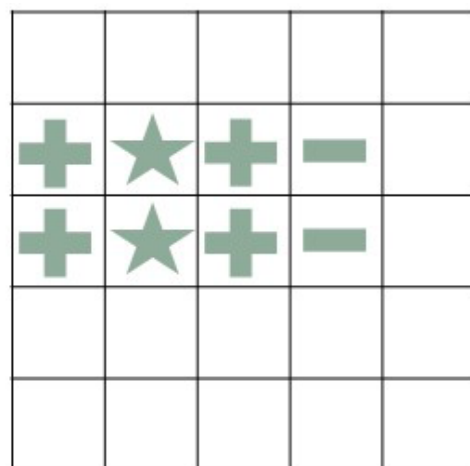
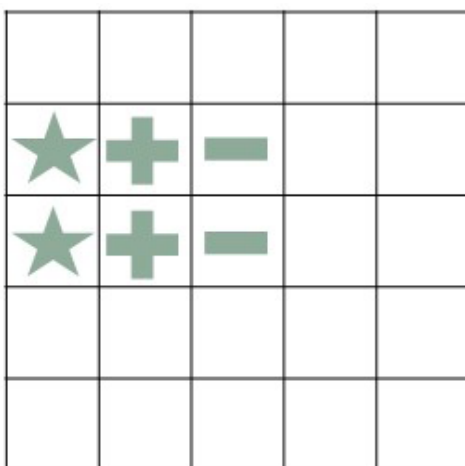

Social suitability:

- S-class: no contact with forest road > S5
- E-class: simple machine work, heavy and dangerous > E3

SP-31-33 mechanized processing on the forest road

Processor (or harvester) standing on forest road and processing the skidded full trees, which are stored.

Funciogram

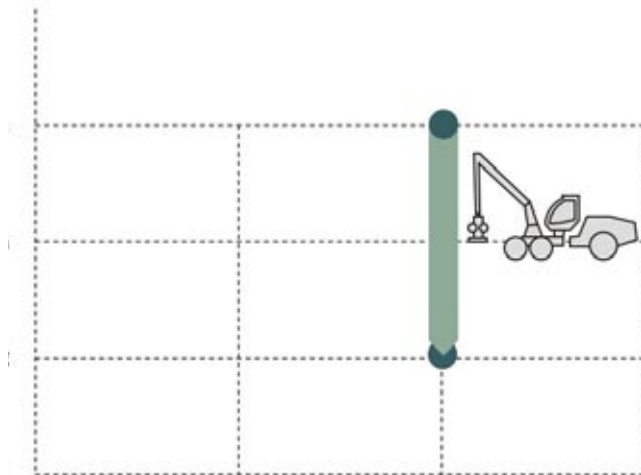

Advantages

- very high productivity
- perfect working site for driver
- opportunity to recover biomass at low cost

Limitations, thresholds

- place for storage gets full very quickly
- therefore needs an additional extraction machine like a forwarder
- risk for soil nutrient depletion

Main use

- where full trees are stored at forest road
- at windthrow or at cable ways
- standard option for modern cable-yarding operations

Economic suitability

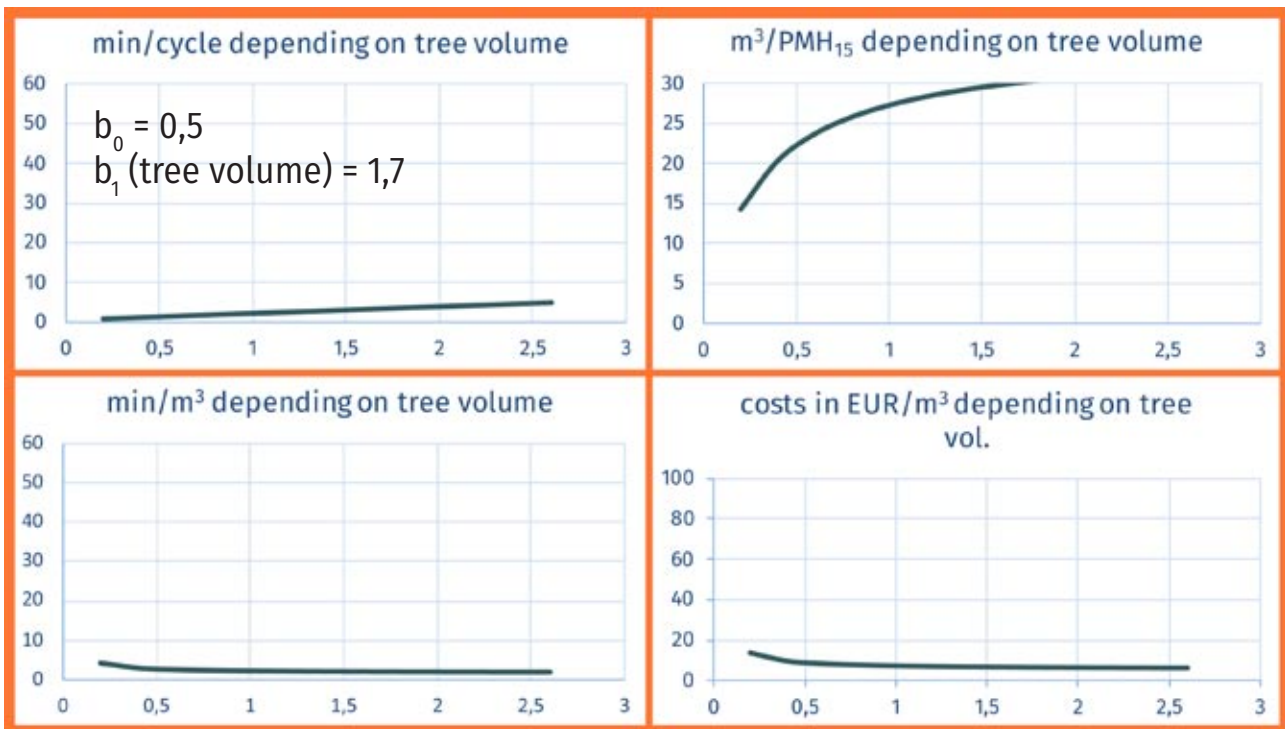

System costs (example)

- machine costs without personal costs: 160,00 Euro/h
- personal costs per person: 35,00 Euro/h
- number of persons: 1
- in total: 195,00 Euro/h

Ecological suitability

- Ecogram

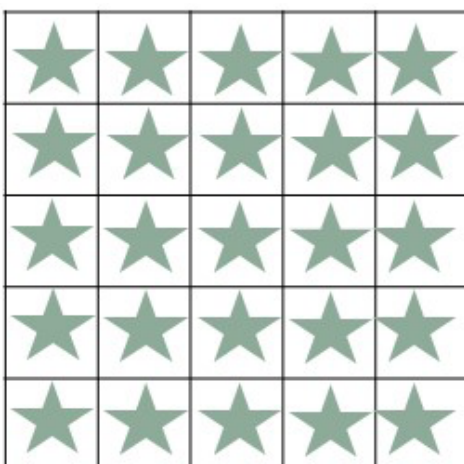

Social suitability:

- S-class: processing on forest road > S2
- E-class: advanced machine work, moderate > E4

SP-31-34 mechanized chipping of full trees at forest road

Full trees are chipped at a roadside landing.

Funciogram

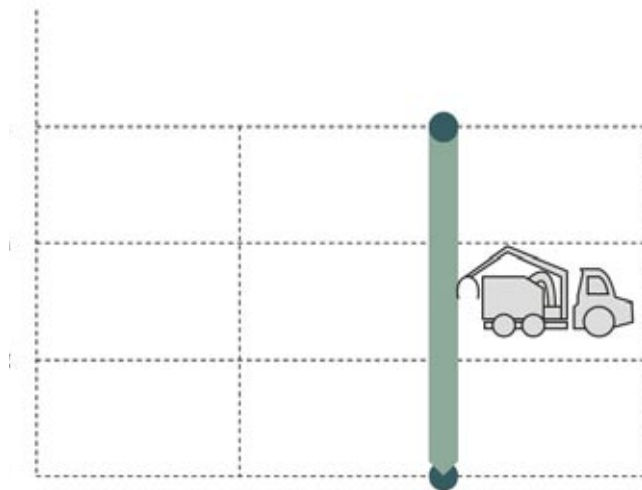

Advantages

- at the roadside, one can use very large and powerful chippers that will offer the highest productivity and lowest cost
- more biomass is recovered (around 20 to 30 %) compared with chipping logs

Limitations, thresholds

- whole-tree chips are of lower quality than chips obtained from delimbed logs, in terms of: particle size distribution, ash content, and storage capacity
- the roadside landing must be large enough to accommodate the chipper, the accompanying chipvan and the stacks to be chipped.
- stacks should not be contaminated during extraction and/or piling

Main use

- most chipping operations are conducted at roadside.
- whole trees are chipped when the quality of the stem (size, form, species) is not suitable for the cost-effective recovery of higher-value products
- in combination with cable yarder



Economic suitability

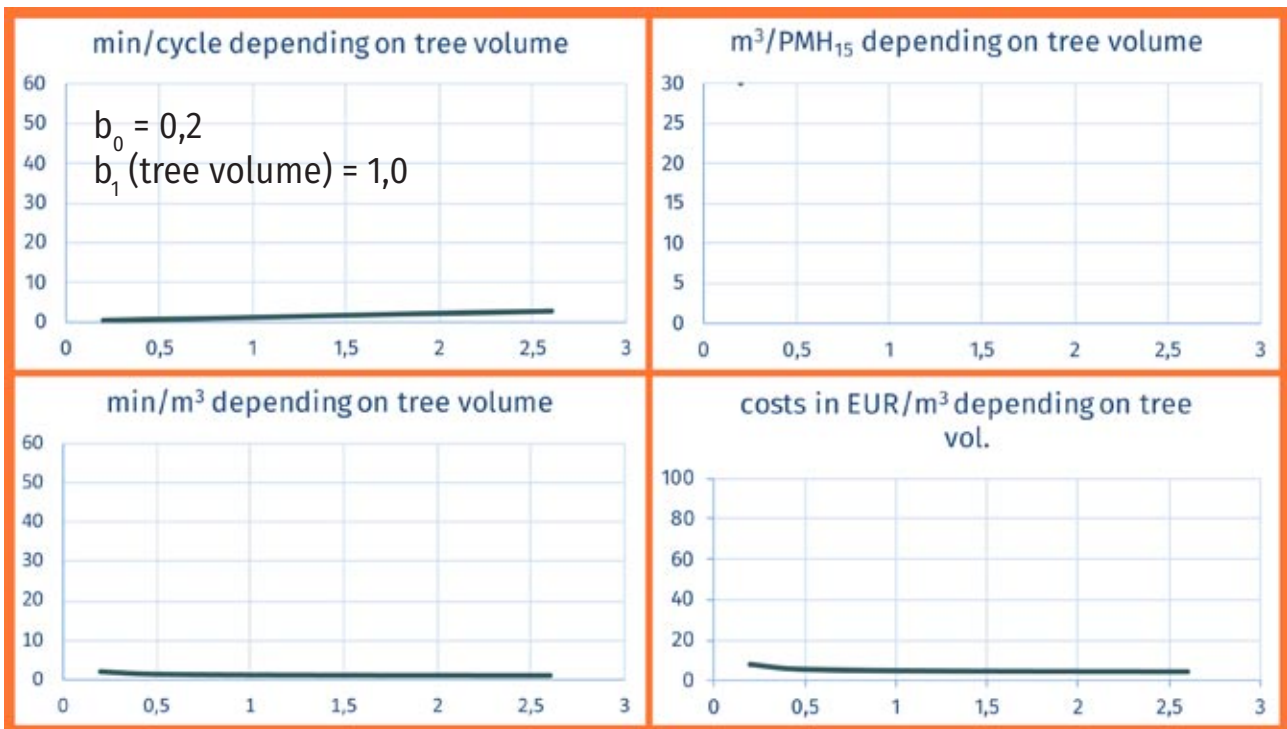

System costs (example)

- machine costs without personal costs: 200,00 Euro/h
- personal costs per person: 35,00 Euro/h
- number of persons: 1
- in total: 235,00 Euro/h

Ecological suitability

- Ecogram

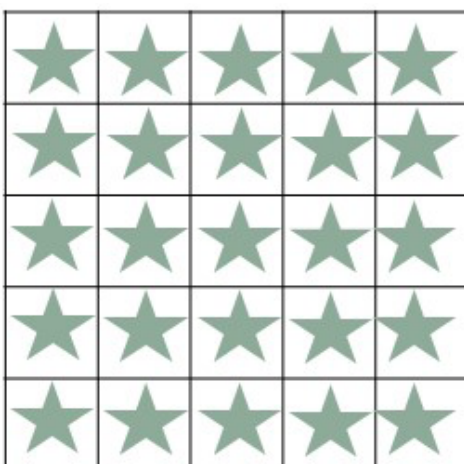

Social suitability:

- S-class: chipping on forest road > S1
- E-class: advanced machine work, moderate > E4

SP-32-34 mechanized chipping of tree lengths at forest road

Tree lengths that are stored at the forest road are chipped.

Funciogram

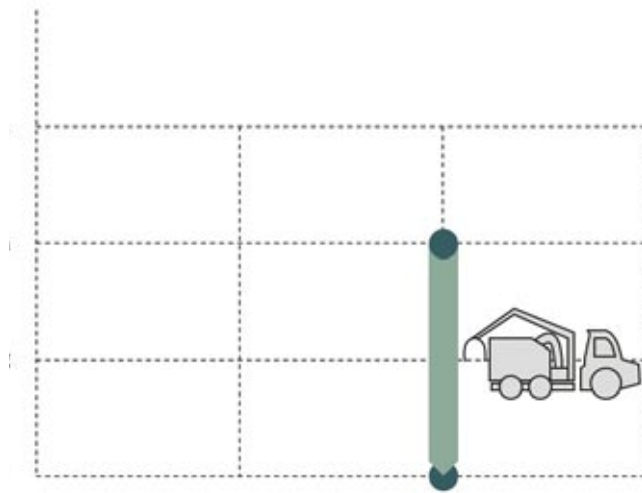

Advantages

- at the roadside, one can use very large and powerful chippers that will offer the highest productivity and lowest cost
- better quality than chipping of full trees

Limitations, thresholds

- the roadside landing must be large enough to accommodate the chipper, the accompanying chipvan and the stacks to be chipped.
- stacks should not be contaminated during extraction and/or piling

Main use

- most chipping operations are conducted at roadside.

Economic suitability

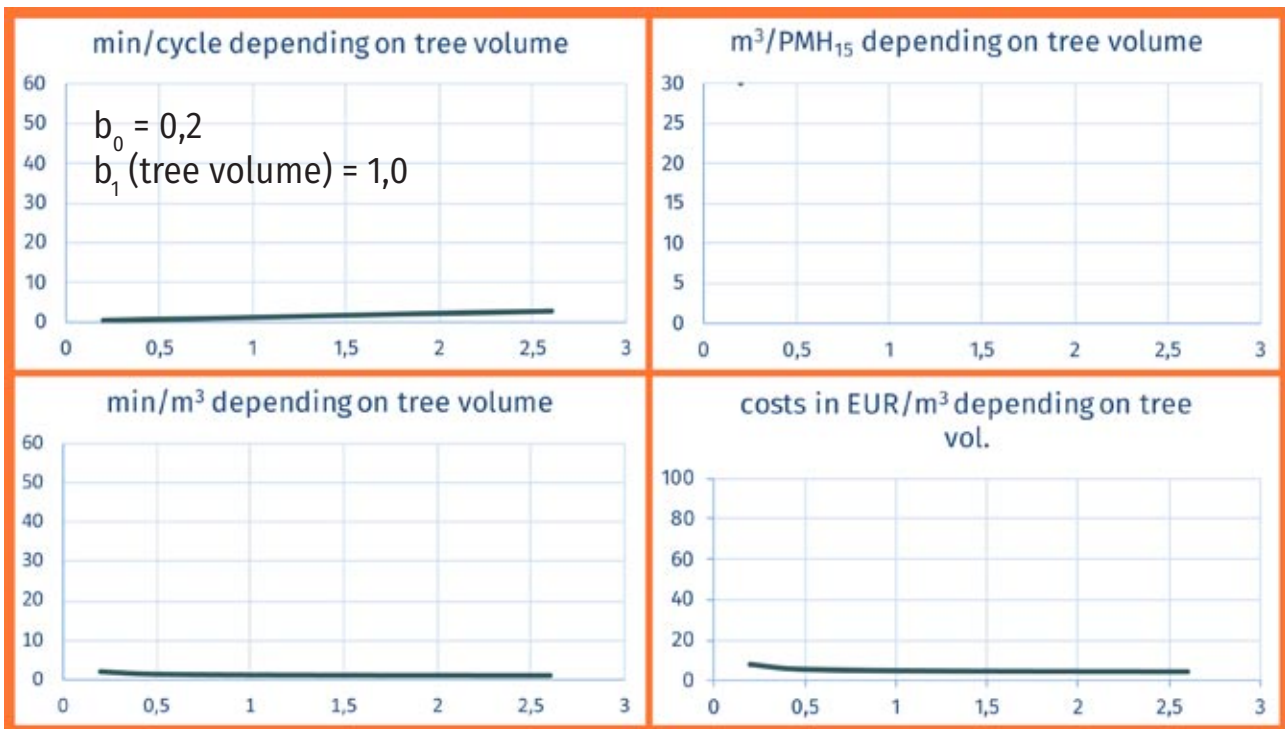

System costs (example)

- machine costs without personal costs: 200,00 Euro/h
- personal costs per person: 35,00 Euro/h
- number of persons: 1
- in total: 235,00 Euro/h

Ecological suitability

- Ecogram

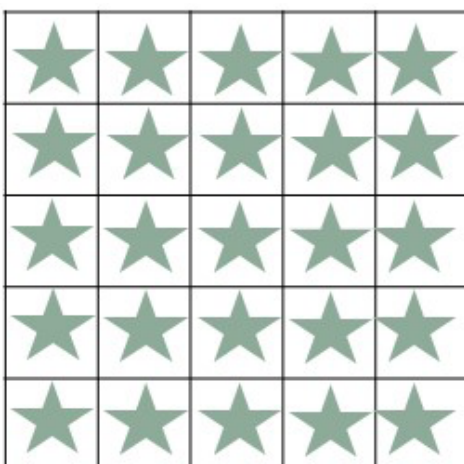

Social suitability:

- S-class: chipping on forest road > S1
- E-class: advanced machine work, moderate > E4

SP-33-34 mechanized chipping of logs at forest road

Logs are chipped from stacks piled at the roadside. The work can be done with any chipper, in any configurations. Chips can be discharged directly onto trucks, onto tractor-trailers or on the ground. Surge bins can also be used.

Funciogram

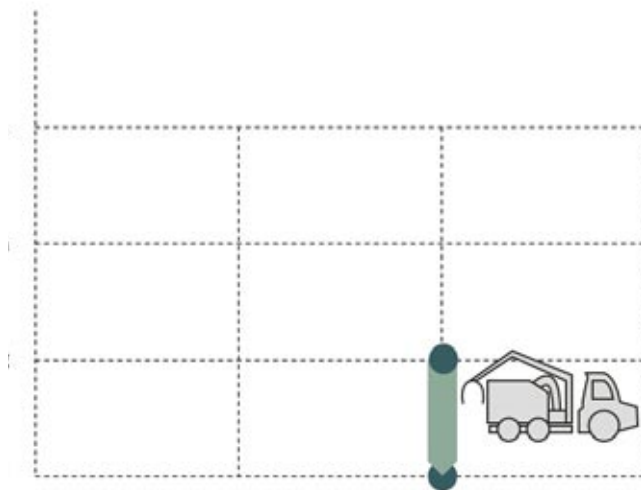

Advantages

- at the roadside, one can use very large and powerful chippers that will offer the highest productivity and lowest cost
- better quality than chipping of full trees

Limitations, thresholds

- the roadside landing must be large enough to accommodate the chipper, the accompanying chipvan and the stacks to be chipped.
- stacks should not be contaminated during extraction and/or piling

Main use

- most chipping operations
- chipping is more productive if performed at a roadside landing than in the stand because the material is more concentrated and one can use a larger machine



Economic suitability

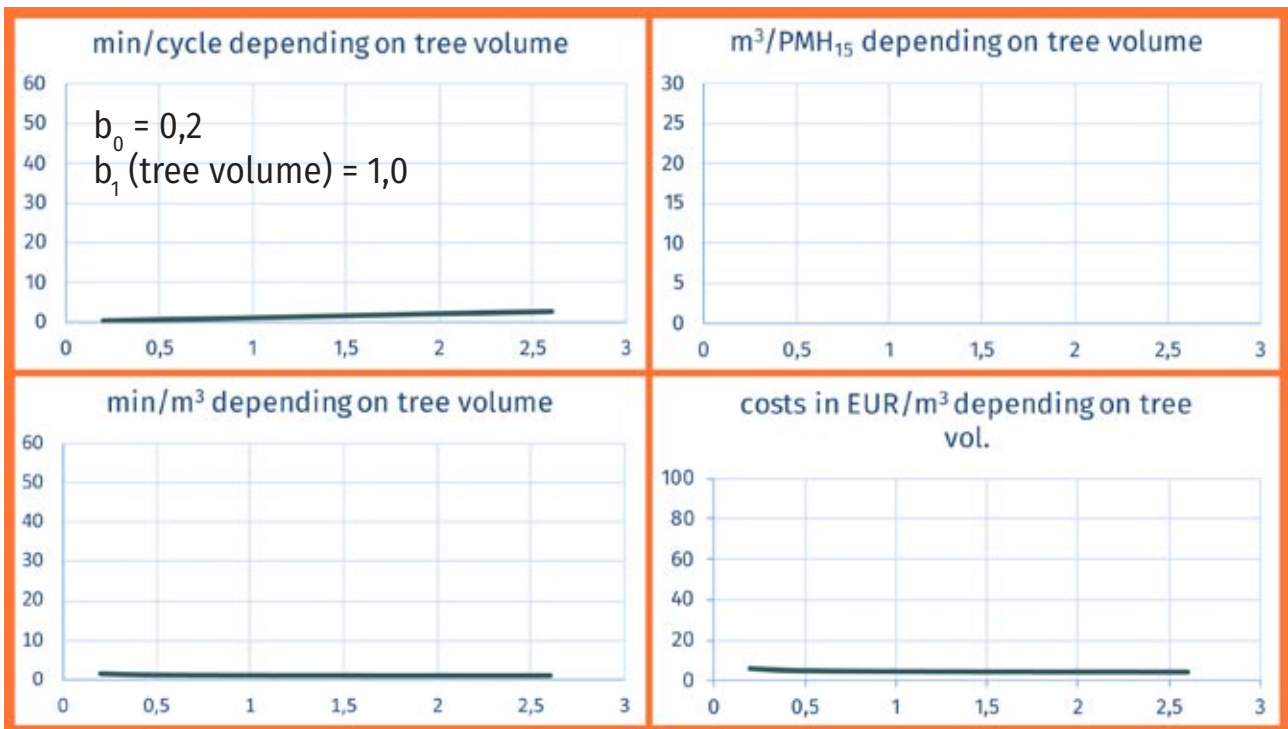

System costs (example)

- machine costs without personal costs: 200,00 Euro/h
- personal costs per person: 35,00 Euro/h
- number of persons: 1
- in total: 235,00 Euro/h

Ecological suitability

- Ecogram

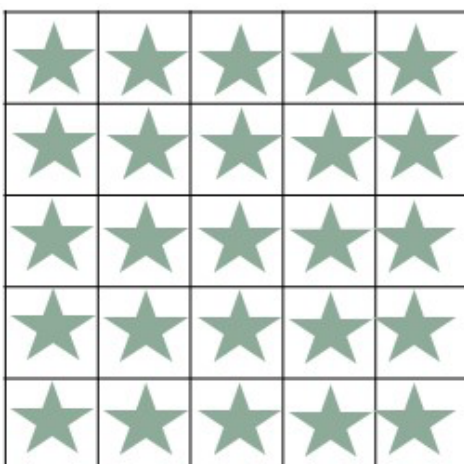

Social suitability:

- S-class: chipping on forest road > S1
- E-class: advanced machine work, moderate > E4

H INDEX

ability	78	cross-cutting, mechanized	108, 110, 142, 162
accident, risk	80	cross-cutting, motor-manual	102, 126
Ackerman steering	55	crosscut	17
additional costs	48	cut	20
AHP analytic hierarchy process	86	cut to length method	33
aim oriented level	24	damage	52
animal	22	decision-making	10, 13
assessment	7	degree of mechanization	24 , 27, 73
attribute	78	delimb	17
automatic work	27	delimiting, manual	114
auxiliary function	16	delimiting, mechanized	106, 108, 110, 142, 162
axe	20	delimiting, motor-manual	100, 102, 116
benefits	5	depreciation	40
biomass-harvester	112	distance of trails	64
bogie axles	55	drag	22
breaking down	7	E-class	80
buffer	19, 35	eco-efficiency	9
bush knife	20	ecogram	67
calculation of costs	37	ecological compatibility	9
capability	78	ecological effectiveness	9
carry	22	ecological efficiency	9
chainsaw	20, 98, 100, 102, 116, 126	ecological efforts	6
chip	17	ecological focus	91
chip method	33	ecological suitability	8, 51
chipper	150, 160, 164, 166, 168	economic effectiveness	9
chipping	112, 150, 160, 164, 166, 168	economic efficiency	9
chips	31	economic efforts	6
clam-bunk skidder	23, 144, 152	economic focus	90
compaction	58	economical suitability	8
complete tree	31	effectiveness	8 , 9, 37
conditioning	79	efficiency	8 , 9
corridor	18	employment	73
coverage	37	engineering formula	39
crane	22	equal weighting	89
criteria	7	ergonomics	9
		evaluation	7
		extract	16, 21



fell	16	maintenance costs	42
feller	20, 104	manner of working	77
felling damage	52	manual method (fully)	29, 30
felling site	18	manual work	25
felling, mechanized	104, 106, 108, 110, 112	map, technological	64
felling, motor-manual	98, 100, 102	maximize income	5
forest company	5	mechanization	24
forest road	18	mechanized method (fully)	29, 30
forest techniques	6	mechanized work	26
forestry	5	minimax rule	85
forward	21	monetarization	85
forwarder	23, 32, 156, 158	motor-manual method (fully)	29, 30
forwarding chips	112, 150, 160	motor-manual work	25
forwarding logs	110, 156, 158	normative level	13
frame steering	55	object state change	17
full tree	17, 31	objectives	7
full tree method	33	operational level	13, 24
functiogram	31	operational method	77
functional groups	33	optimal areas	96
functional system approach	12, 15	optimality	8
functions of harvesting	15	optimality curves	86
goods and services	5	option	10
grapple skidder	23, 146	P-class	65
hand	22	partly mechanized method	29, 30
hand saw	20	partly motor-manual method	29, 30
harvest	20	performance	45
harvester	20, 32, 106, 108, 142, 162	permanent rut	58
harvester biomass	112	permanent trail	61
harwarder	110	permanent work load	79
hierarchical system approach	13	portraits of sub-processes	97
horse	118, 128, 138	pre-skid	18, 21
informational level	24	pre-skidding with animal	118, 128, 138
interest costs	41	pre-skidding, manual	136
labor costs	44	pre-skidding, mechanized	120, 122, 124, 130, 132, 134, 140
local conditions	10	process	16
location change	16, 22	process chaining	34
log	17, 31	processing	142, 162
machete	20	processor	20, 142, 162
machine cost calculation	37, 43	productivity	45
		productivity class	65

readiness	78	techniques	6
recovery breaks	79	technogram	66
recovery of soil	61	technological map	64
recreation in the forest	74	three-step-model	10
regeneration of soil	59	time consumption	46
repair costs	42	total process	35
risk	52, 80	tractor	120, 122, 130, 140, 148, 158
rosette of decision-making	93	trafficability class	64
rut	58, 62	trail	18
S-class	75	trail spacing	69
saw	20	trailer for logs	158
scores	85	transport	18, 21
side-effect	52	tree length	17, 31, 56
skid	21	tree length method	33
skidder	23, 120, 122, 130, 140, 148, 154	tree mass	45
skidding	122, 124, 132, 134, 144, 146, 148, 152, 154	tree volume	45
skidding damage	55	tri-state model of soil	57
skill	78	truck	32
social effectiveness	9	ultimate goal	7
social efficiency	9	utility analysis	85
social efforts	6	variable costs	43
social focus	92	volume principle	45
social suitability	8, 81	winch	22, 120, 122, 130, 132, 140, 154
societal compatibility	9, 73	working method	77
soil moisture	64	working process	77
standard method	69, 77	written-off machine	49
state of the work object	16	yarder	22, 23, 124, 134
strain	78	zero-option	10
strategical level	13		
stress	77		
strip-road	18		
structural system approach	13		
sub-functions of harvesting	17		
sub-objectives	8		
sub-process	35 , 9		
system approach	12		
T-class	64		
tactical level	13		



Biodiversity
is the undisputed benchmark
for abundance of life and natural adap-
tation. The authors of this book believe that the
same should apply to wood harvesting technology in
the forest: In order to meet the risks and diverse require-
ments of the forest, the technology must be closely adapted
to the natural and social framework conditions and at the same
time observe the narrow economic limits. It is therefore the job of
the foresters to recognize and maintain niches and to deviate from
standards whenever they do not fit.

The basis is an ERASMUS+ project by six forestry faculties and two re-
search institutes, which together represent the diversity of European
forestry well. Together they coordinated their current knowledge and
their theories and prepared them in the form of an e-learning course.

There you can learn

- how to find suitable timber harvesting measures under
specific framework conditions,
- to assess them ecologically, socially and
economically
- and finally, to select the optimal
solution from among them.

The course is aimed at students of forest sciences at Master's level, but is also suitable for the
further training of forestry management personnel. Further information from the partners invol-
ved and links to further teaching content can also be found on this Moodle platform under:

technodiversity-moodle.ibe.cnr.it

This book is a condensed version of that course. It should help to repeat
what has been learned and to make it more available for daily work.

